

PART NUMBERING GUIDE - OSCILLATORS

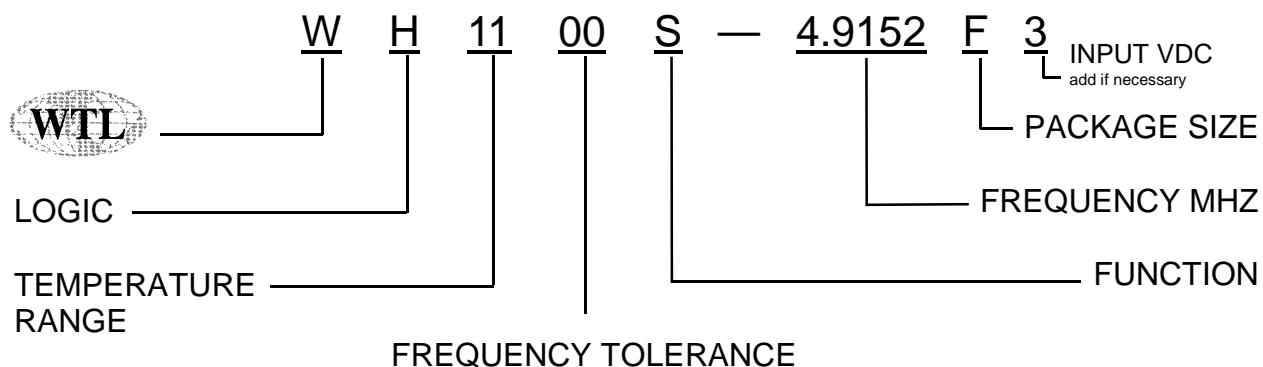

Part Numbering Definitions and Code

LOGIC	T = TTL
	C = CMOS
	H = HCMOS/TTL Compatible
	E = ECL 10 KH
	F = ECL 100 KH
TEMP RANGE:	11 = 0° to 70°C
	12 = -30° to 75°C
	13 = -40° to 85°C
	14 = -40° to 105°C
FREQ. TOL:	00 = 0.01% ± 100 ppm
	01 = 0.005% ± 50 ppm
	02 = 0.0025% ± 25 ppm
	03 = 0.002% ± 20 ppm
	04 = 0.0015% ± 15 ppm
	05 = 0.0010% ± 10 ppm
	06 = 0.0007% ± 7 ppm
FUNCTION:	S = Standard
	E = Enable/Disable (High) (TRI-STE, Pin One High)
	D = Dual Output
PACKAGE TYPE:	F = Full Size 14-Pin Dip Compatible 0.200" high
	LF = Low Profile Full Size 14-Pin Dip Compatible 0.179" high
	H = One Half Size 8-Pin Dip Compatible
	P = Plastic Surface Mount
	C = Ceramic Mount
	G = Gull Wing 1/2 Size 8-Pin Dip Surface Mount
INPUT-VOLTAGE:	3 = + 3.3 Volt DC ± 10% (Add 3 when necessary)

CRYSTAL CLOCK OSCILLATORS

WT1100S Series - TTL OUTPUT - 250.00 kHz TO 200.000 MHz

Description: A crystal controlled, thick film hybrid oscillator circuit which produces a TTL output characteristic at frequencies between 250kHz and 200.000MHz can drive up to 10 TTL loads. Input voltage at 3.3 VDC $\pm 5\%$ is available for battery/portable applications. Device is packaged in 8 or 14 pin Dip compatible case grounded to reduce RFI, resistance welded metal package.

SPECIFICATIONS

Frequency Range:	250KHz to 200.000MHz	
Frequency Stability:	$\pm 0.0010\%$ to $\pm 0.01\%$ over all conditions: calibration tolerance, operating temperature, input voltage change, aging, shock and vibration.	
Temperature Range:	Operating: 0°C to 70°C Storage: -55°C to $+125^{\circ}\text{C}$	
Input Voltage:	Rated $+5\text{VDC} \pm 10\%$	Operating $+4\text{VDC min}$ to $+7\text{VDCmax}$
Input Current:	250.0kHz to 19.9999MHz	30mA
	20.0MHz to 29.9999MHz	55mA
	60.0MHz to 89.9999MHz	80mA
	90.0MHz to 200.0000MHz	90mA

HCMOS Output:
 Symmetry: $50\% \pm 10\%$ at 1.4VDC level
 Rise & Fall Times: 8ns max. for 250kHz to 25MHz
 6ns max. to 25MHz to 70MHz
 3ns max. for 70MHz to 100MHz
 "0" Level: +0.4 volts max.
 "1" Level: +2.4volts min.
 Output Load: 1 to 10 TTL gates (1.6mA per gate)

PACKAGES

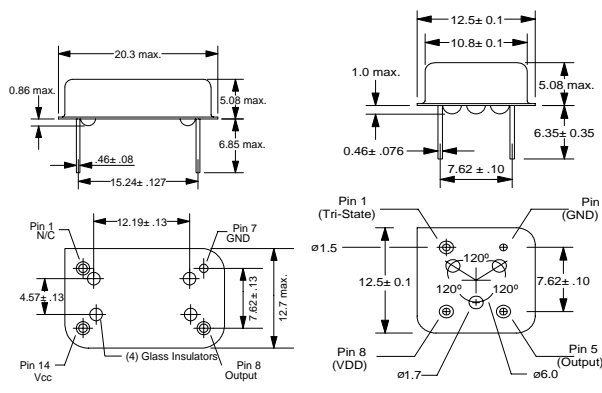

PIN	CONNECTION
1	N.C.
7	GND
8	OUTPUT
14	+V DC

PIN	CONNECTION
1	N.C.
4	GND
5	OUTPUT
8	+V DC

TEST CIRCUIT DIAGRAM FOR TTL COMPATIBLE

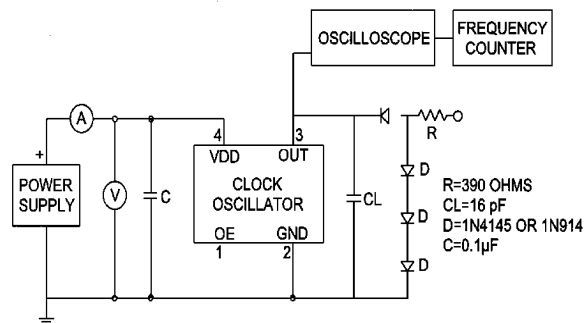

Standard Marking Format

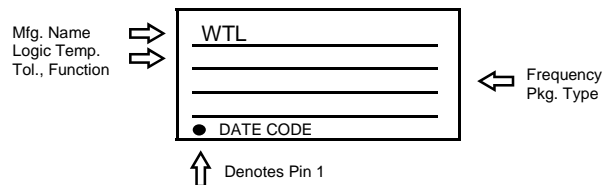

OUTPUT WAVEFORM

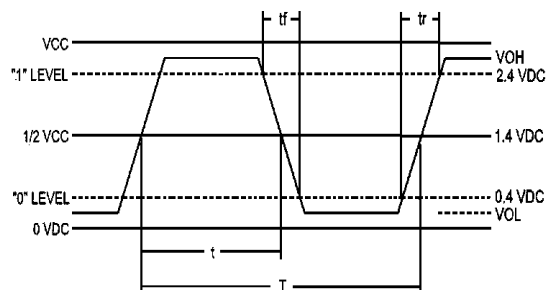

MECHANICAL/ENVIRONMENTAL

SHOCK: MIL-STD-202F, Method 213B, Cond. E, 1000 G's .35mS, 1/2 Sine Wave
 VIBRATION: MIL-STD-202F, Method 204, 35G, 50 to 2000Hz
 HERMETICITY: Leak Rate $< 2 \times 10^8$ ATM, cc/Sec of helium,
 HUMIDITY: 85% relative humidity, 85°C , 48 hours
 STORAGE: -55° to 125°C

Part Numbering Guide: See Attached



CRYSTAL CLOCK OSCILLATORS

Full Size Package — 14 PIN DIP

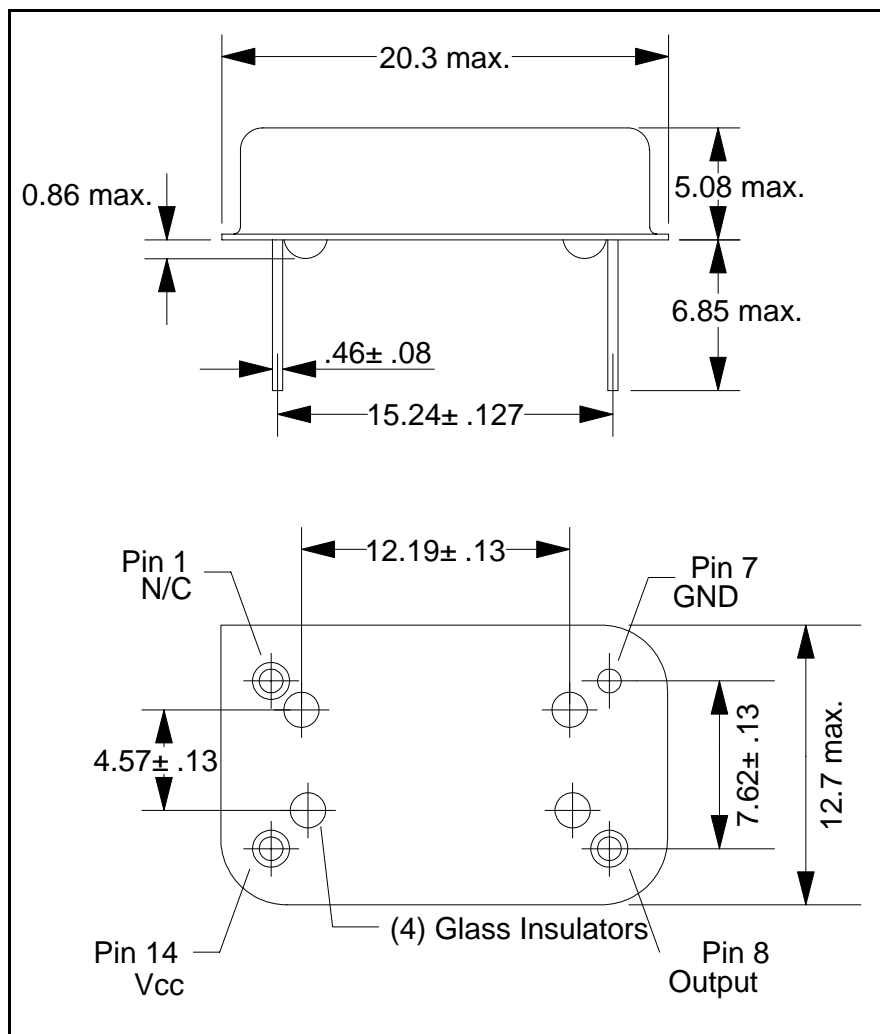

Enlarged View

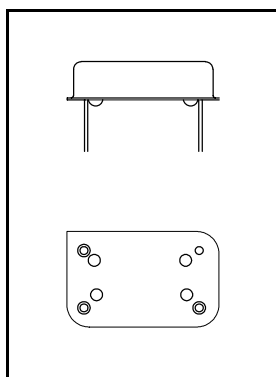

Actual Size Shown Above 1=1

CRYSTAL CLOCK OSCILLATORS

WC1100S Series - CMOS OUTPUT - 250.00 kHz TO 72.000 MHz

Description: A crystal controlled, low current hybrid oscillator circuit providing precise rise and fall times to drive CMOS and NMOS microprocessors. Compatible with both CMOS and TTL. Can drive up to 2 LSTTL loads. Input voltage at 3.3 VOC ±5% is available for battery/portable applications. Device is packaged in 8 or 14 pin Dip compatible case grounded to reduce RFI, resistance welded

SPECIFICATIONS

Frequency Range:	250KHz to 72.000000MHz	
Frequency Stability:	±0.0010% to ±0.01% over all conditions: calibration tolerance, operating temperature, input voltage change, aging, shock and vibration.	
Temperature Range:	Operating: 0°C to 70°C Storage: -55°C to + 125°C	
Input Voltage:	Rated +5VDC ±10%	Operating +4VDC min +7VDCmax
Input Current:	250.0kHz to 24.0MHz	20mA 24.0MHz to 40.0MHz 35mA 40.0MHz to 72.0MHz 45mA
HCMOS Output:	Symmetry: 50% ± 10% at 50% V _{DD} Rise & Fall Times: 10% V _{DD} to 90% V _{DD} : 5ns max. (1TTL) 0.5 V to 2.5 V: 5 ns max. (1 TTL) "0" Level: V _{SS} + 0.5 V max. "1" Level: V _{DD} - 0.5 V min.	

PACKAGES

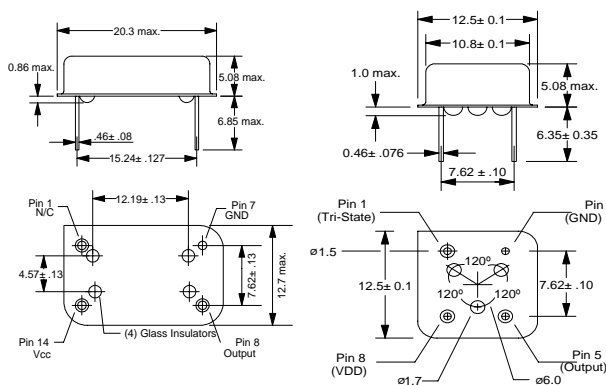

PIN	CONNECTION
1	N.C.
7	GND
8	OUTPUT
14	+V DC

PIN	CONNECTION
1	N.C.
4	GND
5	OUTPUT
8	+V DC

TEST CIRCUIT DIAGRAM

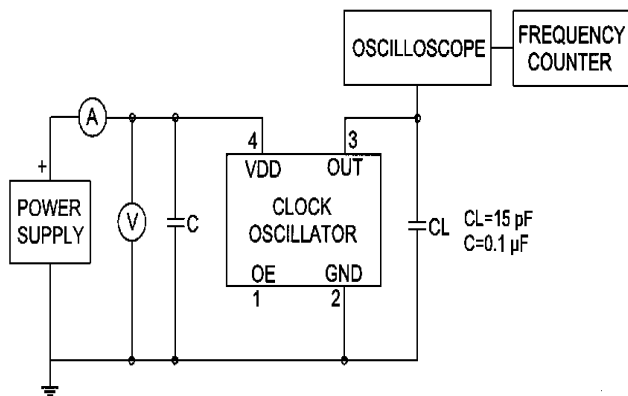

Standard Marking Format

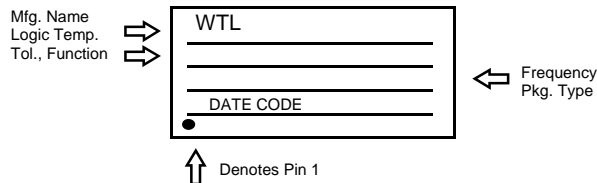

OUTPUT WAVEFORM

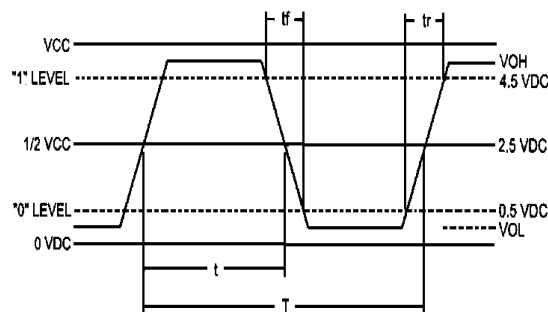

MECHANICAL/ENVIRONMENTAL

SHOCK: MIL-STD-202F, Method 213B, Cond. E, 1000 G's .35ms, 1/2 Sine Wave
 VIBRATION: MIL-STD-202F, Method 204, 35G, 50 to 2000Hz
 HERMETICITY: Leak Rate < 2 x 10⁸ ATM, cc/Sec of helium,
 HUMIDITY: 85% relative humidity, 85°C, 48 hours
 STORAGE: -55° to 125°C

Part Numbering Guide: See Attached

CRYSTAL CLOCK OSCILLATORS

Half Size Package — 8 PIN DIP

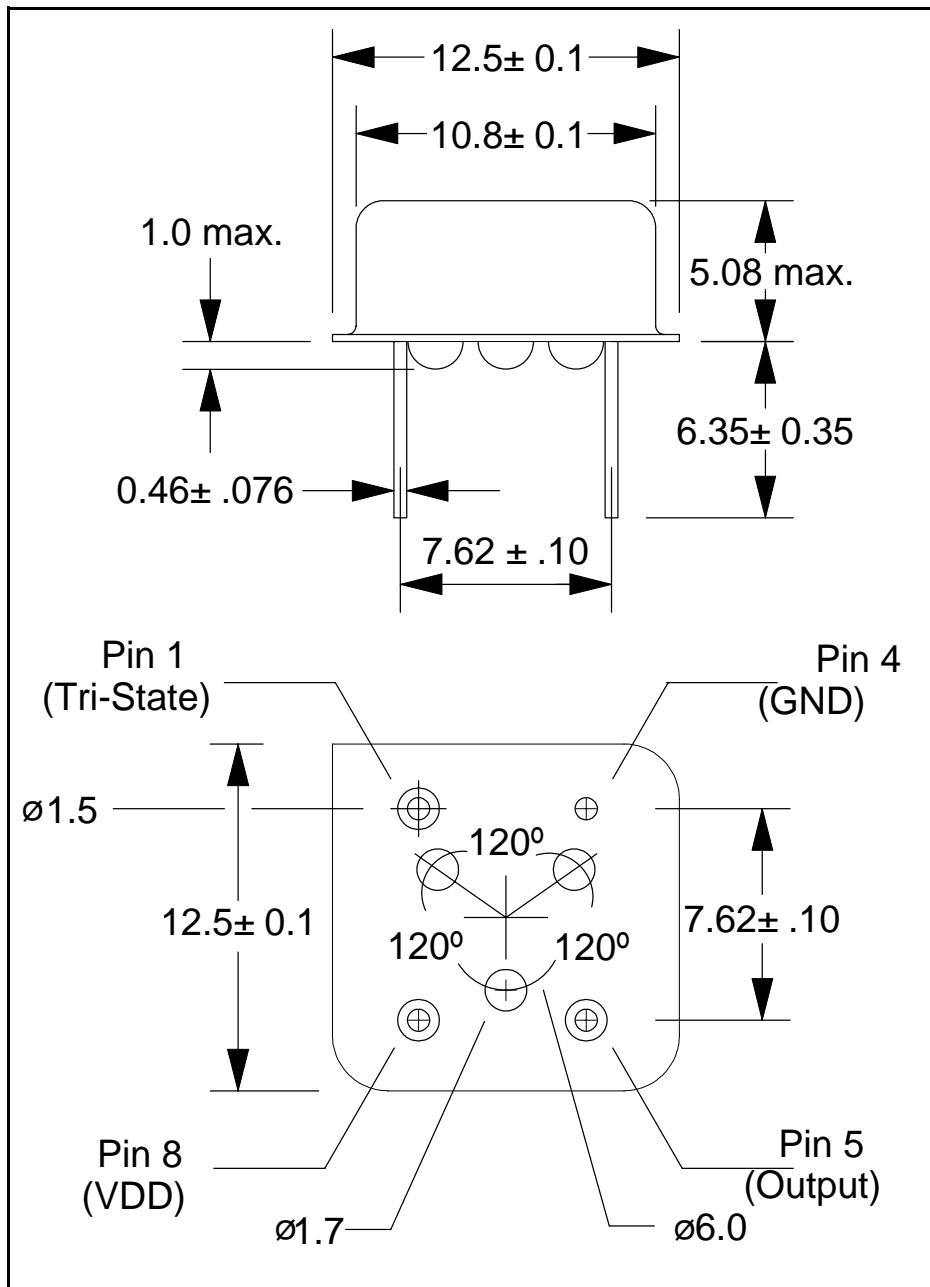

Enlarged View

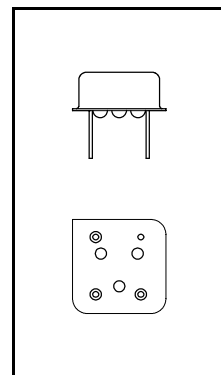

Actual Size Shown Above 1=1

CRYSTAL CLOCK OSCILLATORS

WH1100S Series - High Speed CMOS OUTPUT - 250.00 kHz TO 200.000 MHz

WH1102E-10.24HS

WTL Part No.

Description: A crystal controlled, low current hybrid oscillator circuit providing precise rise and fall times to drive high speed CMOS and NMOS microprocessors. Compatible with both high speed CMOS and TTL. Can drive up to 10 TTL loads. Input voltage at 3.3 VOC ±5% is available for battery/portable applications. Device is packaged in 8 or 14 pin Dip compatible case grounded to reduce RFI, resistance welded metal package.

SPECIFICATIONS

Frequency Range: 250KHz to 200.000MHz
 Frequency Stability: ±0.0010% to ±0.01% over all conditions: calibration tolerance, operating temperature, input voltage change, aging, shock and vibration.

Temperature Range:
 Operating: 0°C to 70°C
 Storage: -55°C to + 125°C

Input Voltage: Rated Operating
 +5VDC ±10% +4VDC min +7VDCmax

Input Current: 250.000kHz to 3.4999MHz 10mA (Max)
 3.500MHz to 29.9999MHz 15mA (Max)
 30.000MHz to 69.9999MHz 30mA (Max)
 70.000MHz to 200.000MHz 80mA (Max)

HCMOS Output:
 Symmetry: 50% ± 5% at 50% VDD
 Rise & Fall Times: (10 TTL Loads):
 20% to 80% VDD: Tr = 4 ns max, Tf = 4 ns max
 0.5 V to 2.5 V: Tr = 6ns max, Tf = 4 ns max
 "0" Level: VSS + 0.5 V max.
 "1" Level: VDD - 0.5 V min.

PACKAGES

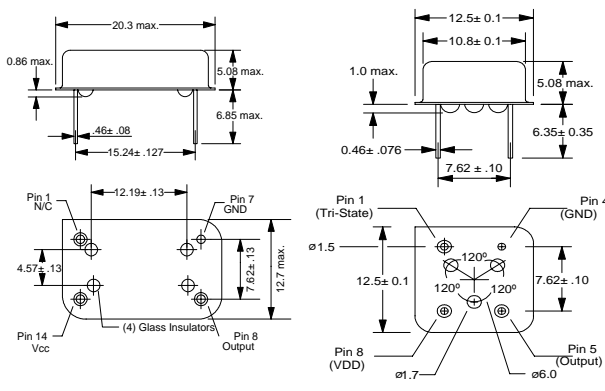

PIN	CONNECTION
1	N.C.
7	GND
8	OUTPUT
14	+V DC

PIN	CONNECTION
1	N.C.
4	GND
5	OUTPUT
8	+V DC

TEST CIRCUIT DIAGRAM

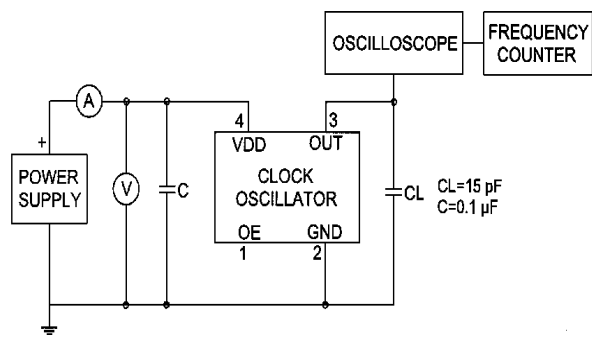

Standard Marking Format

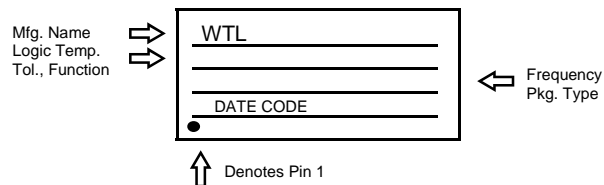

OUTPUT WAVEFORM

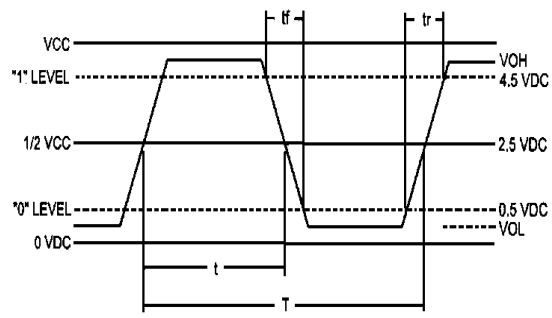

MECHANICAL/ENVIRONMENTAL

SHOCK: MIL-STD-202F, Method 213B, Cond. E, 1000 G's .35S, 1/2 Sine Wave
 VIBRATION: MIL-STD-202F, Method 204, 35G, 50 to 2000Hz
 HERMETICITY: Leak Rate < 2 x 10⁸ ATM, cc/Sec of helium,
 HUMIDITY: 85% relative humidity, 85°C, 48 hours
 STORAGE: -55° to 125°C

Part Numbering Guide: See Attached

CRYSTAL CLOCK OSCILLATORS

Full Size Package — 14 PIN DIP

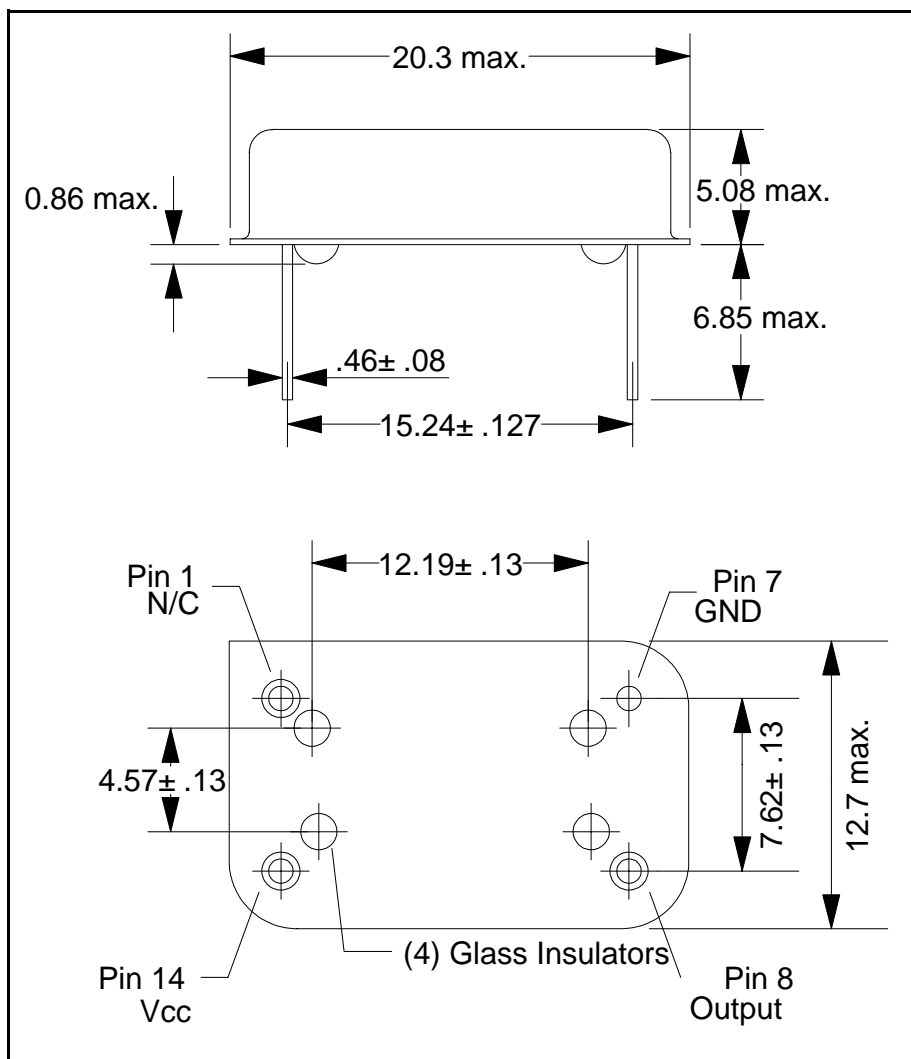

Enlarged View

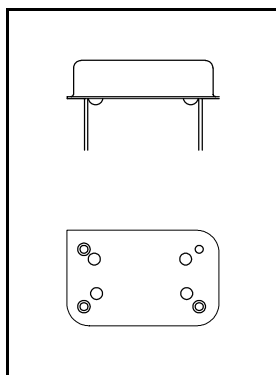

Actual Size Shown Above 1=1

CRYSTAL CLOCK OSCILLATORS

WH1100E Series - High Speed CMOS Output (Enable/Disable) - 250.00 kHz TO 200.000 MHz

WH1102E-10.24HS

WTL Part No.

Description: A crystal controlled, thick film hybrid oscillator circuit providing precise rise and fall times to drive high speed CMOS and NMOS microprocessors. Compatible with both high speed CMOS and TTL. Can drive up to 10 TTL loads. This series of clock oscillators employs an Enable/Disable function for control of the output. Applying a logic "1" to pin 1 enables the oscillator output and a logic "0" applied to pin 1 disables the output to a high impedance state. Input voltage at 3.3 VOC ±5% is available for battery/portable applications. Device is packaged in 8 or 14 pin Dip compatible case grounded to reduce RFI, resistance welded metal package.

SPECIFICATIONS

Frequency Range: 250KHz to 200.000MHz
 Frequency Stability: ±0.0010% to ±0.01% over all conditions: calibration tolerance, operating temperature, input voltage change, aging, shock and vibration.

Temperature Range:
 Operating: 0°C to 70°C
 Storage: -55°C to + 125°C

Input Voltage:	Rated	Operating
	+5VDC ±10%	+4VDC min 7VDCmax
Input Current:	250.000kHz to 3.4999MHz	10mA (Max)
	3.500MHz to 29.9999MHz	15mA (Max)
	30.000MHz to 69.9999MHz	30mA (Max)
	70.000MHz to 200.000MHz	80mA (Max)

HCMOS Output:
 Symmetry: 50% ± 5% at 50% VDD
 Rise & Fall Times: (10 TTL Loads):
 20% to 80% V_{DD}: T_r = 4 ns max, T_f = 4 ns max
 0.5 V to 2.5 V: T_r = 6ns max, T_f = 4 ns max
 "0" Level: V_{SS} + 0.5 V max.
 "1" Level: V_{DD} - 0.5 V min.

PACKAGES

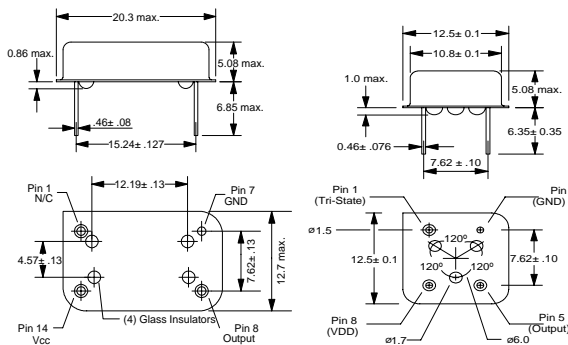

PIN	CONNECTION
1	N.C. E/D
7	GND
8	OUTPUT
14	+V DC

PIN	CONNECTION
1	N.C. E/D
4	GND
5	OUTPUT
8	+V DC

OUTPUT WAVEFORM

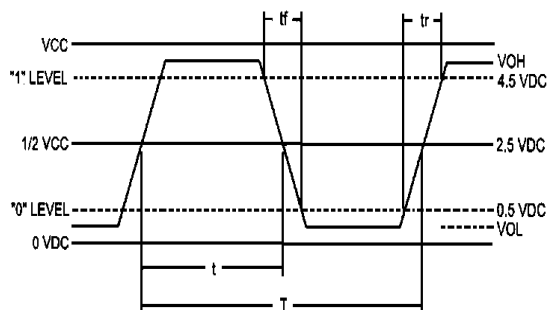

TEST CIRCUIT DIAGRAM

FOR TTL COMPATIBLE

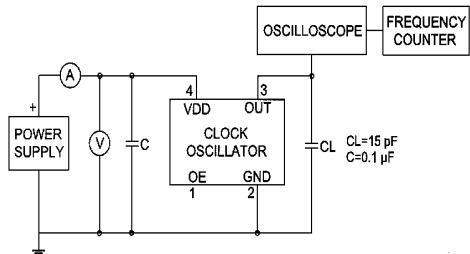

Standard Marking Format

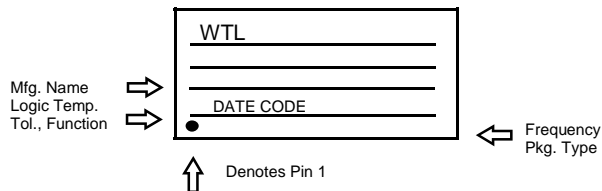

MECHANICAL/ENVIRONMENTAL

SHOCK: MIL-STD-202F, Method 213B, Cond. E, 1000 G's .35S, 1/2 Sine Wave
 VIBRATION: MIL-STD-202F, Method 204, 35G, 50 to 2000Hz
 HERMETICITY: Leak Rate < 2 x 10⁸ ATM, cc/Sec of helium,
 HUMIDITY: 85% relative humidity, 85°C, 48 hours
 STORAGE: -55° to 125°C

Part Numbering Guide: See Attached

CRYSTAL CLOCK OSCILLATORS

Half Size Package — 8 PIN DIP

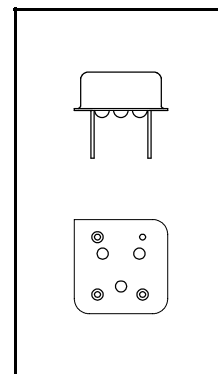
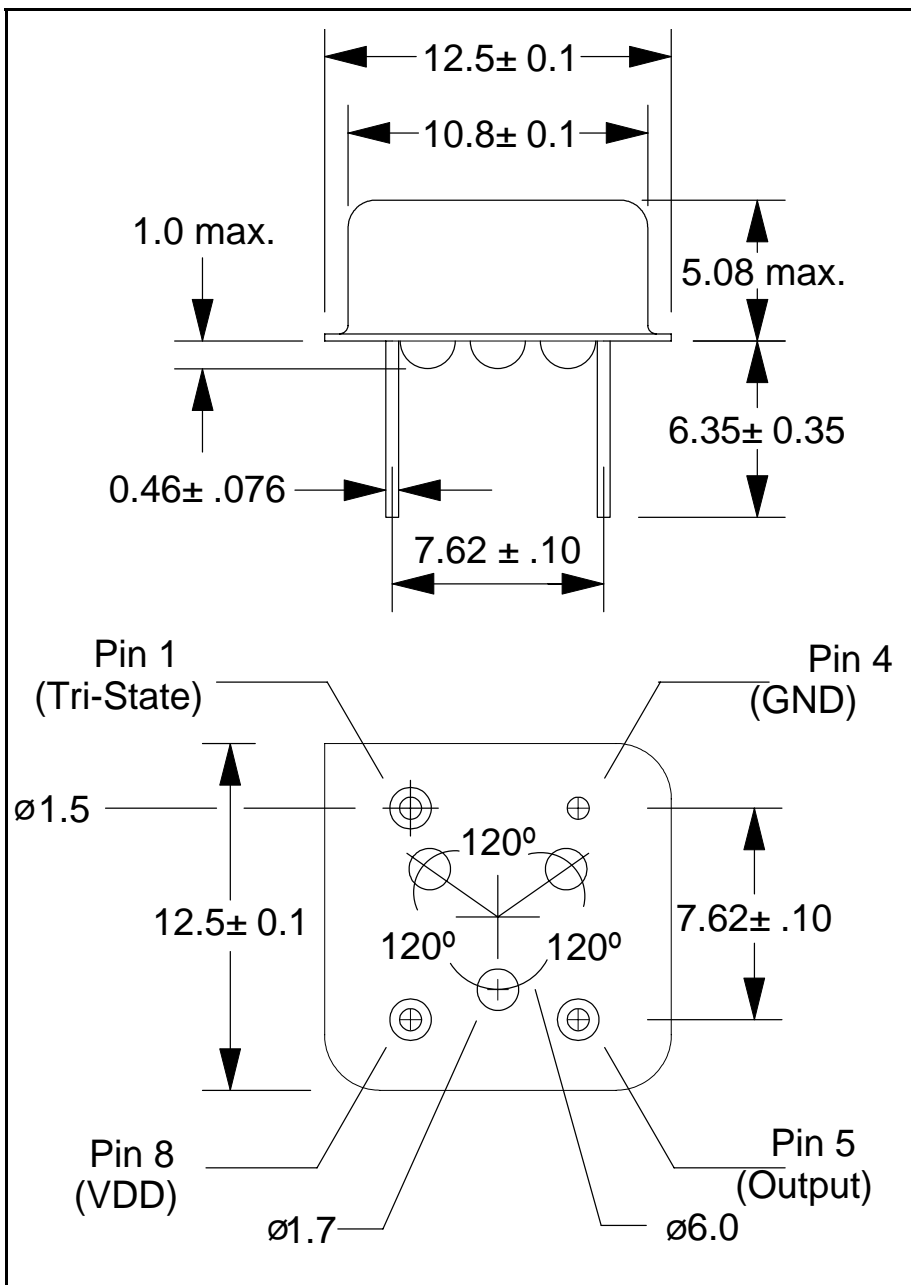

Actual Size Shown Above 1=1

CRYSTAL CLOCK OSCILLATORS

■ WH1100D Series - High Speed CMOS DUAL OUTPUT - 250.00 kHz TO 200.000 MHz

Description: A crystal controlled, low current hybrid oscillator circuit with two independent frequency outputs in one package providing precise rise and fall times to drive high speed CMOS and NMOS microprocessors. Compatible with both high speed CMOS and TTL. Can drive up to 10 TTL loads. Input voltage at 3.3 VOC ±5% is available for battery/portable applications. Device is packaged in 14 pin Dip compatible case grounded to reduce RFI, contains an internal bypass supply capacitor which minimizes "cross-talk," resistance welded metal package.

SPECIFICATIONS

Frequency Range: 250KHz to 200.000MHz
 Frequency Stability: ±0.0010% to ±0.01% over all conditions: calibration tolerance, operating temperature, input voltage change, load change, aging, shock and vibration.

Temperature Range:
 Operating: 0°C to 70°C
 Storage: -55°C to + 125°C

Input Voltage: Rated Operating
 +5VDC ±10% +4VDC min +7VDCmax

Input Current: 250.000kHz to 3.4999MHz 10mA (Max)
 3.500MHz to 29.9999MHz 15mA (Max)
 30.000MHz to 69.9999MHz 30mA (Max)
 70.000MHz to 200.000MHz 80mA (Max)

HCMOS Output:
 Symmetry: 50% ± 5% at 50% VDD
 Rise & Fall Times: (10 TTL Loads):
 20% to 80% V_{DD}: T_r = 4 ns max, T_f = 4 ns max
 0.5 V to 2.5 V: T_r = 6ns max, T_f = 4 ns max
 "0" Level: V_{SS} + 0.5 V max.
 "1" Level: V_{DD} - 0.5 V min.

PACKAGES

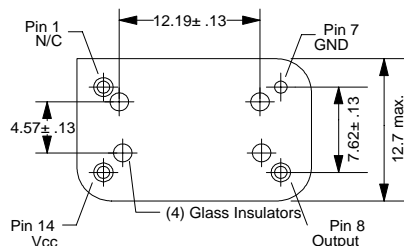
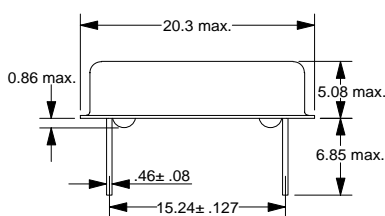

PIN	CONNECTION
1	Output F
7	GND
8	Output F
14	+V cc

TEST CIRCUIT DIAGRAM

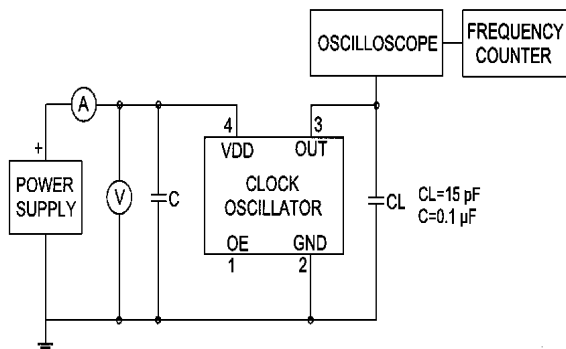

OUTPUT WAVEFORM

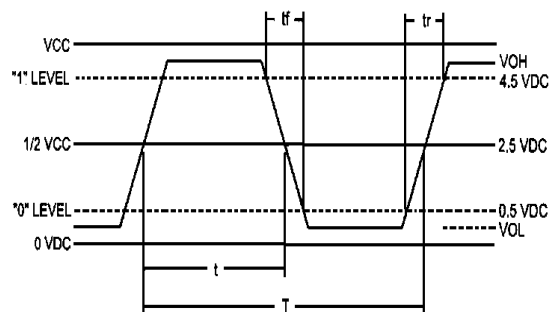

MECHANICAL/ENVIRONMENTAL

SHOCK: MIL-STD-202F, Method 213B, Cond. E, 1000 G's .35S, 1/2 Sine Wave
 VIBRATION: MIL-STD-202F, Method 204, 35G, 50 to 2000Hz
 HERMETICITY: Leak Rate < 2 x 10⁸ ATM, cc/Sec of helium,
 HUMIDITY: 85% relative humidity, 85°C, 48 hours
 STORAGE: -55° to 125°C

Part Numbering Guide: See Attached

Standard Marking Format

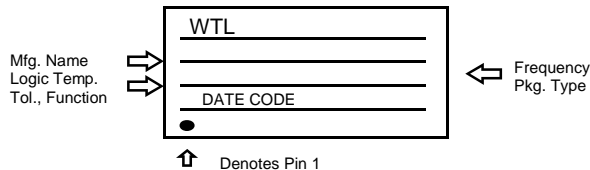



CRYSTAL CLOCK OSCILLATORS

Full Size Package — 14 PIN DIP

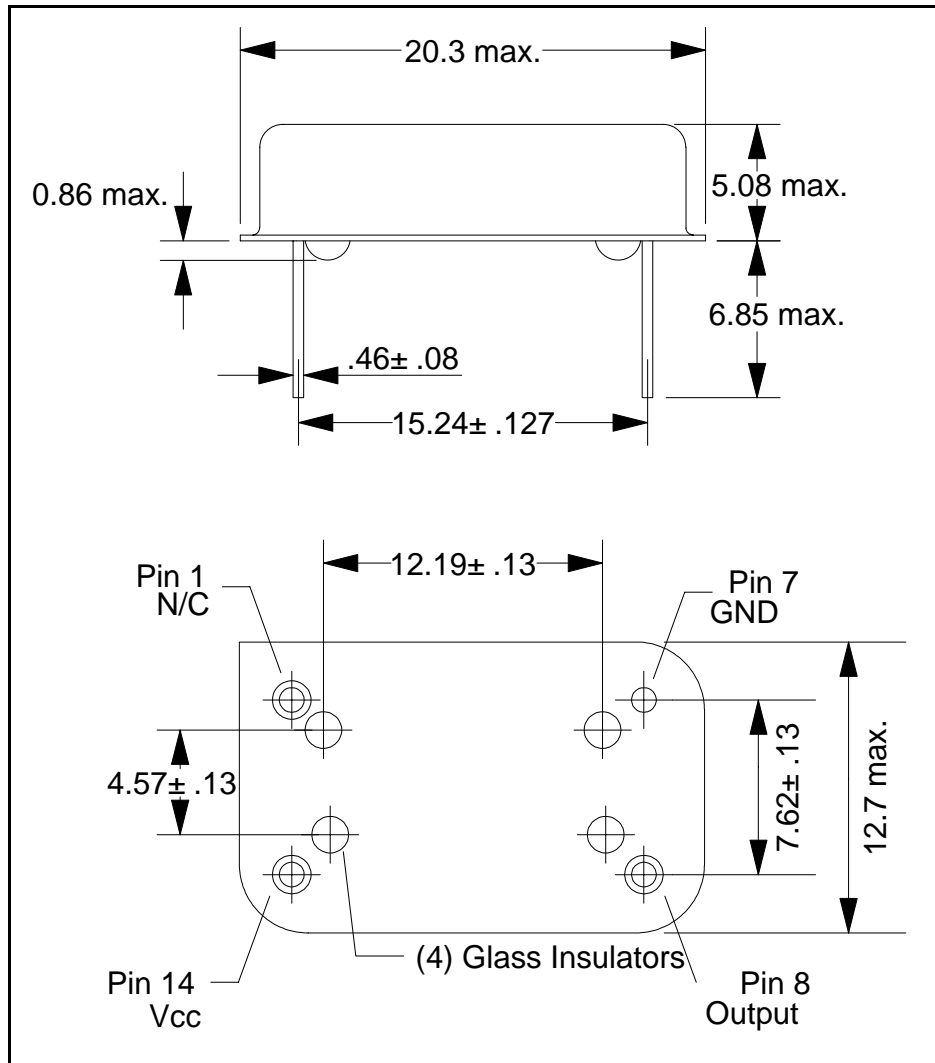

Enlarged View

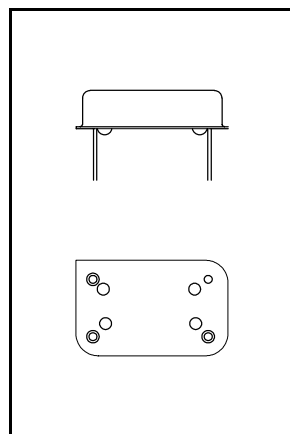

Actual Size Shown Above 1=1



PRECISION QUARTZ CRYSTAL CLOCK OSCILLATOR THRU HOLE/DIP SPECIFICATION RFQ FORM

Supply the Specifications and Fax WTL with your Information

NAME: _____ TITLE: _____ COMPANY: _____
 ADDRESS: _____ PHONE: _____ FAX NO: _____
 CITY: _____ STATE: _____ ZIP: _____ EMAIL: _____
 MAIL STOP: _____

Quantity Needed

IMMEDIATE: _____ DELIVERY REQUIRED: _____
 FUTURE NEEDS: _____ APPROX. DELIVERY DATE: _____
 CUSTOMER SPEC. DRAWING NO: _____ TARGET PRICE: _____ PER _____
 DEVICE TYPE & APPLICATION: _____
 PROJECT DESCRIPTION OR NO.: _____

How to Order Custom-Designed WTL Crystal Clock Oscillators

Please provide the following information concerning your crystal clock oscillator requirements

- 1. Output Frequency _____ MHz or KHz
- 2. Package Type _____
- 3. Frequency Stability _____ ppm
- 4. Operating Temperature Range _____ °C to _____ °C
- 5. Input Current _____ mA max.
- 6. Output Logic _____
- 7. Symmetry _____
- 8. Rise and Fall Times _____
- 9. Load _____ ns max.
- 10. Additional specifications, if any: _____

