

Specification for Speaker

Model No.	VS77210R8F350P1	Drawing No.	VS2022090303
Customer			

NO.	Items	Specification	Test Condition
1	Impedance	8Ω ±15%	at 1Vrms,0.8kHz
2	Resonant Fr. (fo)	350Hz±20%	
3	Frequency Range	F0-10KHz	
4	Rated Power	1W	
5	Max Power	2W	
6	S.P.L.	87dB±3dB	(0.1W/0.1M at0.8,1.0,1.2,1.5kHz Ave)
7	Distortion	<5% Max.	at 2kHz/2Vrms
8	Sweep Test	must be normal	at sine wave 4.7 V
9	Load Test	after test meet item 8	rated white noise power, 96 Hrs.
10	Heat Test	after test meet item 8	+60±2°C 20~50% 96Hrs.
11	Cold Test	after test meet item 8	-30±3°C 96Hrs.
12	Humidity Test	after test meet item 8	+40±2°C,90~95% 96Hrs.
13	Weight	80±5%g	
14	Polarity Test	with positive D.C. voltage to (+) terminal, the cone shall move forward.	
15	Note	IP60	

Frequency Response Curve

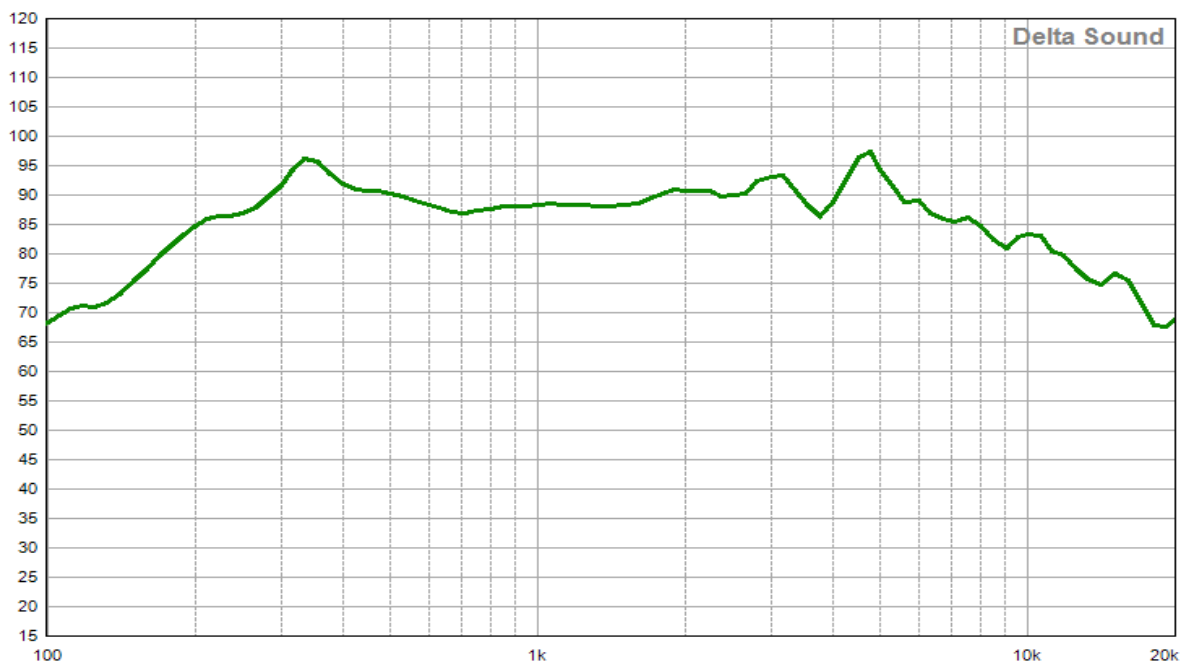

Specification for Speaker

Model No. VS77210R8F350P1

Drawing No.

VS2022090303

Dimensions:

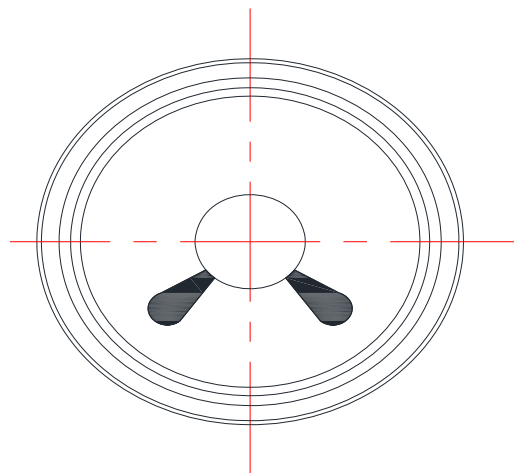
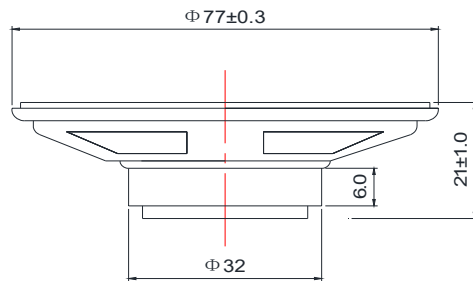
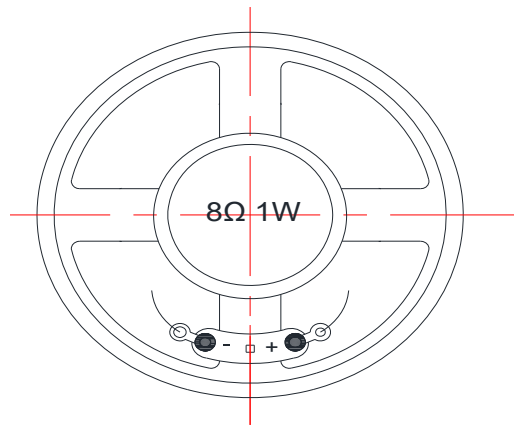

Unit : mm

Tolerance : ± 0.2