

Precision Devices, Inc.

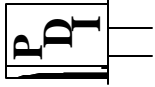

8840 N. Greenview Dr.
 Middleton, WI 53562
 Phone: 608-831-4445
 1-800-274-XTAL
 Fax: 608-831-3343

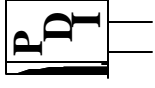

Visit our web site at www.pdixtal.com

Sales Information sales@pdixtal.com

Electrical Specifications

1. Center Frequency: 37.000000 MHz
2. Output: LVPECL
3. Frequency Tolerance: See Line 5
4. Operating Temperature Range: 0°C to +70°C
5. Frequency Stability: ±50ppm (Inclusive of tolerance, supply voltage change, reflow drift and 10 years aging)
6. Storage Temperature Range: -55°C to +125°C
7. Duty Cycle: 45/55% Maximum
8. Rise / Fall Times: 0.5nS Typical, 1nS Maximum
9. Supply Current: 60mA Typical, 90mA Maximum
10. Input Voltage: VIL: 0.3Vcc Maximum
 VIH: 0.7Vcc Minimum
11. Output Voltage: VOL: 1.68Vdc Maximum
 VOH: 2.275Vdc Maximum
12. Output Load: 50 Ohms Maximum
13. Start-up Time: 2mS Maximum
14. Supply Voltage: +3.3Vdc±5%
15. Period Jitter: 3pS Typical, 5pS Maximum (RMS)
16. Phase Jitter (12KHz to 20MHz): 0.5pS Typical, 1.0pS Maximum (RMS)
17. Enable Time: 2mS Maximum
18. Disable Time: 200nS Maximum
19. Standby Current: 30uA Maximum
20. Phase Noise: 10Hz Offset
 100Hz Offset -60dbc/Hz Typical
 1KHz Offset -90dbc/Hz Typical
 10KHz Offset -125dbc/Hz Typical
 100KHz Offset -140dbc/Hz Typical
 -145dbc/Hz Typical

The information contained in this drawing is the sole property of Precision Devices Inc. Any reproduction in part or as a whole without the written permission of Precision Devices Inc. is prohibited.

REV.	DATE	PAGE	DESCRIPTION	Auth.	ECN	Originator	Date	Engineering	Date
						J.L.	4/28/09	C.H.	4/28/09
						TITLE Crystal Oscillator Assembly		FKA	65025R
						PART NUMBER	PE0737000XMCARX		
						DATE	SCALE	ECN.	REV.
						4/28/09	N.T.S.		A
						SIZE	CAGE	Page 1 of 2	
						A	0S4G1		

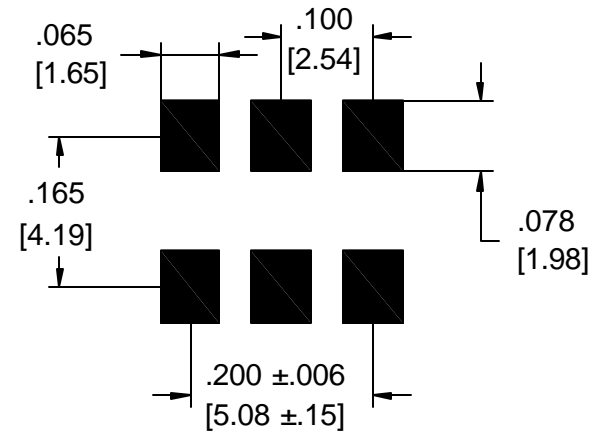
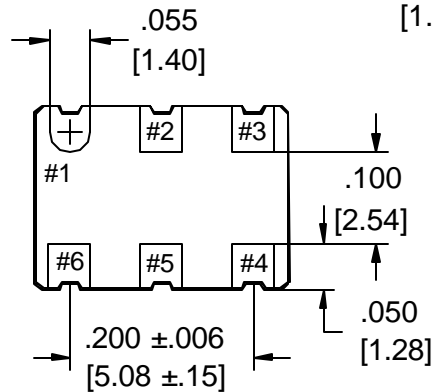
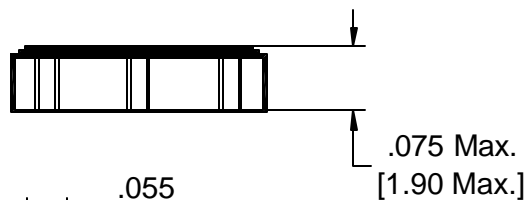
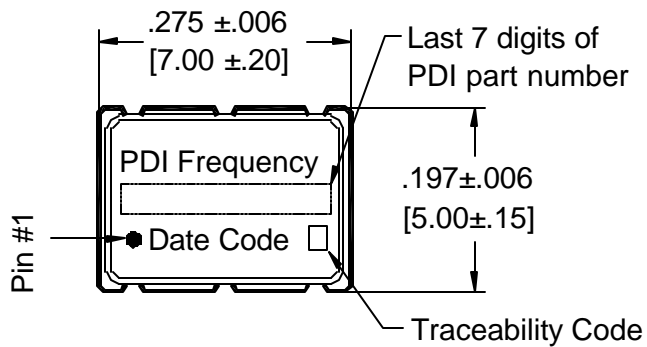

Recommended Land Pattern

PIN	CONNECTION
1	Output/Enable
2	No Connect
3	Ground
4	Output 1
5	Output 2
6	Vcc

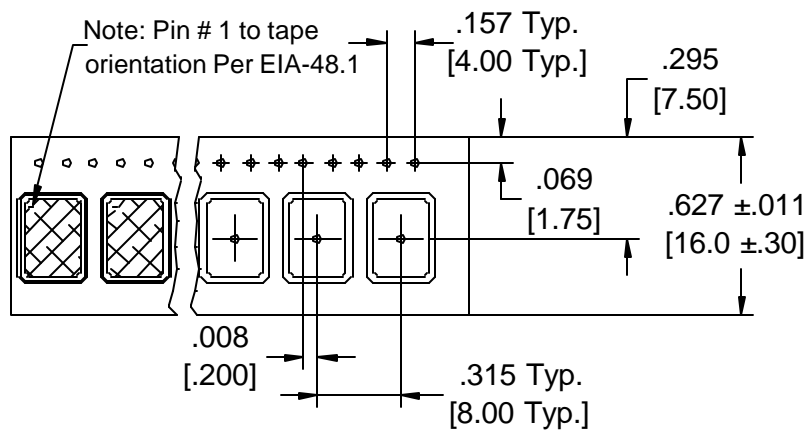

Precision Devices Inc.



8840 N. Greenview Dr.
Middleton WI 53562
608-831-4445
1-800-274-XTAL



Manufacturer of Quartz Crystal Products

DECIMAL XX=±.020 XXX=±.008	DWG FILE 65025R	PART NUMBER PE0737000XMCARX	
METRIC XX=±.50 XXX=±.20	SCALE N.T.S.	FREQUENCY 37.000000 MHz	DRAWN BY J.Lawinger
ANGULAR XX=±2°	DRAWING TYPE Crystal Oscillator Assembly	REV. LEVEL A	DATE 4/28/09
	ECN NO.	CAGE CODE 0S4G1	Page 2 of 2