

SPECIFICATION

客户 (Customer) : _____

产品名称 (Production Name) : _____

金涛峪产品型号 (FSJTY Part No.) _____

客户产品型号 (Customer Part No.) : _____

图纸编号(Drawing No.) _____ 规格书版本 (Version) : _____

Signature of Approval by Customer

--

Signature of FSJTY

Spec for Ultrasonic transducer	Drawing No.	Rev. No.
Model: JYYT100A28AD0H4-T0	UT-016	A0
Drawing	Approval	Sales Dept.

佛山金涛峪电子科技有限公司

Foshan Jintaoyu Electronics Technology Co., Ltd

1. Application

This ultrasonic cosmetic transducer is widely used in the ultrasonic beauty massager.

2. Part No.: JYYT100A28AD0H4-T0

3. Appearance and Dimension:

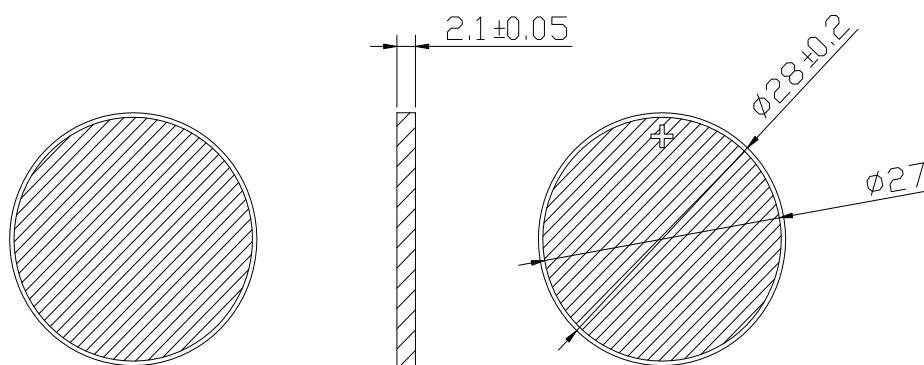

unit: mm

4. Electronic Performance:

No.	Item	Unit	Standard	Test Instruments
1	Resonant Frequency(Fr)	MHz	1.00±0.05	Agilent 4294A Impedance analyzer
2	Resonant Impedance(Zr)	Ω	≤3	
3	Electrostatic Capacitance (Cp)	pF	3800±20%	Digital Electronic Bridge (LCR Meter) (1KHZ/1V/25°C)
4	Dielectric Loss (tanδ)	/	≤0.5%	Digital Electronic Bridge (LCR Meter) (1KHZ/1V/25°C)
5	D33	/	≥280	D33 Meter

Test conditions: ultrasonic transducer shall be measured under a condition:
(Temp.:25°C±5°C, Humidity: 40%~70% R.H.).

5. Standard Package

Qty/Carton (pcs)	Carton Size (cm)	G.W. (Kg)	N.W. (kg)
2000	36.7×32.7×20.5	11.5	10.0

6 . Notes

1. The ultrasonic transducer should be packed completely in the closed environment, there is no acidic, alkaline, or other corrosive gases around it, no strong mechanical vibration or magnetic field in the warehouse.
2. Because strong impact stress on the transducer leads to damage the appearance and damage the electronic performance of it , so please take it with care to prevent strong impact stress on it..
3. The ultrasonic transducer should be taken by hand with the clean gloves or fingerstall to prevent the oil or sweat to contaminate the electrode surface of it.
4. The main material of the ultrasonic transducer is lead zirconate-titanate ceramics, so please abide by the local Environmental laws and regulations when discarding.

版本记录 (Revision History)

Revision No.	Date	Page	Description
A0	2016-12-16	/	New Spec
A1	2017-05-10	/	Spec Format Updated