

规格书编号

SPEC NO:

产品规格书

SPECIFICATION

CUSTOMER 客户: _____
PRODUCT 产品: _____ SAW FILTER _____
MODEL NO 型号: _____ HDF845A3-S6 _____
MARKING 印字: _____ HDF6899 _____
PREPARED 编制: _____ CHECKED 审核: _____
APPROVED 批准: _____ D A T E 日期: _____ 2012-12-3 _____

客户确认 CUSTOMER RECEIVED:		
审核 CHECKED	批准 APPROVED	日期 DATE

无锡市好达电子有限公司
Shoulder Electronics Limited

1. Package Dimension

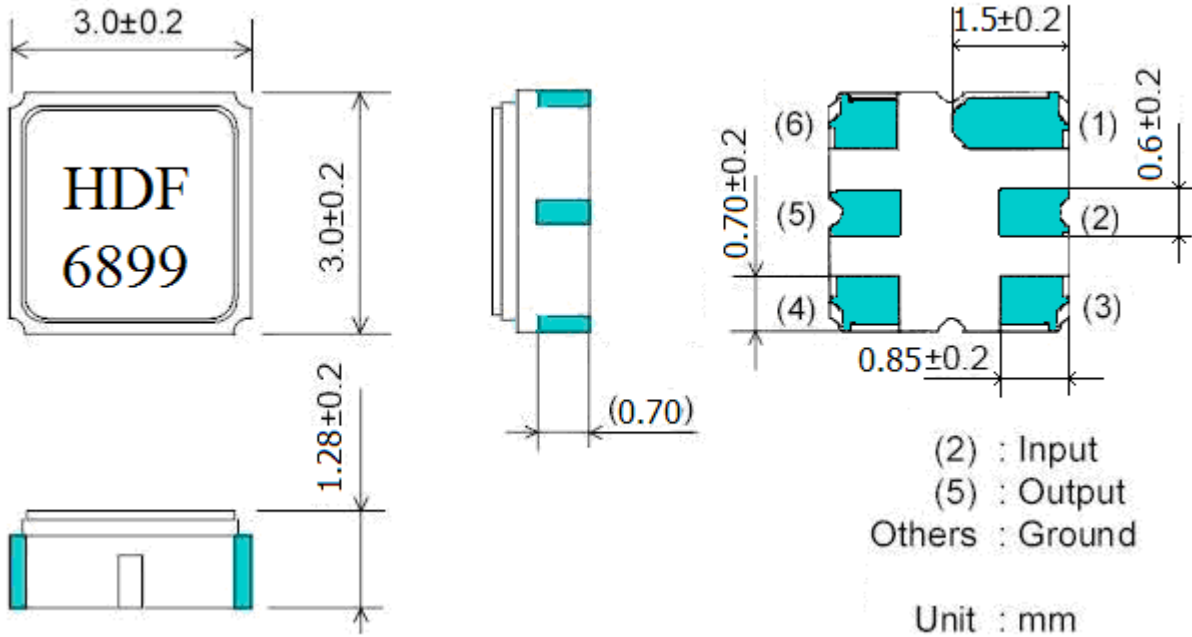

2. Performance

2.1 Maximum Rating

DC Voltage VDC	10V
AC Voltage Vpp	10V50Hz/60Hz
Operation temperature	-45°C to +85°C
Storage temperature	-45°C to +85°C
RF Power Level	10dBm

2.2 Electronic Characteristics

	Unit	Minimum	Typical	Maximum
Center Frequency	MHz	-	845	-
Insertion Loss (840~850MHz)	dB		2.0	3.5
Amplitude Ripple(840~850MHz)	dB		0.5	1.5
VSWR(840~850MHz)			1.5	-
Relative Attenuation				
0~810 MHz	dB	40	55	-
880~1300MHz		40	55	
Input/Output Impedance	Ohms		50	

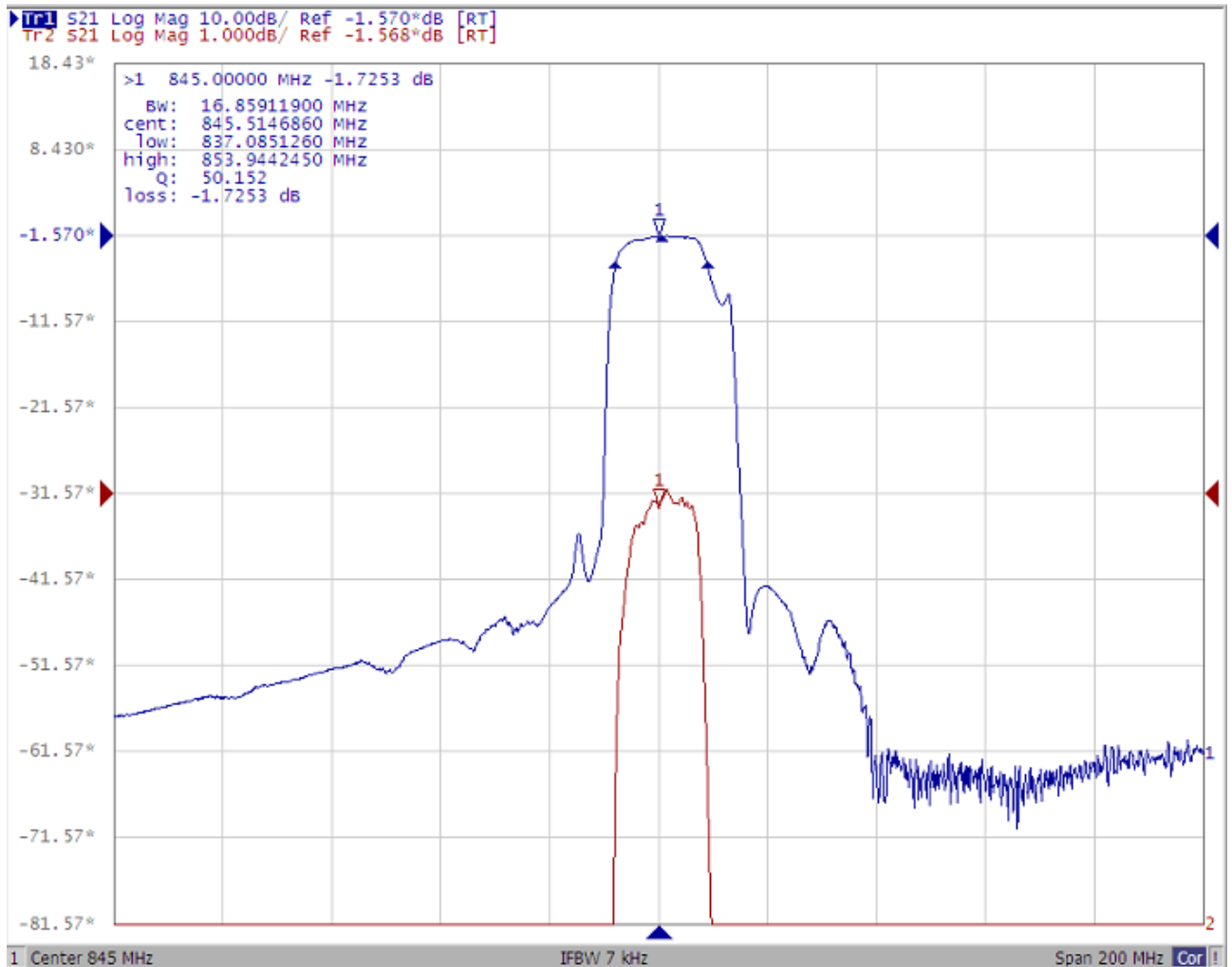

3. TEST CIRCUIT

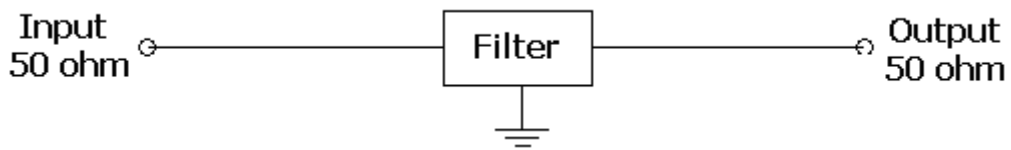

4. ENVIRONMENTAL CHARACTERISTICS

4-1 Temperature cycling

Subject the device to a low temperature of -45°C for 30 minutes. Following by a high temperature of $+25^{\circ}\text{C}$ for 5 Minutes and a higher temperature of $+85^{\circ}\text{C}$ for 30 Minutes. Then release the device into the room conditions for 1 to 2 hours prior to the measurement. It shall meet the specifications in 3.3.

4-2 Resistance to solder heat

Submerge the device terminals into the solder bath at $260^{\circ}\text{C} \pm 5^{\circ}\text{C}$ for 10 ± 1 sec. Then release the device into the room conditions for 4 hours. It shall meet the specifications in 3.3.

4-3 Solderability

Submerge the device terminals into the solder bath at $245^{\circ}\text{C} \pm 5^{\circ}\text{C}$ for 5s, More than 95% area of the soldering pad must be covered with new solder. It shall meet the specifications in 3.3.

4-4 Mechanical shock

Drop the device randomly onto the concrete floor from the height of 1 m 3 times. the filter shall fulfill the specifications in 3.3.

4-5 Vibration

Subject the device to the vibration for 2 hour each in x,y and z axes with the amplitude of 1.5 mm at 10 to 55 hz. The filter shall fulfill the specifications in 3.3.

5. REMARK

5.1 Static voltage

Static voltage between signal load & ground may cause deterioration & destruction of the component. Please avoid static voltage.

5.2 Ultrasonic cleaning

Ultrasonic vibration may cause deterioration & destruction of the component. Please avoid ultrasonic cleaning

5.3 Soldering

Only leads of component may be soldered. Please avoid soldering another part of component.

6. Packing

6.1 Dimensions

(1) Carrier Tape: Figure 1

(2) Reel: Figure 2

(3) The product shall be packed properly not to be damaged during transportation and storage.

6.2 Reeling Quantity

1000 pcs/reel 7"

3000 pcs/reel 13"

6.3 Taping Structure

(1) The tape shall be wound around the reel in the direction shown below.

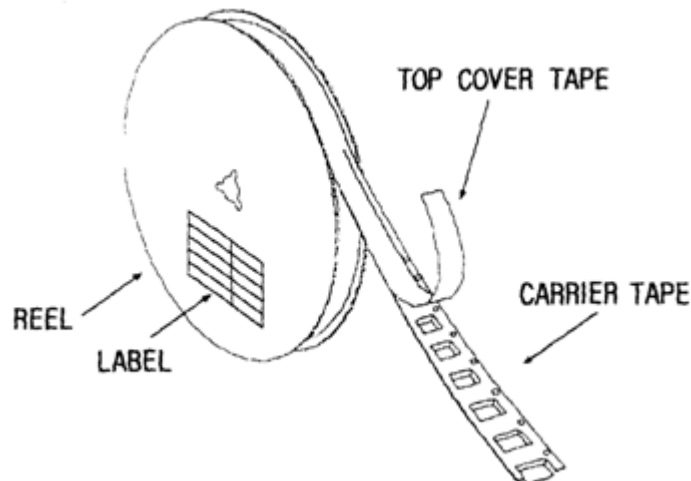

(2) Label

Device Name	
User Product Name	
Quantity	
Lot No.	

(3) Leader part and vacant position specifications.

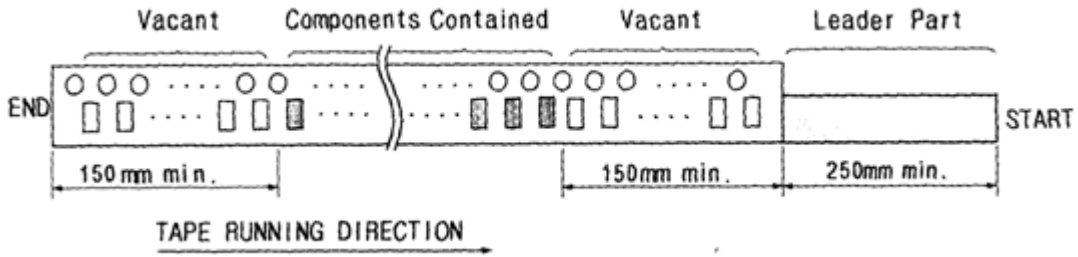

7. TAPE SPECIFICATIONS

7.1 Tensile Strength of Carrier Tape: 4.4N/mm width

7.2 Top Cover Tape Adhesion (See the below figure)

- (1) pull off angle: 0~15°
- (2) speed: 300mm/min.
- (3) force: 20~70g

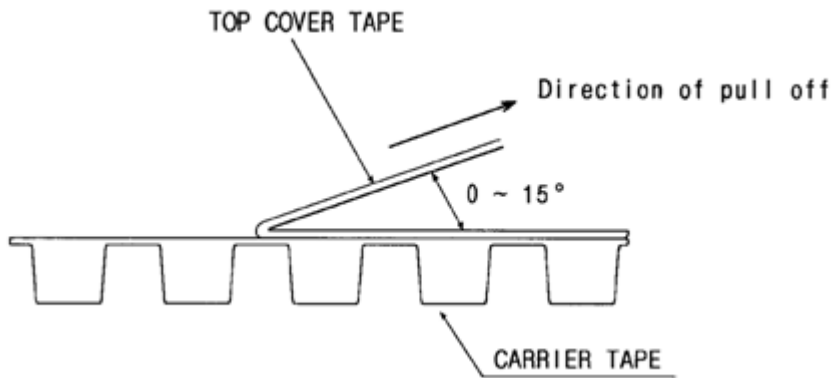

[Figure 1] Carrier Tape Dimensions

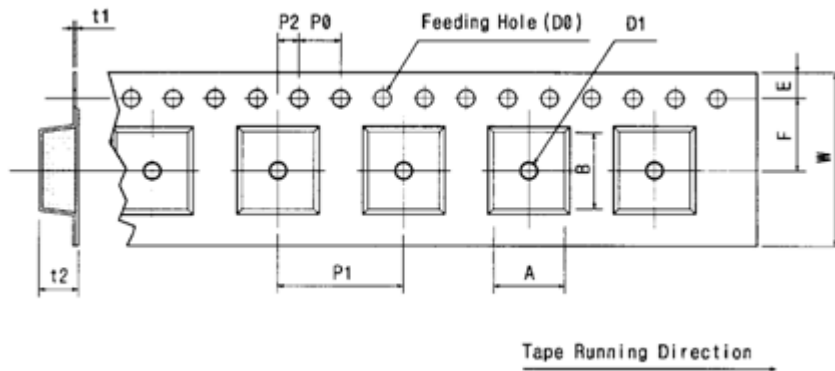

[Unit:mm]

W	F	E	P0	P1	P2	D0	D1	t1	t2	A	B
12.00	5.50	1.75	4.00	8.00	2.00	Ø1.50	Ø1.0	0.25	1.65	4.04	4.10
±0.30	±0.10	±0.10	±0.10	±0.10	±0.10		±0.25	±0.05	±0.10	±0.10	±0.10

[Figure 2]

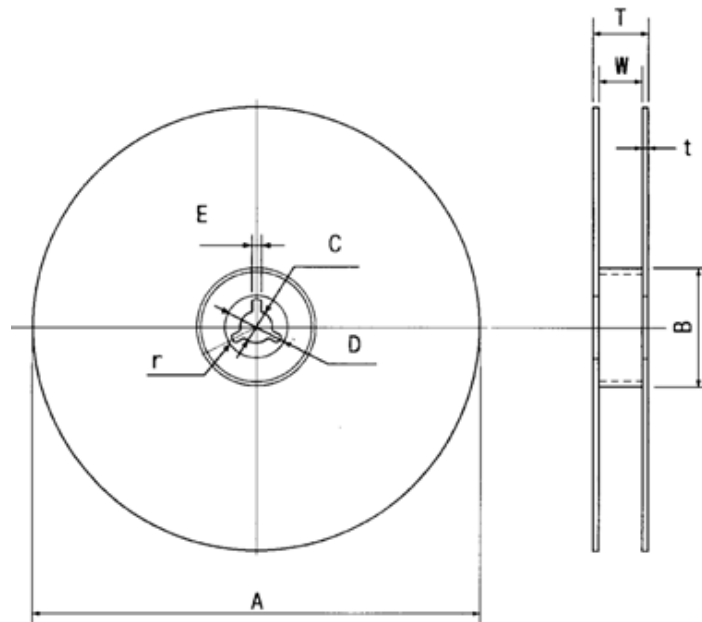

[Unit:mm]

A	B	C	D	E	W	t	r
Ø330	Ø100	Ø13	Ø21	2	13	3	1.0
±1.0	±0.5	±0.5	±0.8	±0.5	±0.3	max.	max.