

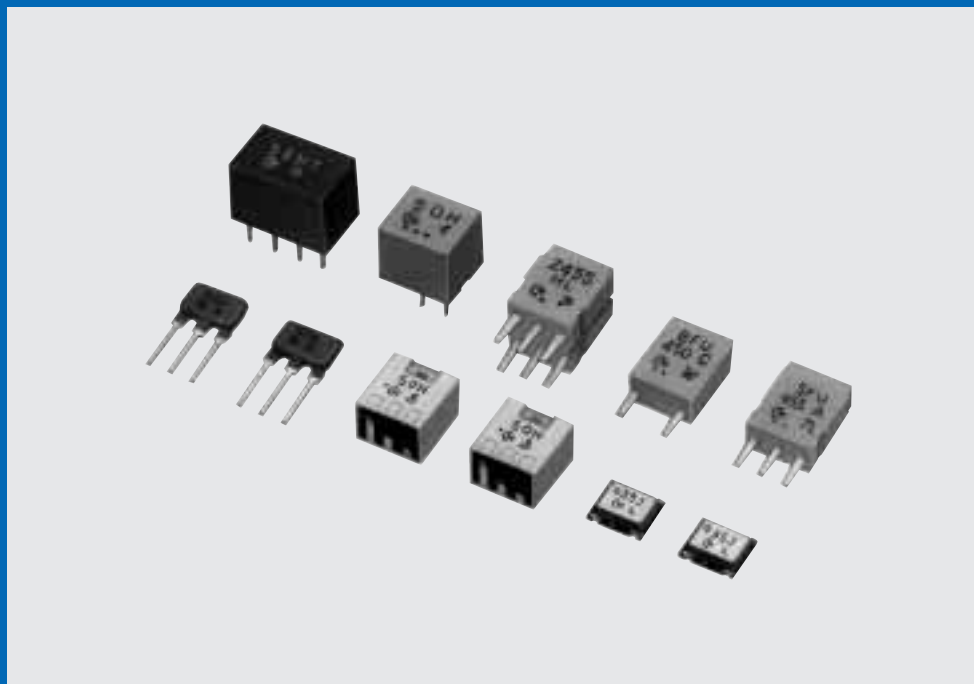

# CERAMIC FILTER (CERAFIL®) For AM Receivers

**SF□/PF□/BF□ Series**

## CERAMIC FILTER (CERAFIL®)



*Innovator  
in Electronics*

Murata  
Manufacturing Co., Ltd.

**■CONTENTS**

■SFU/SFZ Series 450 - 470kHz ..... 1 - 2

■High Selectivity Ladder Type  
 SFPS/CFWS Series 450 - 470kHz ..... 3 - 4

■Wide band Type for AM Stereo  
 SF□/CF□450 Series ..... 5 - 6

■Ultra-small PF□ Series 450 - 470kHz ..... 7 - 8

■High Selectivity SMD Ladder Type  
 SFPC Series ..... 9

■Two terminals Resonance Type Series  
 450 - 470kHz ..... 10

■SF□/PF□/BF□Series Temperature ..... 11

■SF□/PF□/BF□Series Application ..... 12

■SF□/PF□/BF□Series Application/Notice ..... 13

**INTRODUCTION**

Worldwide, AM is used more than any other broadcasting form. There are three versions of this broadcasting ... long waves (LW), medium waves (MW), and short waves (SW).

Broadcasting stations send signals at intervals of 9 kHz for LW, 9 or 10 kHz for MW, and 5 kHz for SW. Radio waves travel long distances before they reach receivers ; thus, the primary requirement for receivers is to have high selectivity. This is possible only with the help of the high grade intermediate frequency filter. Murata's CERAFIL® for AM use is one of the most recommendable IF filters, having such distinctive features as : high selectivity, high stability and adjustment-free operation.

Additionally its easy matching with IC helps create an easy circuit design. We have long enjoyed a reputation as one of the best AM receiver component suppliers around the world. On the other hand, technology of AM receiver has been outstandingly improved as follows.

- Electric synthesized tuners
- Hi-Fi audio systems
- AM stereo demodulations
- One-chip non-adjustment IC's
- Even smaller, thinner set structure

To cope with these diversifying AM receiver, Murata's CERAFILS® for AM use are available for every type of AM receiver.

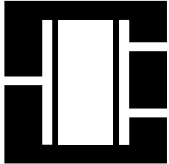

# CERAMIC FILTER

CERAFIL® is the Registered Trademark of Murata Manufacturing Co., Ltd.



## SFU/SFZ Series 450 - 470kHz

### SPECIFICATION

Part Number	3dB Band Width (kHz)	Selectivity		Insertion Loss (dB) max.	Composition
		+9kHz off (dB) min.	-9kHz off (dB) min.		
SFU455A	10±3	3 (5.5)	5 (7.5)	5 (3)	1 Element for contact to resistor
SFU455C5	5±1.5	7 (10)	10 (13.5)	6 (3.8)	1 Element for contact to resistor
SFU455B	10±3	3 (5.5)	5 (7.5)	5 (3)	1 Element for contact to IFT
SFZ455HL	4±1	23 (28)		7 (4.5)	2 Elements
SFZ455JL	5.5±1	18 (22)		7 (3.5)	2 Elements
SFZ455KL	7±1	16 (20)		6 (2.7)	2 Elements

( ): Typ. value

- Center frequency range between 450 and 470 kHz are available. Standard tolerance is ±2 kHz.
- For synthesizers, the types of center frequencies 450, 459 and 468 kHz are available. Standard tolerance is ±1 kHz.
- The part numbers of the types for synthesizers are as follows. (In case of 450kHz)

SFU450A3 (for contact to resistor)

SFU450C5 (for contact to resistor)

SFU450B14 (for contact to IFT)

SFZ450HL3/JL3/KL3 (for contact to IFT)

### FREQUENCY CHARACTERISTICS

Part Number	6dB Band Width (kHz) min.	Selectivity		Input Level (at 0.6m output) (dB)
		+9kHz off (dB)	-9kHz off (dB)	
IFT+SFU455B	6.5	20	23	78
IFT+SFZ455HL	5.0	38		78
IFT+SFZ455JL	7.0	33		78
IFT+SFZ455KL	8.5	27		78

( ): Typ. value

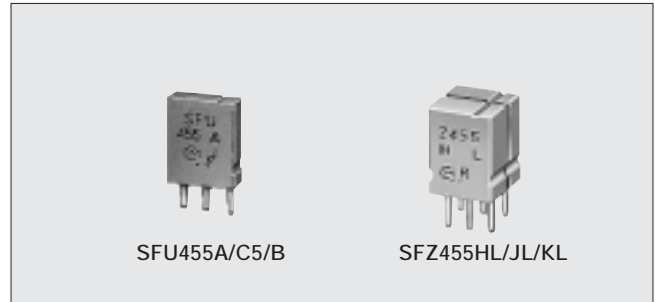

### DIMENSIONS

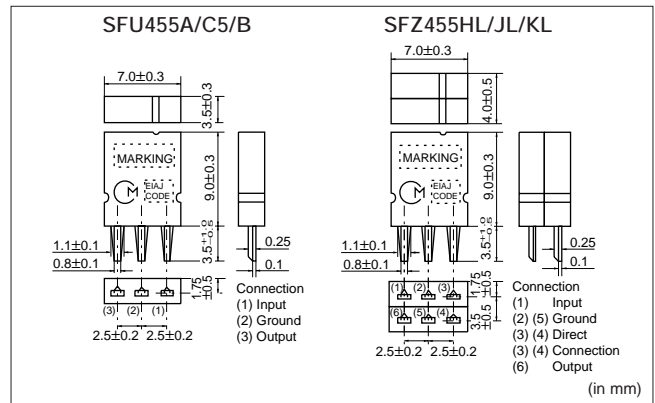

### THE RECOMMENDED IFT (7×7)

Item	Type	SFU□B			SFZ□HL/JL/KL		
		(1) - (2)	(2) - (3)	(4) - (6)	(1) - (2)	(2) - (3)	(4) - (6)
Winding specifications							
S(3) (2) (1)	(4)S (6)	70T	115T	7T	68T	84T	14T
(Bottom view)							
No-load Qu		105			90		
Tuning Capacitance		180pF			180pF		

- Matching of CERAFIL® SFU/SFZ series with IFT is decided by the IFT secondary side impedance,  $|Z_2|$ . The design target values of  $|Z_2|$  are :  
 For SFU□B : 300Ω  
 For SFZ□HL/JL/KL : 1kΩ

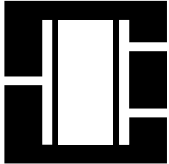

# CERAMIC FILTER

CERAFIL® is the Registered Trademark of Murata Manufacturing Co., Ltd.



## SFU/SFZ Series 450 - 470kHz

### TEST CIRCUIT

#### ● Ceramic Filter Only

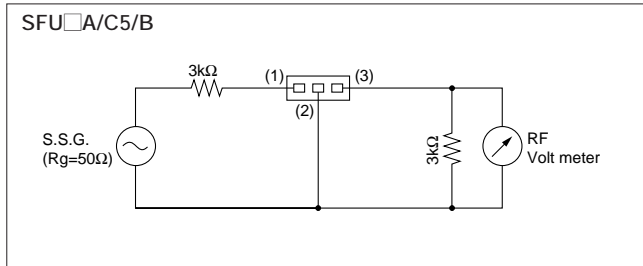

#### ● CERAFIL® with IFT

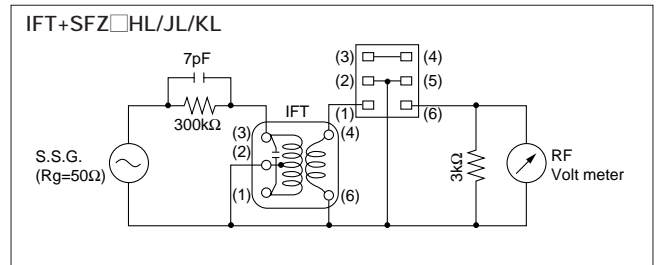
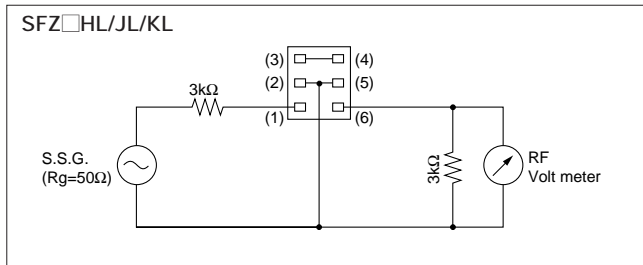
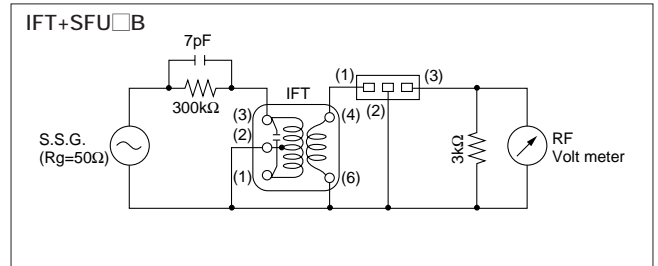

### FREQUENCY CHARACTERISTICS (with IFT)

#### ● Frequency Characteristics

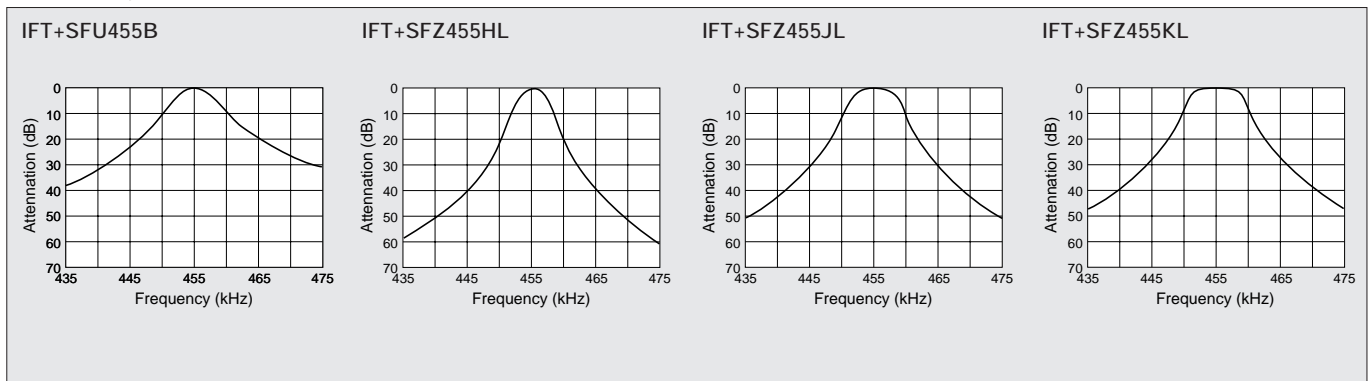

#### ● Spurious Characteristics

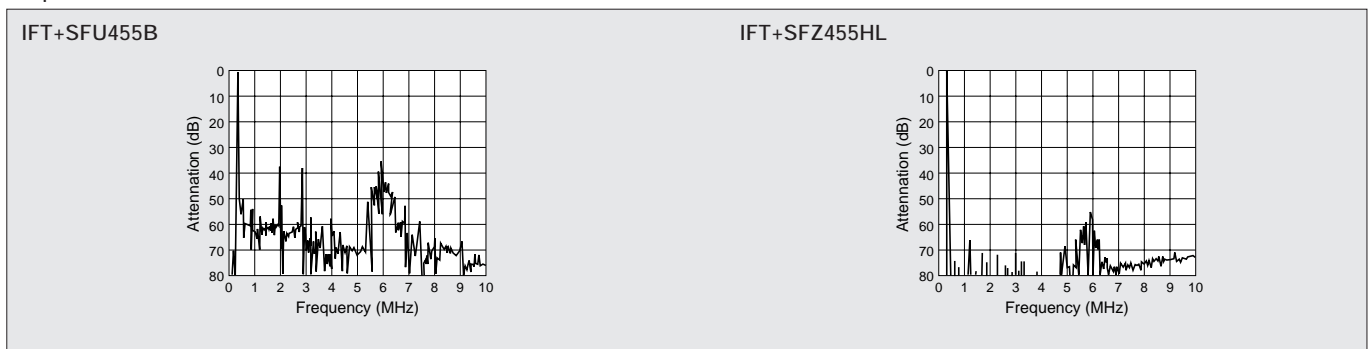

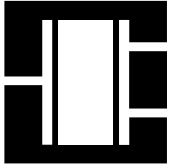

# CERAMIC FILTER

CERAFIL® is the Registered Trademark of Murata Manufacturing Co., Ltd.



## High Selectivity Ladder Type **SFPS/CFWS** Series 450 - 470kHz

### ■ SPECIFICATION

Part Number	6dB Band Width (kHz) min.	Selectivity ±9kHz off (dB) min.	Insertion Loss (dB) max.	Matching Impedance (kΩ)	Composition
SFPS450H	±3.0 (±4.0)	40 (60)	6 (1.5)	2.0	4 Elements Ladder Type
CFWS450HT	±3.0 (±4.0)	50 (75)	6 (2.0)	2.0	6 Elements Ladder Type

( ) : Typ. value

- For synthesizers, the available center frequencies are 450, 459 and 468 kHz. Standard tolerance is ±1 kHz.
- Because of excellent shape factor, wide-band width and high selectivity, this series is the most suitable to car radios and all-band radios.
- SFPS 450I, designed for narrow band use, are also available. Please contact us for further information.

### ■ THE RECOMMENDED IFT (7×7mm)

Item	Type	SFPS/CFWS□H		
Winding specifications		(1) - (2)	(2) - (3)	(4) - (6)
S(3) (2) (1)		60T	125T	28T
(Bottom view)				
No-load Qu		40		
Tuning Capacitance		180pF		

- Matching of CERAFIL® SFPS/CFWS□H with the IFT is decided by the Qu of the IFT and the IFT secondary side impedance, |Z<sub>2</sub>|. Set the Qu at about 40 because a Qu value which is too high (e.g., 90) may produce ripple in the waveform. It is recommended to match the impedance of |Z<sub>2</sub>| with that of the CERAFIL®.

### ■ TEST CIRCUIT

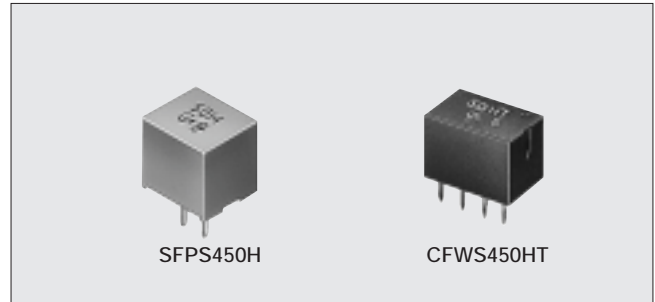
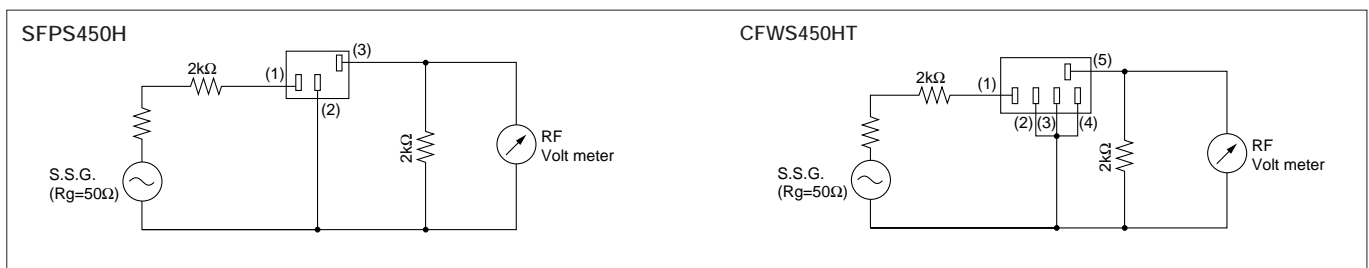

### ■ DIMENSIONS

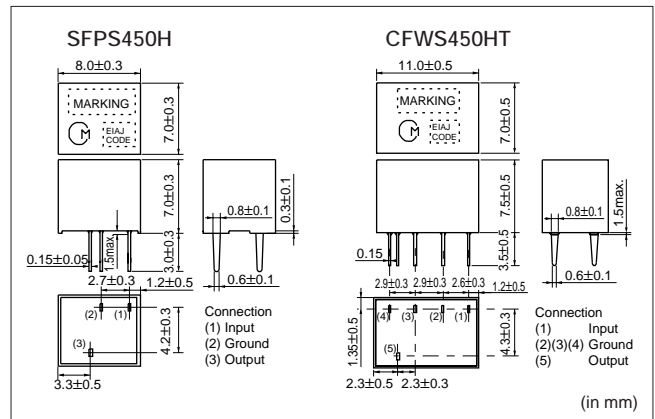

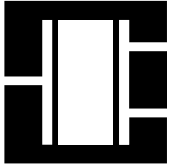

# CERAMIC FILTER

CERAFIL® is the Registered Trademark of Murata Manufacturing Co., Ltd.



## High Selectivity Ladder Type **SFPS/CFWS** Series 450 - 470kHz

### ■ FREQUENCY CHARACTERISTICS (with IFT)

#### ● Frequency Characteristics

IFT+SFPS450H

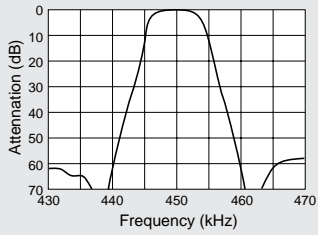

IFT+CFWS450HT

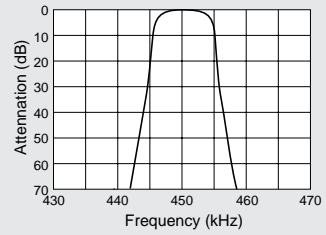

#### ● Spurious Characteristics

IFT+SFPS450H

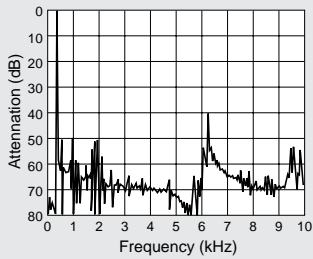

IFT+CFWS450HT

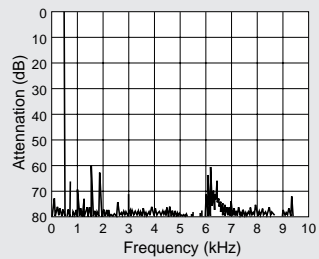

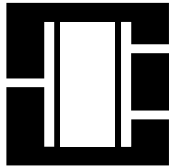

# CERAMIC FILTER

CERAFIL® is the Registered Trademark of Murata Manufacturing Co., Ltd.



## Wide band Type for AM Stereo SF□/CF□ 450 Series

### FEATURES

SFPS/CFWS Series :

wide band, high selectivity, low loss.

CFUS-Y/CFWS-Y Series :

wide band, flat group delay time (GDT) characteristics. (The frequency fidelity in the high sound area of an AM stereo will be improved.)

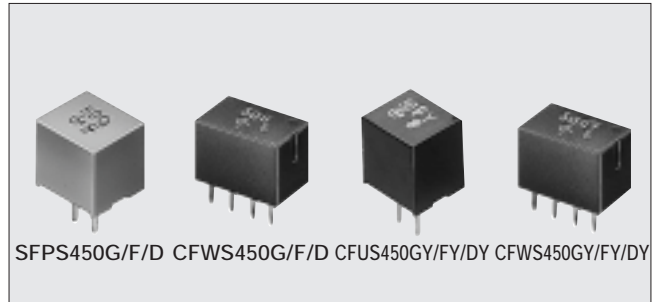

SFPS450G/F/D CFWS450G/F/D CFUS450GY/FY/DY CFWS450GY/FY/DY

### DIMENSIONS

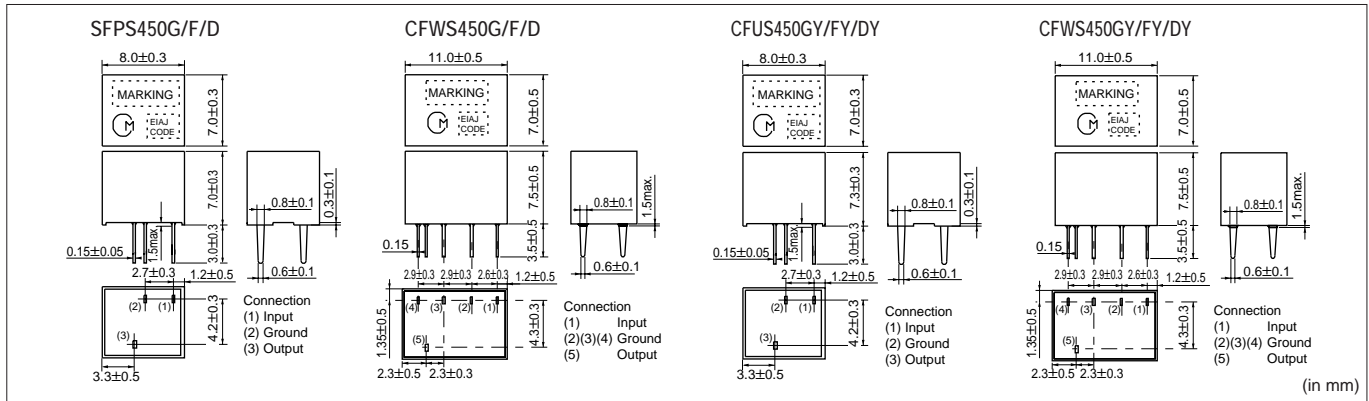

### SPECIFICATION

Part Number	6dB Band Width (kHz) min.	Selectivity (dB) min.	Insertion Loss (dB) max.	G. D. T. 20μ Band width (kHz)	Matching Impedance (kΩ)	Composition
SFPS450G	±4.5 (±5.0)	±9kHz off 30 (40)	6 (2)	—	2	4 Elements ladder type
SFPS450F	±6 (±7.5)	±12.5kHz off 40 (50)	6 (1.5)	—	2	4 Elements ladder type
SFPS450D	±10 (±12)	±20kHz off 40 (50)	4 (1.5)	—	1.5	4 Elements ladder type
CFWS450G	±4.5 (±5.5)	±9kHz off 40 (55)	6 (2.5)	—	2	6 Elements ladder type
CFWS450F	±6 (±7.5)	±12.5kHz off 50 (70)	6 (2)	—	2	6 Elements ladder type
CFWS450D	±10 (±12)	±20kHz off 50 (70)	6 (2)	—	1.5	6 Elements ladder type
CFUS450GY	±4.5 (±5.5)	±15kHz off 40 (50)	10 (7)	(±4.5)	2	4 Elements ladder type
CFUS450FY	±6 (±7.5)	±17.5kHz off 40 (50)	9 (5.5)	(±6)	2	4 Elements ladder type
CFUS450DY	±10 (±12)	±25kHz off 40 (50)	7 (4)	(±9)	1.5	4 Elements ladder type
CFWS450GY	±4.5 (±5.5)	±15kHz off 50 (70)	11 (8)	(±4)	2	6 Elements ladder type
CFWS450FY	±6 (±7.5)	±17.5kHz off 50 (70)	10 (6.5)	(±5)	2	6 Elements ladder type
CFWS450DY	±10 (±12)	±25kHz off 50 (70)	8 (5)	(±8)	1.5	6 Elements ladder type

( ) : Typ. value

- The standard center frequency (f<sub>0</sub>) tolerance is ±1 kHz.
- The recommended IFT specifications are the same as those for the SFPS 450 H/CFWS 450 HT. Set the Q<sub>u</sub> at approximately 40. If Q<sub>u</sub> is too high, ripple will be produced in the waveform, which will narrow the band width.
- Products with other band widths are also available :



# CERAMIC FILTER

CERAFIL® is the Registered Trademark of Murata Manufacturing Co., Ltd.



## Wide band Type for AM Stereo SF□/CF□ 450 Series

### ■ FREQUENCY CHARACTERISTICS (with IFT)

IFT+SFPS450F

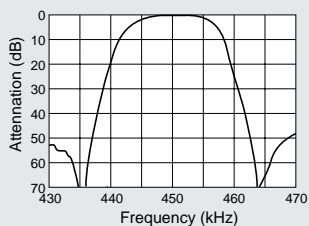

IFT+CFWS450F

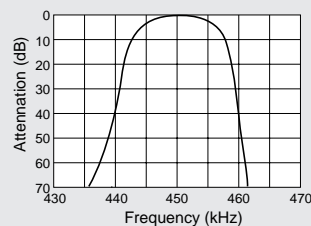

IFT+CFUS450FY

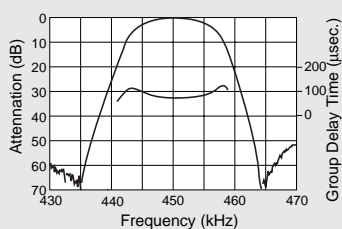

IFT+CFWS450FY

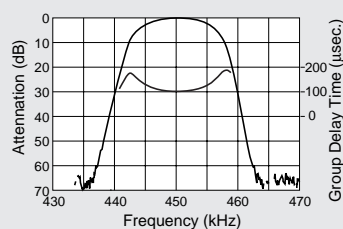



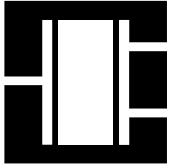

# CERAMIC FILTER

CERAFIL® is the Registered Trademark of Murata Manufacturing Co., Ltd.



## Ultra-small PF□ Series 450 - 470kHz

### ■ SPECIFICATION

Part Number	3dB Band Width (kHz)	Selectivity ±9kHz off (dB) min.	Insertion Loss (dB) max.	Composition
PFS455A	4.5±1.5	8 (11)	5 (2.5)	1 Element
PFW455J	5.5±1.5	17 (23)	6 (3)	2 Element
PFWCC450J	5.5±1.5	17 (23)	6 (3)	2 Elements SMD

( ) : Typ. value

- Center frequency is available between 450 and 470 kHz . Standard tolerance is ±2kHz.
- For synthesizers, the types of center frequencies 450, 459 and 468 kHz are available. Standard tolerance is ±1 kHz.
- PFS/PFW series available on tape. ("-TF01" is added to the part number for tape. ex. PFS455A-TF01)
- PFWCC series is mountable by automatic placers. ("-TC" is added to the part number for tape reel. ex. PFWCC450J-TC)

### ■ THE RECOMMENDED IFT

Item	Type	7×7mm IFT			5×5mm IFT		
		(1) - (2)	(2) - (3)	(4) - (6)	(1) - (2)	(2) - (3)	(4) - (6)
Winding specifications							
S(3) (2) (1)	(4)S (6)	85T	67T	23T	84T	98T	33T
(Bottom view)							
No-load Qu		90			65		
Tuning Capacitance		180pF			180pF		

- The matching of CERAFIL® PF□ series with the IFT is determined by the IFT secondary side impedance, |Z<sub>2</sub>|. Set the |Z<sub>2</sub>| at about 4.2kΩ.

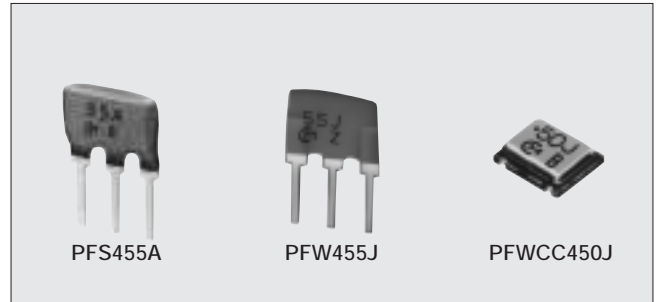

### ■ DIMENSIONS

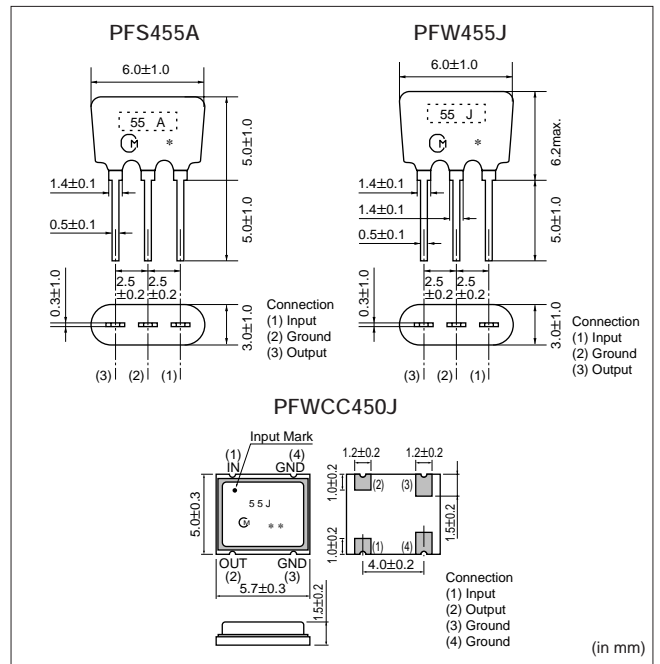

### ■ TEST CIRCUIT

#### ● Ceramic Filter Only

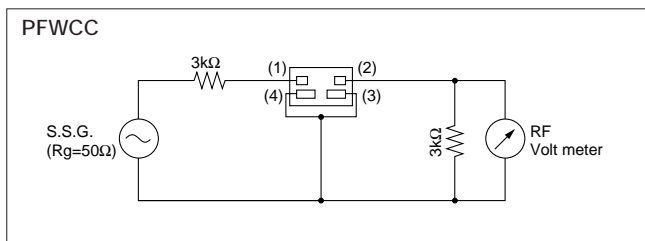
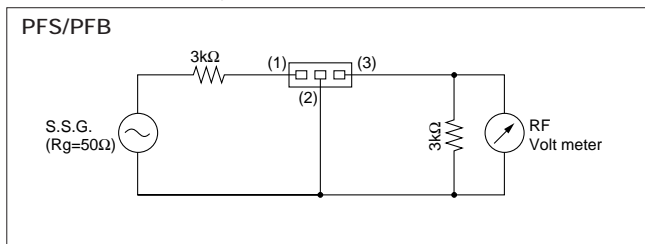

#### ● CERAFIL® with IFT

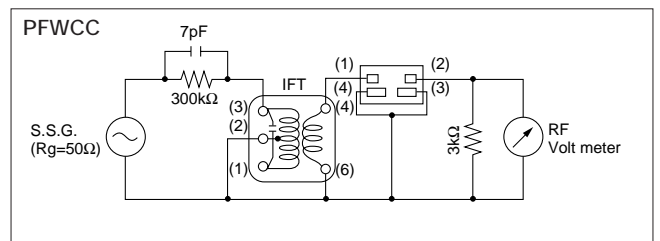
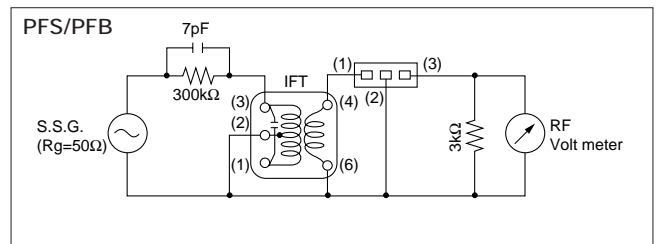

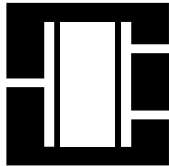

# CERAMIC FILTER

CERAFIL® is the Registered Trademark of Murata Manufacturing Co., Ltd.



## Ultra-small PF□ Series 450 - 470kHz

### ■ FREQUENCY CHARACTERISTICS

#### ● Frequency Characteristics

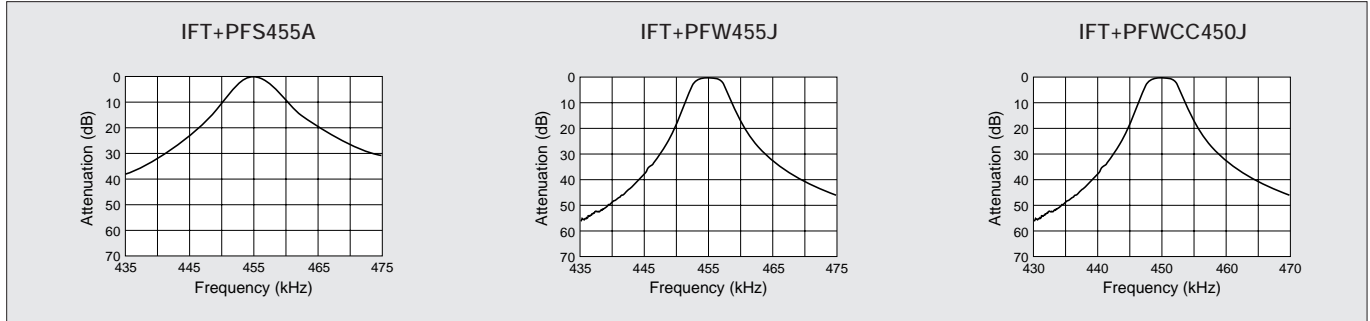

#### ● Spurious Characteristics

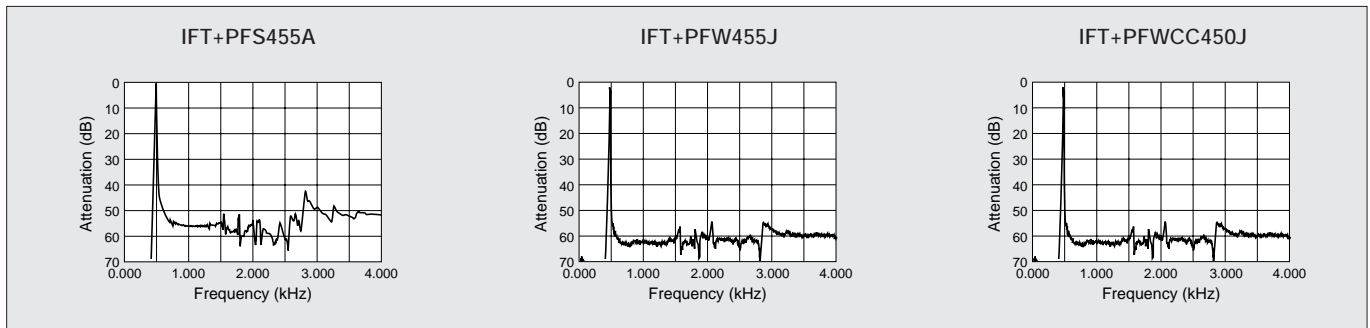

### ■ TAPING DIMENSIONS

**PFS/PF□-TF01**

Item	Code	Dimensions (mm)	Note
Portion to Cut Case of Defect	L <sub>1</sub>	3 min.	
Pitch of Component	P	12.7±0.5	
Pitch of Sprocket Hole	P <sub>0</sub>	12.7±0.2	
Length from Hole Center to Lead	P <sub>1</sub>	3.85±0.5	
Length from Hole Center to Component Center	P <sub>2</sub>	6.35±0.5	
Lead Spacing (1)	F	5.0 <sup>+0.5</sup> / <sub>-0.5</sub>	
Lead Spacing (2)	F <sub>1</sub>	2.5±0.2	
Deviation across Tape	Δh	0±1.0	
Deviation along Tape, Left or Right	ΔS <sub>1</sub>	0±1.0	
Carrier Tape Width	W	18.0±0.5	
Hold-down Tape Width	W <sub>0</sub>	6.0 min.	Hold-down tape should not overflow the base tape.
Position of Sprocket Hole	W <sub>1</sub>	9.0±0.5	
Hold-down Tape Width	W <sub>2</sub>	0 <sup>+0.5</sup> / <sub>-0.5</sub>	
Lead Distance between Reference and Bottom Planes	H <sub>0</sub>	18.0±0.5	
Diameter of Sprocket Hole	D <sub>0</sub>	φ4.0±0.2	
Total Tape Thickness	t	0.6±0.5	

**PFWCC□-TC**

- Part Number marked side is always facing upside.
- The direction of electrode shall be placed by one direction.

(in mm)



# CERAMIC FILTER

CERAFIL® is the Registered Trademark of Murata Manufacturing Co., Ltd.



## High Selectivity SMD Ladder Type **SFPC** Series

### ■ SPECIFICATION

Part Number	6dB Band Width (kHz) min.	Selectivity ±9kHz off (dB) max.	Insertion Loss (dB) min.	Matching Impedance (kΩ)	Composition
SFPC450H	±3.0 (4.0)	40 (60)	6 (1.5)	2.0	4 Elements, SMD

- Mountable by automatic placers.  
("TC" is added to the part number for tape and reel. ex. SFPC 450 H-TC)
- SFPC 450F/SFPC450G, designed for wide band use, are also available. Please contact us for further information.



### ■ TEST CIRCUIT

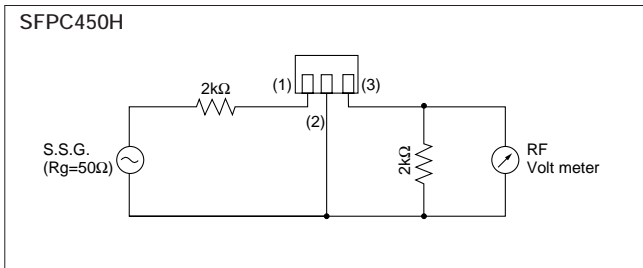

### ■ DIMENSIONS

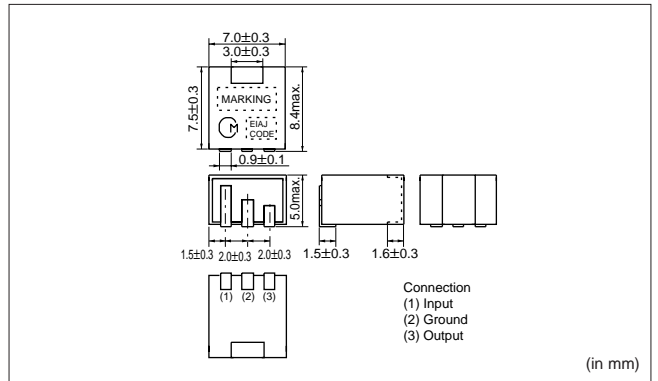

### ■ DIMENSIONS OF PLASTIC TAPE

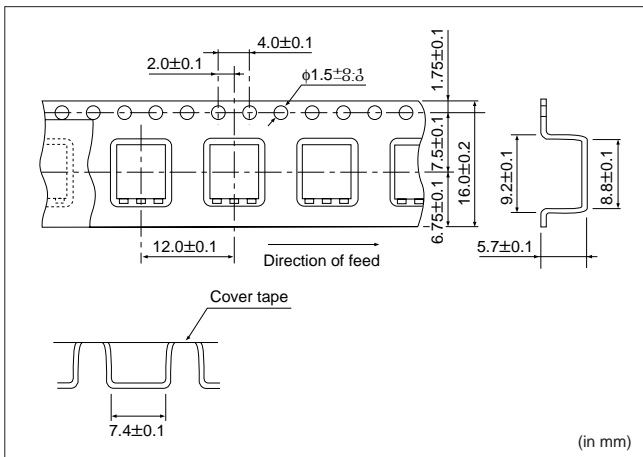



# CERAMIC FILTER

CERAFIL® is the Registered Trademark of Murata Manufacturing Co., Ltd.



## Two terminals Resonance Type Series 450 - 470kHz

### SPECIFICATION

Characteristics Part Number	Resonant Frequency (kHz)	fa-fr (kHz)	Resonant Resistance (Ω) max.	Capacitance (pF)
BFU450K3	450±1	27.5±4.5	30 (10)	550±20%
BFU450C	450±1	14±2	20 (10)	360±20%
BFU450C4N	450±0.8	9±2	30 (12)	360±20%

( ) : Typ. value

- fa-fr : Difference between the anti-resonant frequency and the resonant frequency.
- Most suitable for IC Station Detectors (SD) such as the LA 1135 (by Sanyo).

### IMPEDANCE CHARACTERISTICS

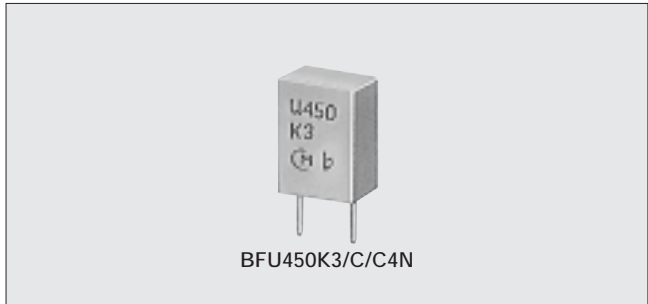
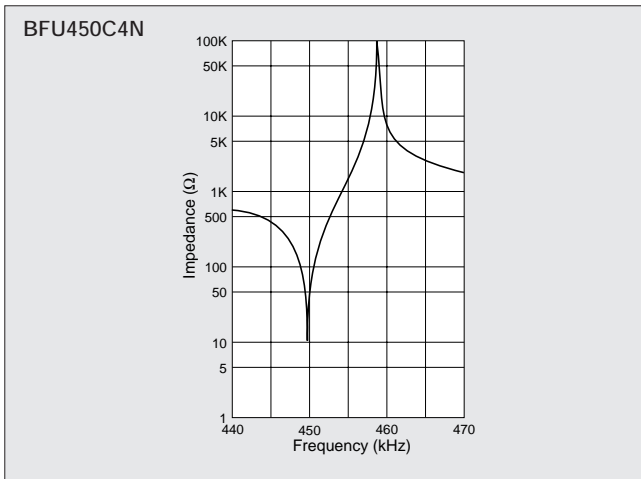

### DIMENSIONS

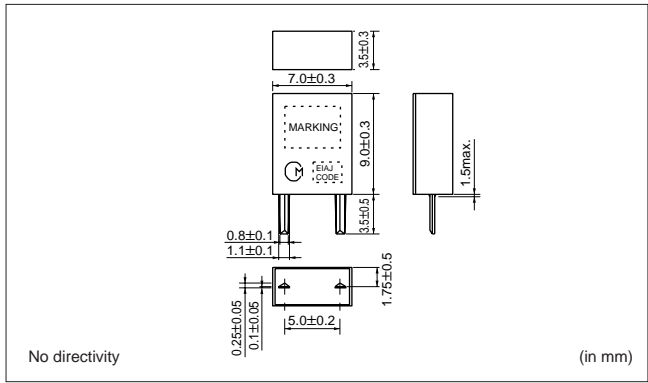

### APPLICATION CIRCUIT

#### ● BFU450K3 in Tr Circuit

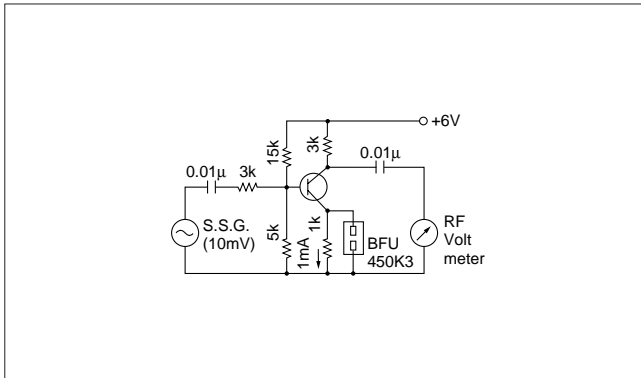

#### ● BFU450C4N IN LA1135 (for SD)

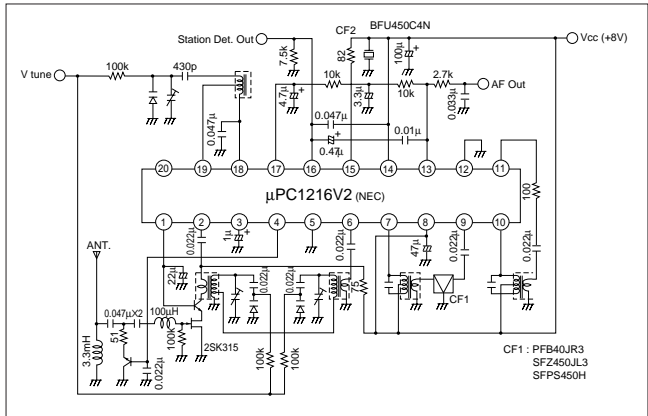

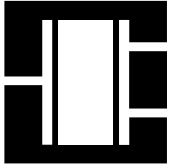

# CERAMIC FILTER

CERAFIL® is the Registered Trademark of Murata Manufacturing Co., Ltd.



## SF□/PF□/BF Series Temperature

### TEMPERATURE CHARACTERISTICS

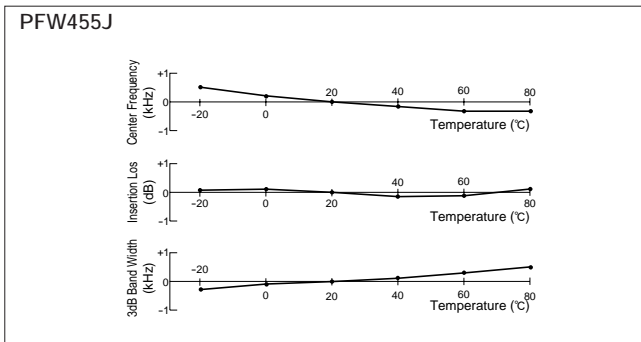
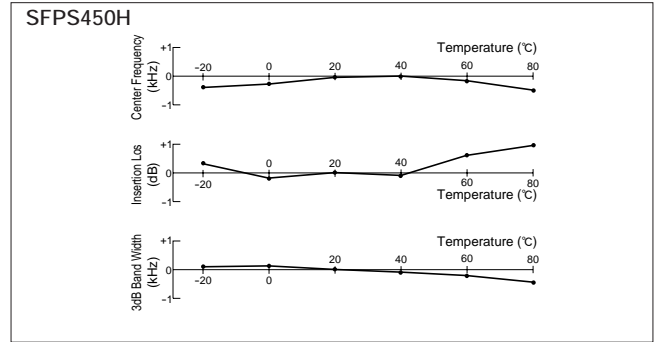
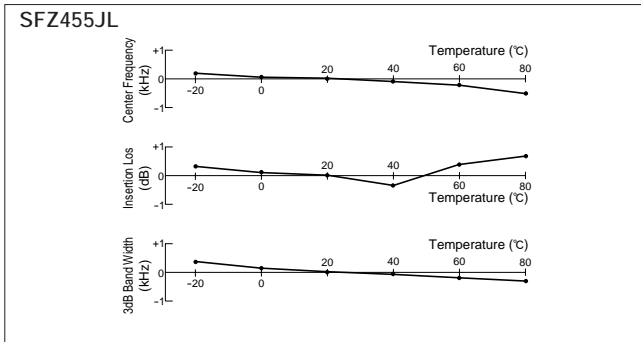

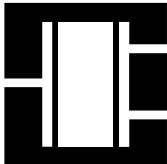

# CERAMIC FILTER

CERAFIL® is the Registered Trademark of Murata Manufacturing Co., Ltd.



## SF□/PF□/BF Series Application

### APPLICATION CIRCUIT

#### ● Car Radio (SFPS450H/BFU450C4N)

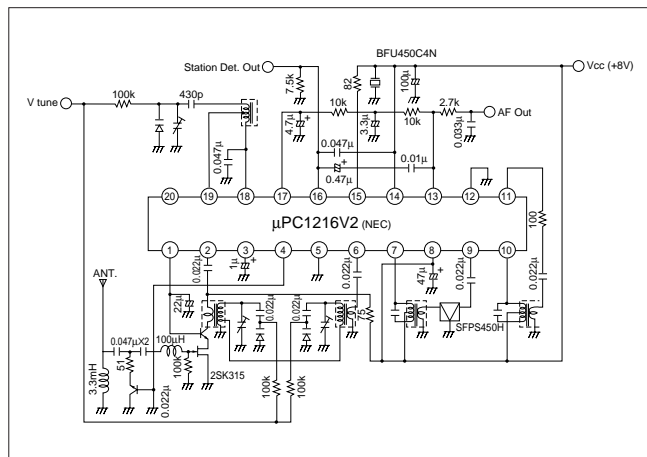

#### ● Car Radio (SFZ455JL3/SFU455A3)

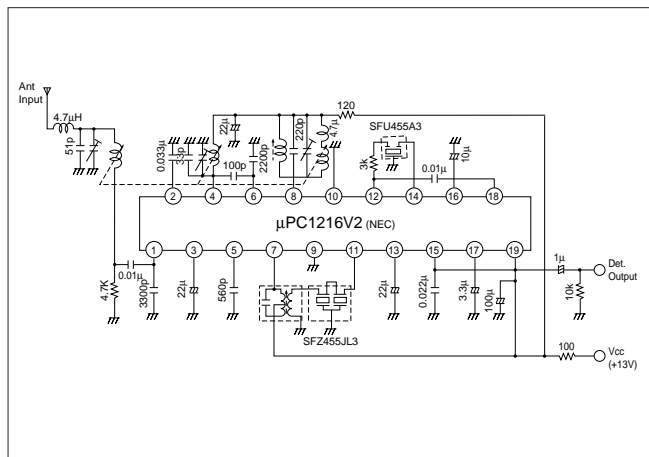

#### ● Portable Radio (SFU455B)

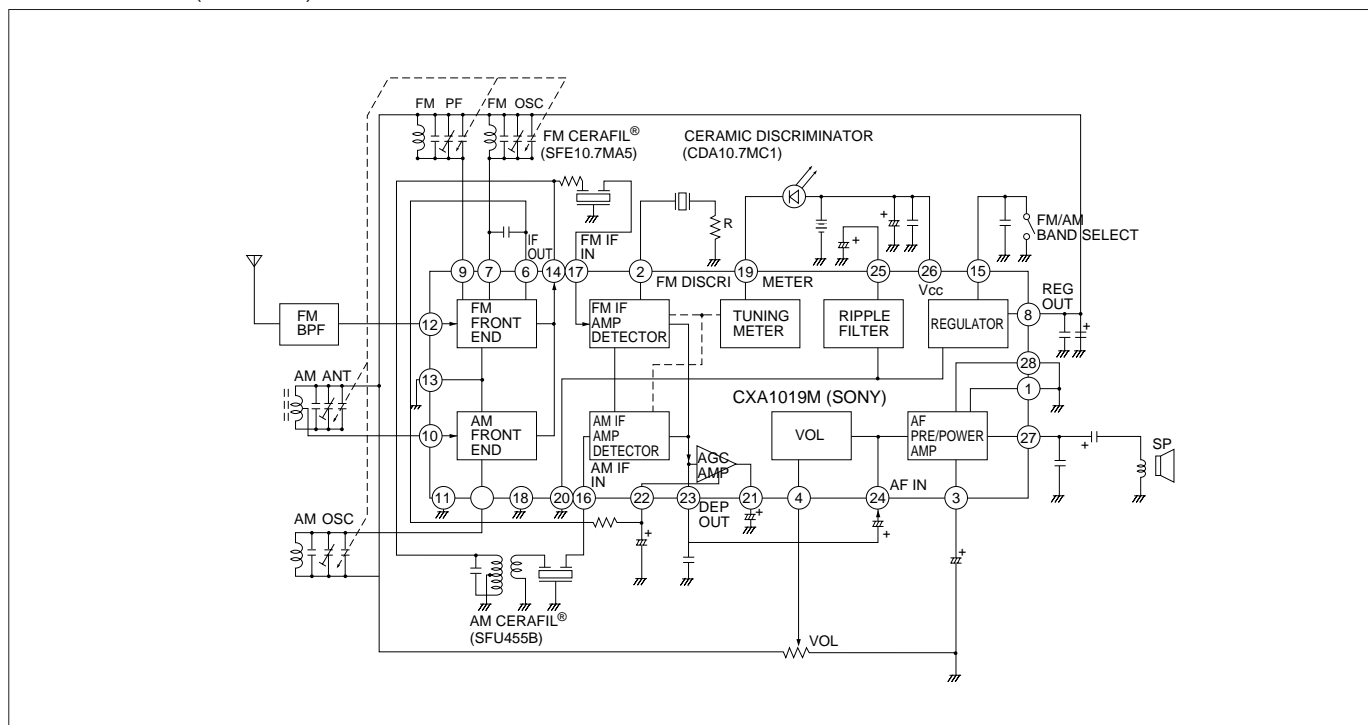

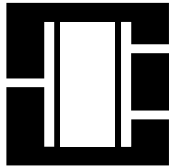

# CERAMIC FILTER

CERAFIL® is the Registered Trademark of Murata Manufacturing Co., Ltd.



## SF□/PF□/BF Series Application/Notice

### ● Portable Radio (SFU455B)

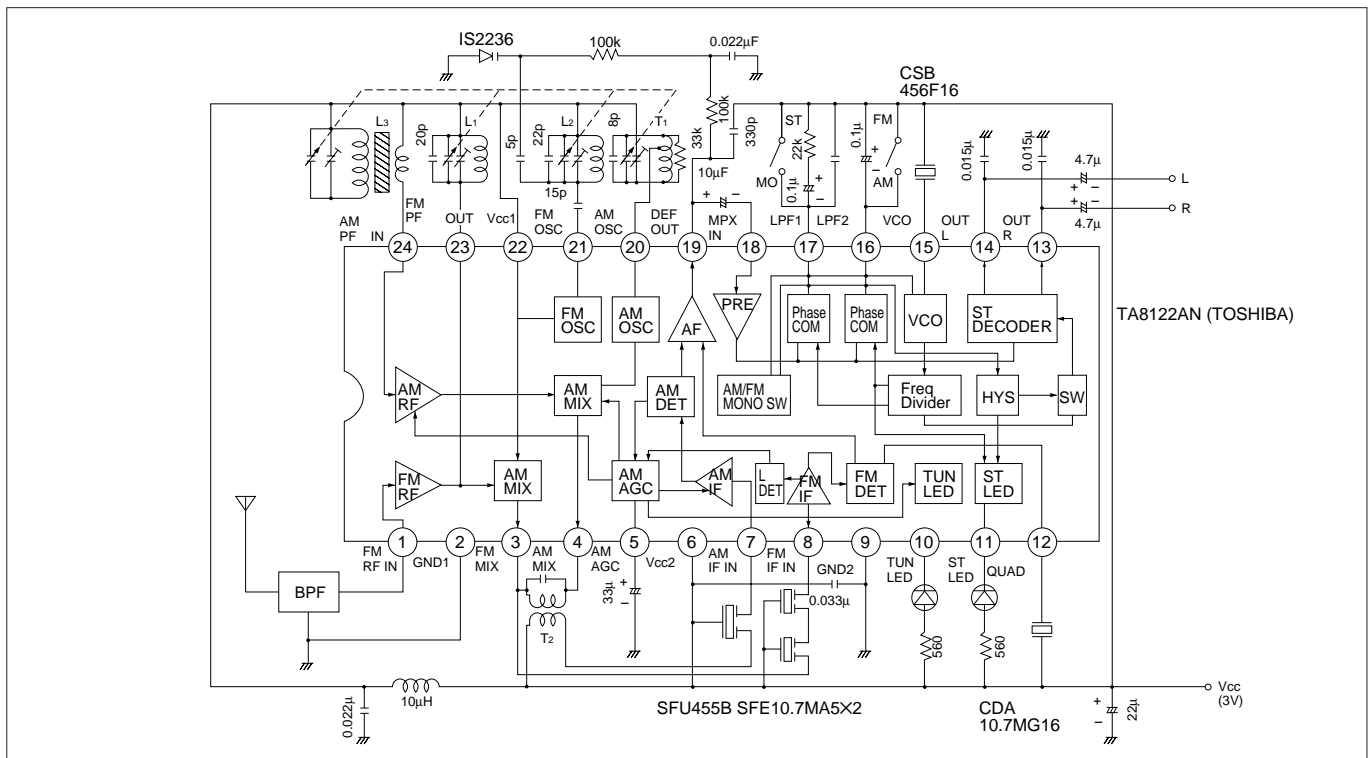

### ■ NOTICE

- Matching condition should be evaluated to perform stable electrical characteristics which are specified.
- In case of covering filter with over coat, conditions, such as material of resin, cure temperature and so on should be evaluated well.
- Washing of filter is not acceptable due to unsealed construction.
- Filter might be damaged when an excess stress was applied.

**⚠ Note:****1. Export Control**

⟨For customers outside Japan⟩

Murata products should not be used or sold for use in the development, production, stockpiling or utilization of any conventional weapons or mass-destructive weapons (nuclear weapons, chemical or biological weapons, or missiles), or any other weapons.

⟨For customers in Japan⟩

For products which are controlled items subject to the "Foreign Exchange and Foreign Trade Law" of Japan, the export license specified by the law is required for export.

**2. Please contact our sales representatives or product engineers before using our products listed in this catalog for the applications listed below which require especially high reliability for the prevention of defects which might directly cause damage to the third party's life, body or property, or when intending to use one of our products for other applications than specified in this catalog.**

- ① Aircraft equipment
- ② Aerospace equipment
- ③ Undersea equipment
- ④ Medical equipment
- ⑤ Transportation equipment (vehicles, trains, ships, etc.)
- ⑥ Traffic signal equipment
- ⑦ Disaster prevention / crime prevention equipment
- ⑧ Data-processing equipment
- ⑨ Application of similar complexity and/or reliability requirements to the applications listed in the above

**3. Product specifications in this catalog are as of May 1999. They are subject to change or our products in it may be discontinued without advance notice. Please check with our sales representatives or product engineers before your ordering. If there are any questions, please contact our sales representatives or product engineers.****4. The parts numbers and specifications listed in this catalog are for information only. You are requested to approve our product specification or to transact the approval sheet for product specification, before your ordering.****5. Please note that unless otherwise specified, we shall assume no responsibility whatsoever for any conflict or dispute that may occur in connection with the effect of our and/or third party's intellectual property rights and other related rights in consideration of your using our products and/or information described or contained in our catalogs. In this connection, no representation shall be made to the effect that any third parties are authorized to use the rights mentioned above under licenses without our consent.****6. None of ozone depleting substances (ODS) under the Montreal Protocol is used in manufacturing process of us.**