

Specification

Technical Specification

- 1.The surface is clean after whole assembling,without injury、hollow,the base has no crack;
- 2.The button is flexible when people press it,the sound is clear,without any stop、noise.
- 3.The sizes which haven't been noted is set according to (GB/T14486-2008-MT6B);
- 4.Circuit Diagram:

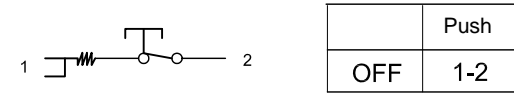
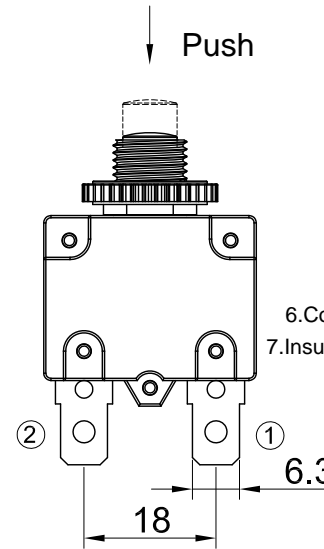
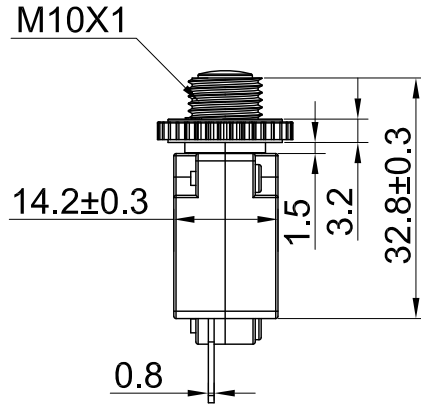
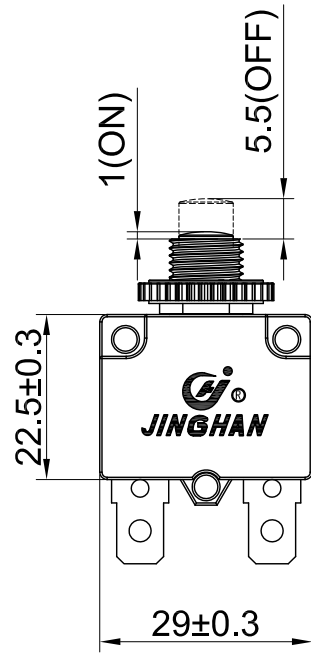

5 Rated Ampere And Voltage:

TUV.CE : 20A 125/250V AC. 50/60Hz 48V DC T85/55 5E4

6.Contact resistance : ≤50mΩ

7.Insulated resistance : ≥100MΩ

8.Dielectric strength : 1500VAC/5S

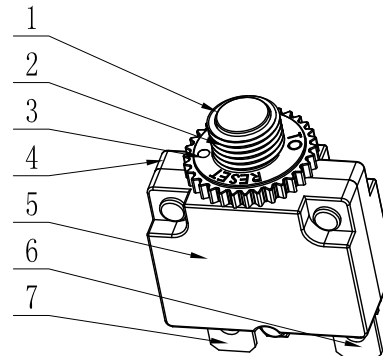
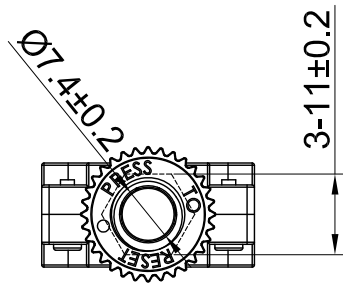

7	Left side pin	H62Y2	1	copper tin plating
6	Right side pin	H62Y2	1	copper tin plating
5	Upper cover	PA66	1	Black
4	Bottom cover	PA66	1	Black
3	Nut	PA66	1	Black
2	threaded column	PA66	1	Black
1	Button	PA66	1	Red
NO	Name	Material	Quan.	Noted

Size : 尺寸

Ratio

1:1

Des :

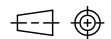

Unit

mm

Exa :

Name :

KBF-1-01

NO :

KBF-1



乐清市晶瀚电子有限公司

YUEQING JINGHAN ELECTRONIC CO.,LTD

地址:浙江省乐清市蒲岐镇特色工业园区

电话:0577-62306675 62308875 传真: 0577-62308861

Mark change content

Date

Edition : A/0

Page : 1/1

App :