

LARGE CAN TYPE

KP

Series

Screw Terminal Type

JAMICON®

- High ripple current characteristic.
- Long life for 2000 hours at 85°C.



● SPECIFICATION

Item	Characteristic		
Operation Temperature Range	-40 ~ +85°C	-25 ~ +85°C	
Rated Working Voltage	6.3 ~ 100VDC	160 ~ 450VDC	
Capacitance Tolerance (120Hz 20°C)	±20%(M)		
Leakage Current (20°C)	$I \leq 0.02CV$ or 5 (mA) *Whichever is smaller after 5 minutes I : Leakage Current(μA) C : Rated Capacitance(μF) V : Working Voltage(V)		
Surge Voltage (20°C)	W.V.	6.3 10 16 25 35 50 63 80 100 160 200 250 300 400 450	
	S.V.	8 13 20 32 44 63 79 100 125 200 250 300 400 450 500	
Dissipation Factor (tan δ) (120Hz 20°C)	W.V.	6.3 10 16 25 35 50 63 80 100 160 200 250 300 400 450	
	tan δ	φ35	0.75 0.75 0.60 0.40 0.30 0.25 0.20 0.20 0.15 0.15 0.15 0.15 0.20 0.20 0.20
		φ51	1.00 1.00 0.70 0.50 0.50 0.30 0.25 0.20 0.20 0.15 0.15 0.15 0.20 0.20 0.20
		φ64	1.30 1.30 0.80 0.70 0.60 0.50 0.30 0.25 0.25 0.20 0.20 0.20 0.25 0.25 0.25
		φ77	1.50 1.50 1.00 0.80 0.70 0.60 0.40 0.30 0.25 0.20 0.20 0.20 0.25 0.25 0.25
φ90	1.50 1.50 1.00 0.80 0.70 0.60 0.40 0.30 0.25 0.20 0.20 0.20 0.25 0.25 0.25		
Low Temperature Stability	Impedance ratio at 120Hz		
	Rated Voltage (V)	10~100 160~450	
	-25°C / +20°C	8	
	-40°C / +20°C	12	
Load Life	After 2000 hours application of W.V. and +85°C ripple current value, the capacitor shall meet the following limits. (DC + ripple peak voltage ≤ rate working voltage)		
	Capacitance Change	≤ ±15% of initial value	
	Dissipation Factor	≤ 175% of initial specified value	
	Leakage current	≤ initial specified value	
Shelf Life	At +85°C, no voltage application after 1000 hours, the capacitor shall meet the limits for load life characteristics. (With voltage treatment)		

● TERMINAL TYPE

φD	W1	W2	W3	W4	W5	P
35	24.0	30.0	7.0	3.5	10.0	12.7
51	32.5	37.5	4.5	7.0	13.0	21.8
64	38.5	42.8	4.5	7.0	13.0	28.2
77	44.8	49.0	4.5	7.0	13.0	31.4
90	52.3	58.8	5.0	8.0	16.0	31.4

● RIPPLE CURRENT COEFFICIENTS

Frequency(Hz)	60	120	1k	10k	100k
W.V.	Multiplier				
6.3 ~ 35V	0.90	1.00	1.05	1.10	1.10
50 ~ 100V	0.90	1.00	1.10	1.15	1.15
160 ~ 450V	0.80	1.00	1.20	1.40	1.40

Temperature(°C)	≤60	70	85
Multiplier	1.80	1.60	1.00

(▲ φ35)

(▲ φ51, φ64, φ77, φ90)

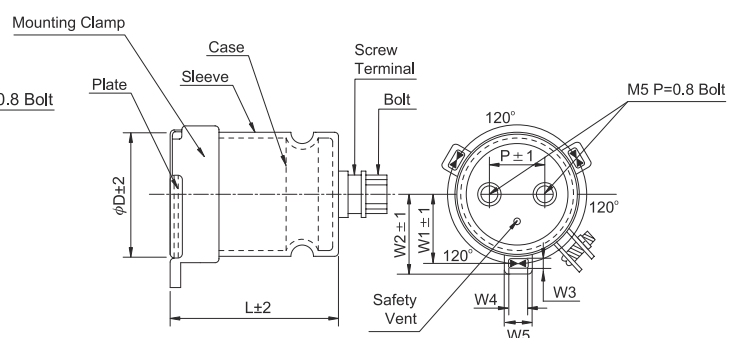
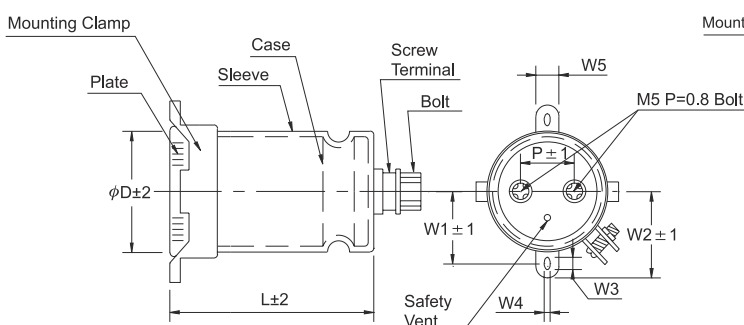

● CASE SIZE & MAX RIPPLE CURRENT

Case size : D x L (mm)
 Max ripple current : A(rms) 85°C 120Hz

μF	V(Code)		6.3 (0J)		10 (1A)		16 (1C)	
	Code	Item	DxL	R.C.	DxL	R.C.	DxL	R.C.
22000	223						35x50	4.16
33000	333				35x50	4.14	35x60	5.51
39000	393				35x50	4.50	35x80	6.80
47000	473		35x50	4.94	35x60	5.35	35x80	7.47
56000	563		35x60	4.96	35x80	6.63	35x100	9.03
68000	683		35x60	5.47	35x80	7.31	35x121	9.88
82000	823		35x80	6.82	35x80	8.02	35x121	10.85
100000	104		35x80	7.53	35x121	9.21	51x80	10.86
120000	124		35x121	9.15	51x80	9.23	51x90	11.74
150000	154		51x80	9.51	51x80	10.32	51x121	12.48
180000	184		51x80	10.42	51x90	11.50	51x121	13.67
220000	224		51x100	12.39	51x121	13.66	64x100	14.75
270000	274		64x100	13.68	51x121	15.13	64x115	17.37
330000	334		64x100	15.12	64x121	17.25	77x121	18.19
390000	394		64x121	16.97	64x121	18.75	77x121	19.78
470000	474		64x121	18.63	77x121	19.25		
560000	564		77x121	18.80	77x121	21.01		
680000	684		77x121	20.71				

μF	V(Code)		25 (1E)		35 (1V)		50 (1H)	
	Code	Item	DxL	R.C.	DxL	R.C.	DxL	R.C.
6800	682						35x50	3.26
8200	822						35x50	3.58
10000	103				35x50	3.53	35x60	4.27
12000	123				35x50	3.87	35x60	4.68
15000	153				35x60	3.96	35x80	5.94
18000	183		35x50	3.35	35x60	4.34	35x80	6.51
22000	223		35x60	4.01	35x80	4.93	35x121	6.70
27000	273		35x80	5.04	35x80	5.46	35x121	7.42
33000	333		35x80	5.58	35x121	7.20	51x80	7.55
39000	393		35x80	6.06	35x121	7.83	51x80	8.20
47000	473		35x121	7.54	51x80	8.26	51x100	9.80
56000	563		35x121	8.23	51x80	9.02	51x100	10.70
68000	683		51x100	9.13	51x100	10.35	64x100	11.34
82000	823		51x100	10.03	51x100	11.36	64x100	12.46
100000	104		51x121	11.26	64x100	11.48	64x144	12.81
120000	124		51x121	12.33	64x121	13.13	64x144	14.03
150000	154		64x100	12.68	64x144	15.42	77x144	15.86
180000	184		64x100	13.89	64x144	16.89		
220000	224		64x144	16.05	77x144	17.79		
270000	274		77x115	17.80				
330000	334		77x144	20.38				

● CASE SIZE & MAX RIPPLE CURRENT

Case size : D x L (mm)
 Max ripple current : A(rms) 85°C 120Hz

μF	V(Code)		63 (1J)		80 (1K)		100 (2A)	
	Code	Item	DxL	R.C.	DxL	R.C.	DxL	R.C.
2200	222						35x50	2.15
2700	272						35x50	2.38
3300	332						35x50	2.64
3900	392						35x60	3.10
4700	472				35x50	2.72	35x80	3.87
5600	562		35x50	2.97	35x60	3.22	35x80	4.22
6800	682		35x50	3.28	35x80	4.03	35x100	5.15
8200	822		35x60	3.89	35x80	4.42	35x121	5.83
10000	103		35x80	4.77	35x100	5.41	51x80	6.03
12000	123		35x80	5.23	35x121	6.47	51x80	6.60
15000	153		35x100	5.88	51x80	7.63	51x121	8.86
18000	183		35x121	6.16	51x80	8.35	51x121	9.71
22000	223		51x80	7.73	51x100	8.76	64x100	9.79
27000	273		51x80	8.56	51x100	9.70	64x100	10.85
33000	333		51x100	8.76	64x100	10.22	64x144	12.80
39000	393		51x121	10.22	64x100	11.11	77x115	13.11
47000	473		64x100	11.88	64x144	14.33	77x144	14.81
56000	563		64x100	12.96	64x144	15.64		
68000	683		64x144	13.63	77x144	16.27		
100000	104		77x144	15.86				

μF	V(Code)		160 (2C)		200 (2D)		250 (2E)	
	Code	Item	DxL	R.C.	DxL	R.C.	DxL	R.C.
470	471						35x50	1.66
560	561						35x50	1.81
680	681				35x50	1.99	35x50	1.99
820	821				35x50	2.19	35x60	2.37
1000	102				35x60	2.62	35x80	2.87
1200	122		35x50	2.64	35x60	2.87	35x80	3.15
1500	152		35x60	3.20	35x80	3.52	35x100	3.49
1800	182		35x70	3.63	35x80	3.85	35x100	3.83
2200	222		35x80	4.26	35x100	4.23	51x70	4.28
2700	272		35x100	4.68	35x121	4.72	51x70	4.74
3300	332		35x121	5.22	51x70	5.24	51x90	5.38
3900	392		51x70	5.70	51x70	5.70	51x115	6.23
4700	472		51x70	6.26	51x90	6.42	64x96	7.06
5600	562		51x90	7.00	51x115	7.47	64x96	7.71
6800	682		51x90	7.72	51x130	8.70	64x115	9.19
8200	822		51x115	9.04	64x96	9.33	64x115	10.09
10000	103		64x96	10.30	64x96	10.30	64x130	11.76
12000	123		64x96	11.29	77x96	12.56	77x115	13.01
15000	153		64x130	13.83	77x96	14.04	77x130	14.70
18000	183		64x130	15.15	77x130	16.80	77x155	17.40
22000	223		77x130	18.57	77x155	20.07	90x157	20.19
27000	273		77x130	20.58	90x131	21.62		
33000	333		90x131	23.90	90x157	25.85		
39000	393		90x157	28.10				

● CASE SIZE & MAX RIPPLE CURRENT

Case size : D x L (mm)
 Max ripple current : A(rms) 85°C 120Hz

μF	V(Code)		350 (2V)		400 (2G)		450 (2W)	
	Code	Item	DxL	R.C.	DxL	R.C.	DxL	R.C.
270	271						35x50	1.45
330	331				35x80	1.97	35x80	1.97
390	391		35x50	1.74	35x80	2.14	35x80	2.14
470	471		35x80	2.35	35x80	2.35	35x80	2.35
560	561		35x80	2.57	35x80	2.57	35x100	2.63
680	681		35x80	2.83	35x100	2.90	35x100	2.90
820	821		35x100	3.18	35x100	3.18	51x70	3.26
1000	102		35x100	3.51	51x70	3.60	51x70	3.60
1200	122		51x70	3.94	51x70	3.94	51x90	4.39
1500	152		51x70	4.41	51x90	4.91	51x115	5.17
1800	182		51x90	5.38	51x90	5.38	51x130	5.64
2200	222		51x90	5.95	51x130	6.23	64x96	6.40
2700	272		51x130	6.91	64x96	7.09	64x115	7.25
3300	332		51x130	7.63	64x115	8.01	64x130	8.22
3900	392		64x115	8.71	64x130	8.94	77x115	9.40
4700	472		64x130	9.81	77x115	10.32	77x130	10.88
5600	562		77x115	11.26	77x130	11.87	77x155	12.83
6800	682		77x130	13.08	77x155	14.14	90x157	14.60
8200	822		77x155	15.53	90x157	16.03	90x157	16.03
10000	103		90x157	17.71	90x157	17.71	90x196	19.53
12000	123		90x157	19.40	90x196	21.40	90x236	23.28
15000	153		90x196	23.93	90x236	26.02		
18000	183		90x236	28.51				