



● **Application**

Microcomputer, VTR, Toys, TV Game, Telecommunications...etc

● **Specification**

| | |
|-----------------------------|--|
| Frequency Range | 1.5 ~ 160.0 MHz |
| Vibration Mode | AT Cut: Fundamental, Third, Fifth |
| Frequency Tolerance at 25°C | +/-10, +/-15, +/-20, +/-30, +/-50 ppm |
| Shunt Capacitance | 7.0pF max. or specified |
| Load Capacitance | 16, 20, 30pF, Series Resonant or specified |
| Drive Level | 10, 100, 300, 1000uW or specified |
| Insulation Resistance | 500M Ohm min. at DC 100V |
| Aging | +/- 3, 5 ppm per year or specified |

● **Operating Temperature Range & Frequency Stability**

| Temp. ppm | +/-3 | +/-5 | +/-7.5 | +/-10 | +/-15 | +/-20 | +/-30 | +/-50 |
|-------------|------|------|--------|-------|-------|-------|-------|-------|
| 0 ~ +50°C | ■ O | ■ O | ■ O | ■ O* | ■ O* | ■ O* | ■ O* | ■ O* |
| -10 ~ +60°C | ■ O | ■ O | ■ O | ■ O* | ■ O* | ■ O* | ■ O* | ■ O* |
| -20 ~ +70°C | | ■ O | ■ O | ■ O | ■ O | ■ O* | ■ O* | ■ O* |
| -30 ~ +80°C | | | | ■ O | ■ O | ■ O | ■ O* | ■ O* |
| -40 ~ +90°C | | | | ■ O | ■ O | ■ O | ■ O | ■ O* |

HC49U & 50U Series : O
HC49S Series : *
UM Series : ■

● **Frequency Range & Equivalent Series Resistance (Unit: Ohm)**

| Frequency (MHz) | Vibration Mode | HC-49/U HC-50/U | HC-49/U1 HC-50/U1 | HC-49/U2 HC-50/U2 | HC-49/U3 HC-50/U3 |
|-------------------|----------------|--------------------|----------------------|----------------------|----------------------|
| 1.5 ~ 1.99 | Fundamental | 700 | | | |
| 2.0 ~ 2.99 | Fundamental | 500 | | | 600 |
| 3.0 ~ 3.19 | Fundamental | 300 | | | 400 |
| 3.2 ~ 3.99 | Fundamental | 150 | | | 200 |
| 4.0 ~ 4.49 | Fundamental | 90 | | | 150 |
| 4.5 ~ 4.99 | Fundamental | 70 | | 100 | 80 |
| 5.0 ~ 6.99 | Fundamental | 50 | | 60 | 60 |
| 7.0 ~ 9.99 | Fundamental | 35 | | 40 | 40 |
| 10.0 ~ 30.0 | Fundamental | 25 | 35 | 25 | 25 |
| 20.0 ~ 24.99 | Third Overtone | 45 | | 50 | 50 |
| 25.0 ~ 90.0 | Third Overtone | 40 | 50 | 40 | 40 |
| 70.0 ~ 160.0 | Fifth Overtone | 70 | 70 | 70 | 70 |

● **Frequency Range & ESR (Unit: Ohm)**

| Frequency (MHz) | Vibration Mode | LP Series |
|-------------------|----------------|-----------|
| 3.2 ~ 3.79 | Fundamental | 180 |
| 3.8 ~ 4.49 | Fundamental | 150 |
| 4.5 ~ 5.99 | Fundamental | 120 |
| 6.0 ~ 7.99 | Fundamental | 100 |
| 8.0 ~ 9.99 | Fundamental | 80 |
| 10.0 ~ 11.9 | Fundamental | 70 |
| 12.0 ~ 15.9 | Fundamental | 60 |
| 16.0 ~ 19.9 | Fundamental | 50 |
| 20.0 ~ 25.9 | Fundamental | 40 |
| 26.0 ~ 39.9 | Third Overtone | 100 |
| 40.0 ~ 79.9 | Third Overtone | 80 |
| 80.0 ~ 100.0 | Third Overtone | 100 |

● **Frequency Range & ESR (Unit: Ohm)**

| Frequency (MHz) | Vibration Mode | UM-1 UM-1 Slim | UM-5 UM-4 |
|-------------------|----------------|-------------------|--------------|
| 3.5 ~ 3.9 | Fundamental | 200 | |
| 4.0 ~ 4.99 | Fundamental | 150 | |
| 5.0 ~ 9.9 | Fundamental | 60 | |
| 10.0 ~ 14.9 | Fundamental | 40 | 60 |
| 15.0 ~ 50.0 | Fundamental | 30 | 35 |
| 30.0 ~ 49.9 | Third Overtone | 45 | 50 |
| 50.0 ~ 100.0 | Third Overtone | 60 | 60 |
| 75.0 ~ 160.0 | Fifth Overtone | 80 | 90 |

● **Dimension (unit: mm)**

HC49U

| HOLDER | H |
|--------|------|
| HC49U | 13.0 |
| HC49U1 | 9.5 |
| HC49U2 | 11.0 |
| HC49U3 | 11.4 |

HC50U

| HOLDER | H |
|--------|------|
| HC50U | 13.1 |
| HC50U1 | 9.5 |
| HC50U2 | 11.0 |
| HC50U3 | 11.4 |

HC49S-2.0,2.5,3.5

| HOLDER | H |
|-----------|-----|
| HC49S-2.2 | 2.2 |
| HC49S-2.5 | 2.5 |
| HC49S-3.5 | 3.5 |

UM-1 Slim

| HOLDER | H |
|--------|-----|
| UM-1 | 8.2 |
| UM-4 | 4.6 |
| UM-5 | 6.0 |

UM-1, UM-4, UM-5

● Tape Specification

Item 1:

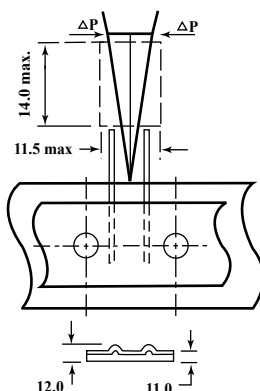
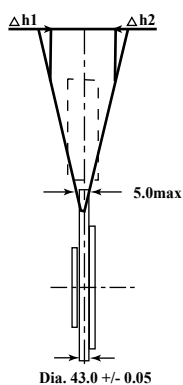
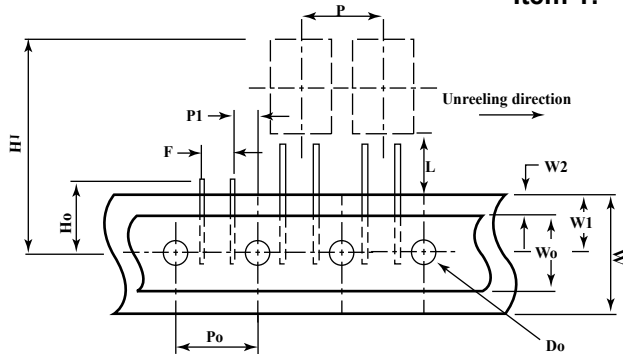

| Symbol | Dimension Tolerance (mm) | |
|--------|----------------------------|------------|
| P | 12.7+/-1.0 | |
| Po | 12.7+/-0.3 | |
| P1 | 3.85+/-0.7 | |
| F | 5.0+/-0.8 | |
| W | 18.0+1.0/-0.5 | |
| Wo | 12.5 or more | |
| W1 | 9.0+0.75/-0.5 | |
| W2 | 3.0 or less | |
| Do | 4.0+/-0.2 | |
| L | 9.5 or more | |
| t1 | 0.6+/-0.3 | |
| t2 | 1.5 or less | |
| Δ h1 | 2.0 or less | |
| Δ h2 | 2.0 or less | |
| Δ P | 2.0 or less | |
| Ho | | 4.0+/- 0.2 |
| H1 | 34.46 or less | xs;24.86 |

Item 2:

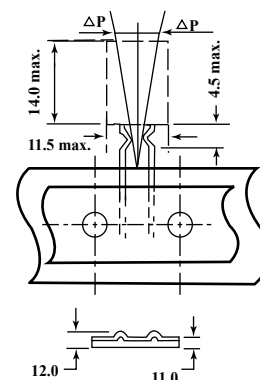
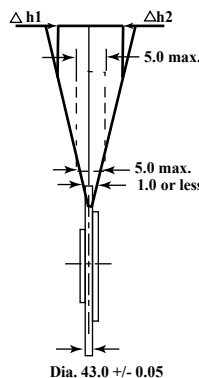
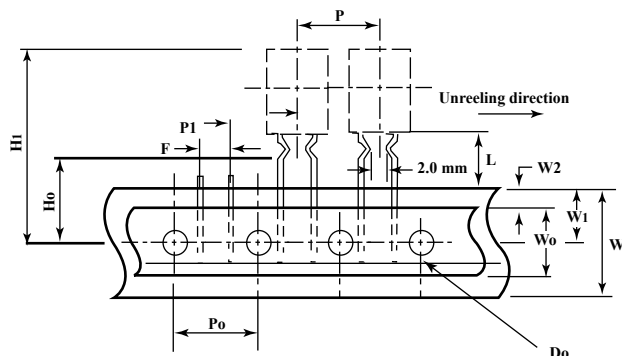

● Reel Specification

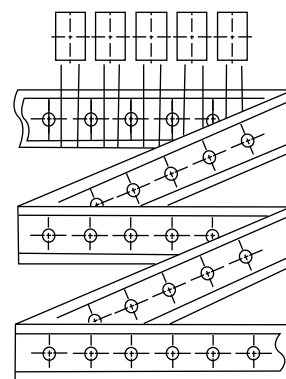
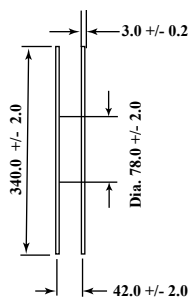
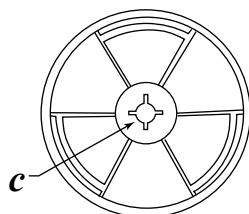

● C Enlarge

● Tape Arrange



● Application

Radio Communication, AV Equipment, Office Automation Equipment, Consumer Products...etc

● Specification

| | |
|-----------------------------|--|
| Frequency Range | 1.5 ~ 160.0 MHz |
| Vibration Mode | AT Cut: Fundamental, Third, Fifth |
| Frequency Tolerance at 25°C | +/-10, +/-15, +/-20, +/-30, +/-50 ppm |
| Shunt Capacitance | 7.0pF max. or specified |
| Load Capacitance | 16, 20, 30pF, Series Resonant or specified |
| Drive Level | 10, 100, 300, 1000uW or specified |
| Insulation Resistance | 500M Ohm min. at DC 100V |
| Aging | +/- 3, 5 ppm per year or specified |

● Operating Temperature Range & Frequency Stability

| Temp.\ppm | +/-3 | +/-5 | +/-7.5 | +/-10 | +/-15 | +/-20 | +/-30 | +/-50 |
|-------------|------|------|--------|-------|-------|-------|-------|-------|
| 0 ~ +50°C | ■ ○ | ■ ○ | ■ ○ | ■ ○* | ■ ○* | ■ ○* | ■ ○* | ■ ○* |
| -10 ~ +60°C | ■ ○ | ■ ○ | ■ ○ | ■ ○* | ■ ○* | ■ ○* | ■ ○* | ■ ○* |
| -20 ~ +70°C | | ■ ○ | ■ ○ | ■ ○ | ■ ○* | ■ ○* | ■ ○* | ■ ○* |
| -30 ~ +80°C | | | | ■ ○ | ■ ○ | ■ ○ | ■ ○* | ■ ○* |
| -40 ~ +90°C | | | | | ■ ○ | ■ ○ | ■ ○ | ■ ○* |

HC49U & 50U Series : ○
 HC49S Series : *
 UM Series : ■

● Frequency Range & Equivalent Series Resistance (Unit: Ohm)

| Frequency (MHz) | Vibration Mode | HC-49/U HC-50/U | HC-49/U1 HC-50/U1 | HC-49/U2 HC-50/U2 | HC-49/U3 HC-50/U3 |
|-------------------|----------------|--------------------|----------------------|----------------------|----------------------|
| 1.5 ~ 1.99 | Fundamental | 700 | | | |
| 2.0 ~ 2.99 | Fundamental | 500 | | | 600 |
| 3.0 ~ 3.19 | Fundamental | 300 | | | 400 |
| 3.2 ~ 3.99 | Fundamental | 150 | | | 200 |
| 4.0 ~ 4.49 | Fundamental | 90 | | | 150 |
| 4.5 ~ 4.99 | Fundamental | 70 | | 100 | 80 |
| 5.0 ~ 6.99 | Fundamental | 50 | | 60 | 60 |
| 7.0 ~ 9.99 | Fundamental | 35 | | 40 | 40 |
| 10.0 ~ 30.0 | Fundamental | 25 | 35 | 25 | 25 |
| 20.0 ~ 24.99 | Third Overtone | 45 | | 50 | 50 |
| 25.0 ~ 90.0 | Third Overtone | 40 | 50 | 40 | 40 |

● Frequency Range & ESR (Unit: Ohm)

| Frequency (MHz) | Vibration Mode | LP Series |
|-------------------|----------------|-----------|
| 3.2 ~ 3.79 | Fundamental | 180 |
| 3.8 ~ 4.49 | Fundamental | 150 |
| 4.5 ~ 5.99 | Fundamental | 120 |
| 6.0 ~ 7.99 | Fundamental | 100 |
| 8.0 ~ 9.99 | Fundamental | 80 |
| 10.0 ~ 11.9 | Fundamental | 70 |
| 12.0 ~ 15.9 | Fundamental | 60 |
| 16.0 ~ 19.9 | Fundamental | 50 |
| 20.0 ~ 25.9 | Fundamental | 40 |
| 26.0 ~ 39.9 | Third Overtone | 100 |
| 40.0 ~ 59.9 | Third Overtone | 80 |
| 60.0 ~ 79.9 | Third Overtone | 60 |
| 80.0 ~ 100.0 | Third Overtone | 60 |

● Frequency Range & ESR (Unit: Ohm)

| Frequency (MHz) | Vibration Mode | UM-1 UM-1 Slim | UM-5 UM-4 |
|-------------------|----------------|-------------------|--------------|
| 3.5 ~ 3.9 | Fundamental | 200 | |
| 4.0 ~ 4.99 | Fundamental | 150 | |
| 5.0 ~ 9.9 | Fundamental | 60 | |
| 10.0 ~ 14.9 | Fundamental | 40 | 60 |
| 15.0 ~ 50.0 | Fundamental | 30 | 35 |
| 30.0 ~ 49.9 | Third Overtone | 45 | 50 |
| 50.0 ~ 100.0 | Third Overtone | 60 | 60 |
| 75.0 ~ 160.0 | Third Overtone | 80 | 90 |

● Dimension (unit: mm)

HC49U (SMD)



| HOLDER | H | L |
|--------|------|-------|
| HC49U | 13.1 | 17.06 |
| HC49U1 | 9.5 | 13.46 |
| HC49U2 | 11.0 | 14.96 |
| HC49U3 | 11.4 | 15.36 |

SMD49S-3.0S,3.5S,5.0S (HC49S SMD Type)



| HOLDER | H |
|------------|-----|
| SMD49-3.0S | 3.0 |
| SMD49-3.5S | 3.5 |
| SMD49-5.0S | 5.0 |

UM-1S, UM-4S, UM-5S (SMD)



| HOLDER | H | L |
|--------|-----|------|
| UM-1S | 7.7 | 11.7 |
| UM-4S | 4.6 | 8.6 |
| UM-5S | 5.9 | 9.9 |

CRYSTAL UNITS (DIP TYPE)



● Tape Specification Item 1 : (49U, SMD49S, UM-1)



| Symbol | Dimension Tolerance (mm) | | |
|----------------|--------------------------|------------|------------|
| | 49U | SMD49S | UM-1 |
| W | 32.0+/-0.3 | 24.0+/-0.3 | 24.0+/-0.3 |
| W ₀ | 14.2+/-0.1 | 11.5+/-0.1 | 11.5+/-0.1 |
| W ₁ | 18.0+/-0.2 | 13.0+/-0.1 | 13.9+/-0.1 |
| Lo | 11.2+/-0.1 | 5.1+/-0.1 | 8.7+/-0.1 |
| L1 | 16.0+/-0.1 | 12.0+/-0.1 | 12.0+/-0.1 |
| Ho | 0.4+/-0.05 | 0.4+/-0.05 | 0.3+/-0.05 |
| H1 | 4.8+/-0.1 | 2.0+/-0.01 | 2.2+/-0.1 |
| Dia.Do | 2.0+/-0.1 | 2.0+/-0.1 | 2.2+/-0.1 |

Item 2 : (UM-4, UM -5)

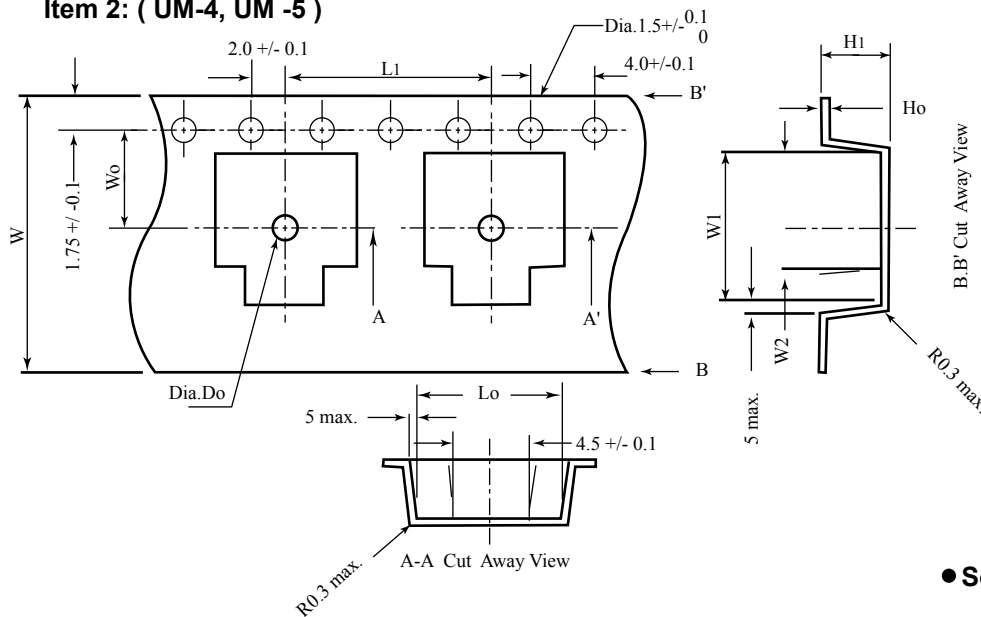

| Symbol | Dimension Tolerance (mm) | |
|----------------|--------------------------|------------|
| | UM-5 | UM-4 |
| W | 24.0+/-0.3 | 16.0+/-0.3 |
| W ₀ | 11.5+/-0.1 | 7.5+/-0.1 |
| W ₁ | 11.4+/-0.1 | 8.9+/-0.1 |
| W ₂ | 8.7+/-0.1 | 6.7+/-0.1 |
| L ₀ | 8.4+/-0.1 | 8.3+/-0.1 |
| L ₁ | 12.0+/-0.1 | 12.0+/-0.1 |
| H ₀ | 0.4+/-0.05 | 0.4+/-0.05 |
| H ₁ | 3.7+/-0.1 | 3.9+/-0.1 |
| Dia.Do | 2.0+/-0.1 | 1.6+/-0.1 |

● Reel Specification

C ENLARGE



| Dia D | Material |
|-------|---------------|
| 300 | Paper-Machine |
| 350 | Plastics |

● Solder Reflow Diagram

