



# Single/Dual LVDS Line Receivers with Ultra-Low Pulse Skew in SOT23

MAX9111/MAX9113

## General Description

The MAX9111/MAX9113 single/dual low-voltage differential signaling (LVDS) receivers are designed for high-speed applications requiring minimum power consumption, space, and noise. Both devices support switching rates exceeding 500Mbps while operating from a single +3.3V supply, and feature ultra-low 300ps (max) pulse skew required for high-resolution imaging applications such as laser printers and digital copiers.

The MAX9111 is a single LVDS receiver, and the MAX9113 is a dual LVDS receiver.

Both devices conform to the EIA/TIA-644 LVDS standard and convert LVDS to LVTTTL/CMOS-compatible outputs. A fail-safe feature sets the outputs high when the inputs are undriven and open, terminated, or shorted. The MAX9111/MAX9113 are available in space-saving 8-pin SOT23 and SO packages. Refer to the MAX9110/MAX9112 data sheet for single/dual LVDS line drivers.

## Applications

Laser Printers	Network Switches/Routers
Digital Copiers	LCD Displays
Cellular Phone Base Stations	Backplane Interconnect
Telecom Switching Equipment	Clock Distribution

## Features

- ◆ Low 300ps (max) Pulse Skew for High-Resolution Imaging and High-Speed Interconnect
- ◆ Space-Saving 8-Pin SOT23 and SO Packages
- ◆ Pin-Compatible Upgrades to DS90LV018A and DS90LV028A (SO Packages Only)
- ◆ Guaranteed 500Mbps Data Rate
- ◆ Low 29mW Power Dissipation at 3.3V
- ◆ Conform to EIA/TIA-644 Standard
- ◆ Single +3.3V Supply
- ◆ Flow-Through Pinout Simplifies PC Board Layout
- ◆ Fail-Safe Circuit Sets Output High for Undriven Inputs
- ◆ High-Impedance LVDS Inputs when Powered Off

## Ordering Information

PART	TEMP. RANGE	PIN-PACKAGE	TOP MARK
MAX9111EKA	-40°C to +85°C	8 SOT23	AAEE
MAX9111ESA	-40°C to +85°C	8 SO	—
MAX9113EKA	-40°C to +85°C	8 SOT23	AAED
MAX9113ESA	-40°C to +85°C	8 SO	—

Typical Operating Circuit appears at end of data sheet.

## Pin Configurations/Functional Diagrams/Truth Table

MAX9111  
SO

MAX9111  
SOT23

MAX9113  
SO

MAX9113  
SOT23

(IN <sub>+</sub> ) - (IN <sub>-</sub> )	OUT <sub>-</sub>
≥ 100mV	H
≤ -100mV	L
OPEN	H
SHORT	H
100Ω PARALLEL TERMINATION (UNDRIVEN)	H

H = LOGIC LEVEL HIGH  
L = LOGIC LEVEL LOW



# Single/Dual LVDS Line Receivers with Ultra-Low Pulse Skew in SOT23

## ABSOLUTE MAXIMUM RATINGS

V <sub>CC</sub> to GND .....	-0.3V to +4V	8-Pin SO (derate 5.88mW/°C above +70°C).....	471mW
IN <sub>-</sub> to GND .....	-0.3V to +3.9V	Operating Temperature Ranges	
OUT <sub>-</sub> to GND.....	-0.3V to (V <sub>CC</sub> + 0.3V)	MAX911_E .....	-40°C to +85°C
ESD Protection All Pins		Storage Temperature Range .....	-65°C to +150°C
(Human Body Model, IN <sub>+</sub> , IN <sub>-</sub> ) .....	±11kV	Lead Temperature (soldering, 10s) .....	+300°C
Continuous Power Dissipation (T <sub>A</sub> = +70°C)			
8-Pin SOT23 (derate 7.52mW/°C above +70°C).....	602mW		

Stresses beyond those listed under "Absolute Maximum Ratings" may cause permanent damage to the device. These are stress ratings only, and functional operation of the device at these or any other conditions beyond those indicated in the operational sections of the specifications is not implied. Exposure to absolute maximum rating conditions for extended periods may affect device reliability.

## ELECTRICAL CHARACTERISTICS

(V<sub>CC</sub> = +3.0V to +3.6V, magnitude of input voltage, |V<sub>ID</sub>| = +0.1V to +1.0V, V<sub>CM</sub> = |V<sub>ID</sub>|/2 to (2.4V - (|V<sub>ID</sub>|/2)), T<sub>A</sub> = -40°C to +85°C. Typical values are at V<sub>CC</sub> = +3.3V and T<sub>A</sub> = +25°C, unless otherwise noted.) (Notes 1, 2)

PARAMETER	SYMBOL	CONDITIONS	MIN	TYP	MAX	UNITS
Differential Input High Threshold (Note 3)	V <sub>TH</sub>	V <sub>CM</sub> = 0.05V, 1.2V, 2.75V at 3.3V			100	mV
Differential Input Low Threshold (Note 3)	V <sub>TL</sub>	V <sub>CM</sub> = 0.05V, 1.2V, 2.75V at 3.3V	-100			mV
Differential Input Resistance	R <sub>DIFF</sub>	V <sub>CM</sub> = 0.2V or 2.2V, V <sub>ID</sub> = ±0.4V, V <sub>CC</sub> = 0 or 3.6V	5	18		kΩ
Output High Voltage (OUT <sub>-</sub> )	V <sub>OH</sub>	I <sub>OH</sub> = -4mA	V <sub>ID</sub> = +200mV	2.7		V
			Inputs shorted, undriven	2.7		
			100Ω parallel termination, undriven	2.7		
Output Low Voltage (OUT <sub>-</sub> )	V <sub>OL</sub>	I <sub>OL</sub> = 4mA, V <sub>ID</sub> = -200mV			0.4	
Output Short-Circuit Current	I <sub>OS</sub>	V <sub>ID</sub> = +200mV, V <sub>OUT<sub>-</sub></sub> = 0			-100	mA
No-Load Supply Current	I <sub>CC</sub>	Inputs open	MAX9111	4.2	6	mA
			MAX9113	8.7	11	

# Single/Dual LVDS Line Receivers with Ultra-Low Pulse Skew in SOT23

MAX9111/MAX9113

## SWITCHING CHARACTERISTICS

(V<sub>CC</sub> = +3.0V to +3.6V, T<sub>A</sub> = -40°C to +85°C. Typical values are at V<sub>CC</sub> = +3.3V and T<sub>A</sub> = +25°C, unless otherwise noted.) (Notes 4, 5, 6)

PARAMETER	SYMBOL	CONDITIONS	MIN	TYP	MAX	UNITS
Differential Propagation Delay High to Low	t <sub>PHLD</sub>	C <sub>L</sub> = 15pF, V <sub>ID</sub> = ±200mV, V <sub>CM</sub> = 1.2V, Figures 1, 2	1	1.77	2.5	ns
Differential Propagation Delay Low to High	t <sub>PLHD</sub>		1	1.68	2.5	ns
Differential Pulse Skew  t <sub>PLHD</sub> - t <sub>PHLD</sub>   (Note 7)	t <sub>SKD1</sub>		90	300	ps	
Differential Channel-to-Channel Skew; Same Device (MAX9113 only) (Note 8)	t <sub>SKD2</sub>		140	400	ps	
Differential Part-to-Part Skew (Note 9)	t <sub>SKD3</sub>		1	ns		
Differential Part-to-Part Skew (MAX9113 only) (Note 10)	t <sub>SKD4</sub>		1.5	ns		
Rise Time	t <sub>TLH</sub>		0.6	0.8	ns	
Fall Time	t <sub>THL</sub>		0.6	0.8	ns	
Maximum Operating Frequency	f <sub>MAX</sub>	All channels switching, C <sub>L</sub> = 15pF, V <sub>OL</sub> (max) = 0.4V, V <sub>OH</sub> (min) = 2.7V, 40% < duty cycle < 60% (Note 6)	250	300	MHz	

- Note 1:** Maximum and minimum limits over temperature are guaranteed by design and characterization. Devices are production tested at T<sub>A</sub> = +25°C.
- Note 2:** Current into the device is defined as positive. Current out of the devices is defined as negative. All voltages are referenced to ground except V<sub>TH</sub> and V<sub>TL</sub>.
- Note 3:** Guaranteed by design, not production tested.
- Note 4:** AC parameters are guaranteed by design and characterization.
- Note 5:** C<sub>L</sub> includes probe and test jig capacitance.
- Note 6:** f<sub>MAX</sub> generator output conditions: t<sub>R</sub> = t<sub>F</sub> < 1ns (0% to 100%), 50% duty cycle, V<sub>OH</sub> = 1.3V, V<sub>OL</sub> = 1.1V.
- Note 7:** t<sub>SKD1</sub> is the magnitude difference of differential propagation delays in a channel. t<sub>SKD1</sub> = |t<sub>PLHD</sub> - t<sub>PHLD</sub>|.
- Note 8:** t<sub>SKD2</sub> is the magnitude difference of the t<sub>PLHD</sub> or t<sub>PHLD</sub> of one channel and the t<sub>PLHD</sub> or t<sub>PHLD</sub> of the other channel on the same device.
- Note 9:** t<sub>SKD3</sub> is the magnitude difference of any differential propagation delays between devices at the same V<sub>CC</sub> and within 5°C of each other.
- Note 10:** t<sub>SKD4</sub>, is the magnitude difference of any differential propagation delays between devices operating over the rated supply and temperature ranges.

# Single/Dual LVDS Line Receivers with Ultra-Low Pulse Skew in SOT23

## Test Circuit Diagrams

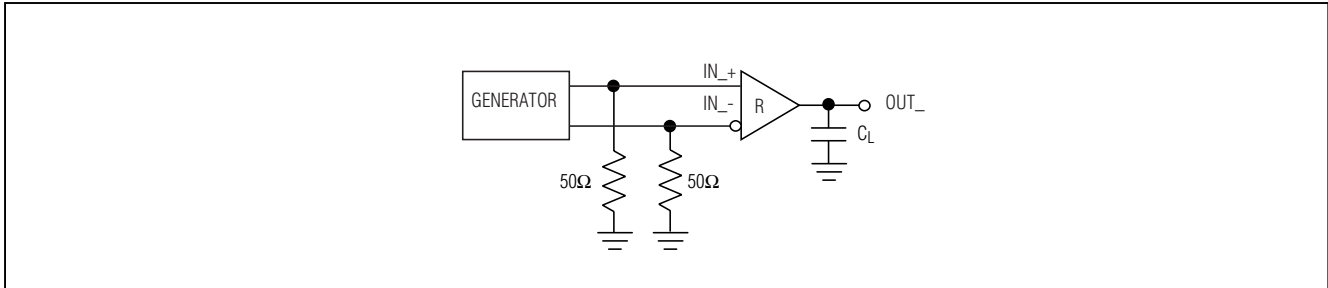

Figure 1. Receiver Propagation Delay and Transition Time Test Circuit

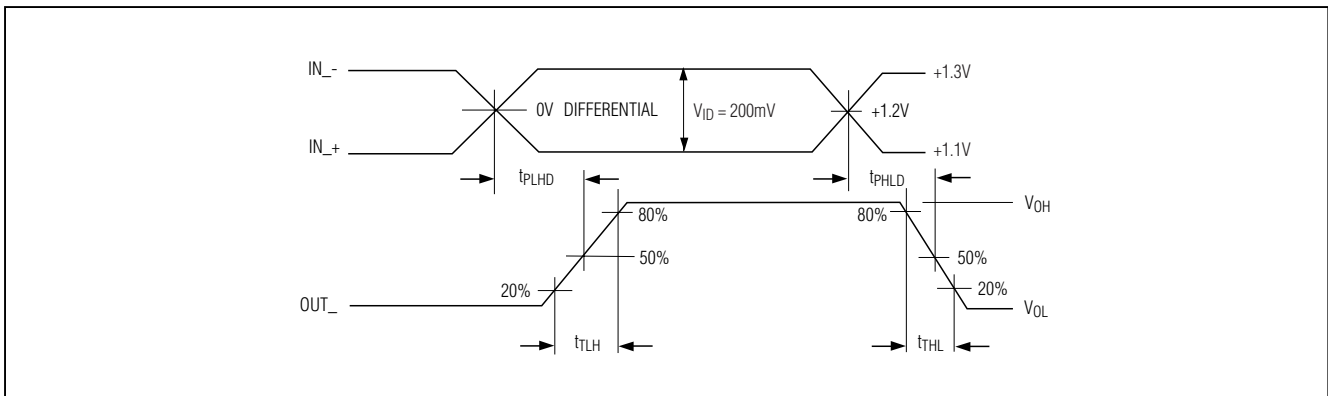

Figure 2. Receiver Propagation Delay and Transition Time Waveforms

# Single/Dual LVDS Line Receivers with Ultra-Low Pulse Skew in SOT23

## Typical Operating Characteristics

( $V_{CC} = 3.3V$ ,  $|V_{ID}| = 200mV$ ,  $V_{CM} = 1.2V$ ,  $f_{IN} = 200MHz$ ,  $C_L = 15pF$ ,  $T_A = +25^\circ C$  and over recommended operating conditions unless otherwise specified.)

MAX9111/MAX9113

**OUTPUT HIGH VOLTAGE vs. SUPPLY VOLTAGE**

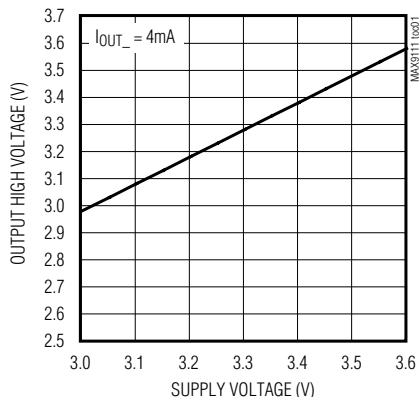

**OUTPUT LOW VOLTAGE vs. SUPPLY VOLTAGE**

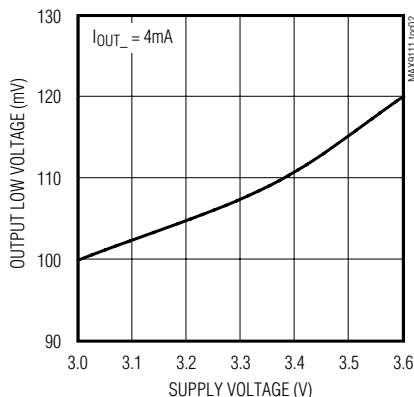

**OUTPUT SHORT-CIRCUIT CURRENT vs. SUPPLY VOLTAGE**

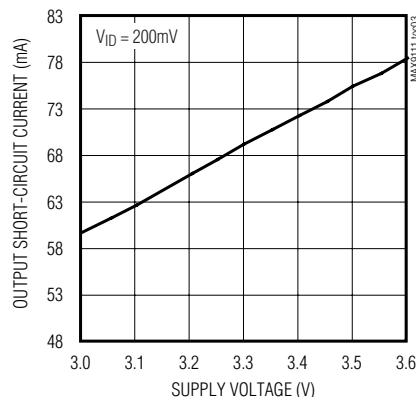

**DIFFERENTIAL THRESHOLD VOLTAGE vs. SUPPLY VOLTAGE**

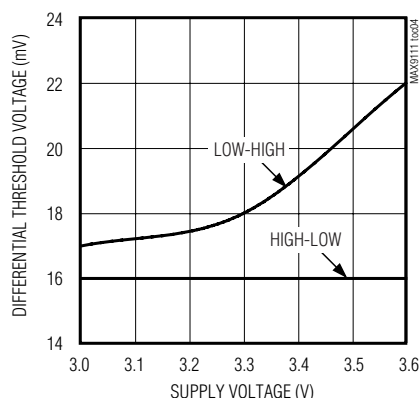

**MAX9113 POWER-SUPPLY CURRENT vs. FREQUENCY**

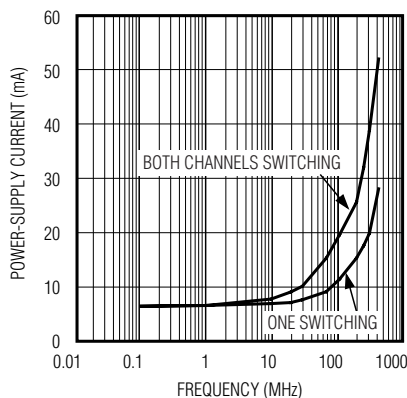

**POWER-SUPPLY CURRENT vs. TEMPERATURE**

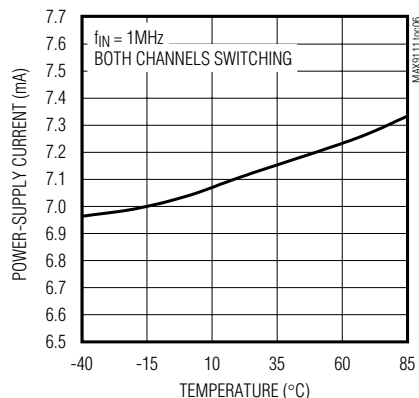

**DIFFERENTIAL PROPAGATION DELAY vs. SUPPLY VOLTAGE**

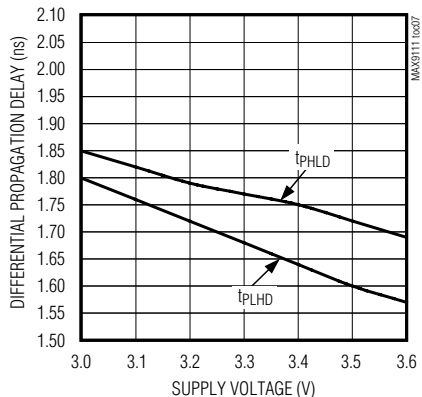

**DIFFERENTIAL PROPAGATION DELAY vs. TEMPERATURE**

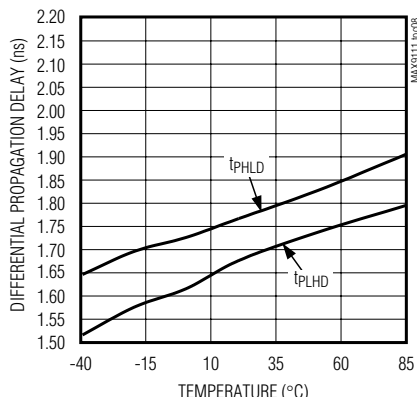

**DIFFERENTIAL PULSE SKEW vs. SUPPLY VOLTAGE**

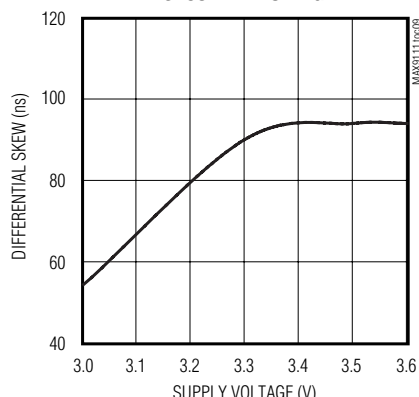

# Single/Dual LVDS Line Receivers with Ultra-Low Pulse Skew in SOT23

## Typical Operating Characteristics (continued)

( $V_{CC} = 3.3V$ ,  $|V_{ID}| = 200mV$ ,  $V_{CM} = 1.2V$ ,  $f_{IN} = 200MHz$ ,  $C_L = 15pF$ ,  $T_A = +25^\circ C$  and over recommended operating conditions, unless otherwise specified.)

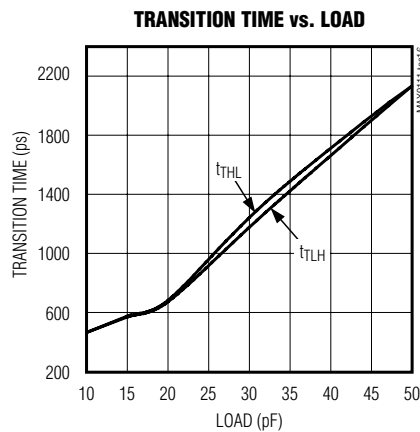
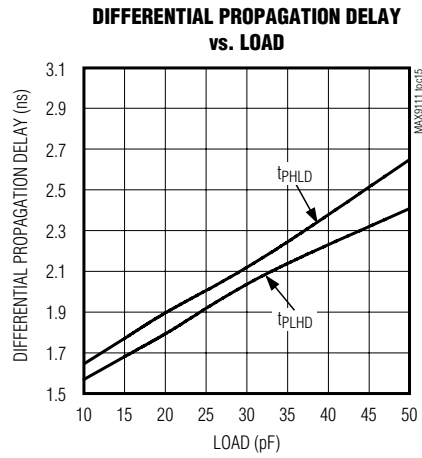
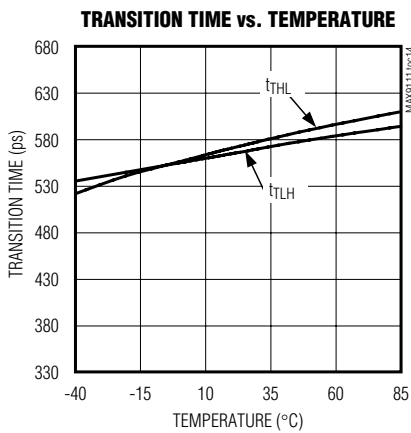
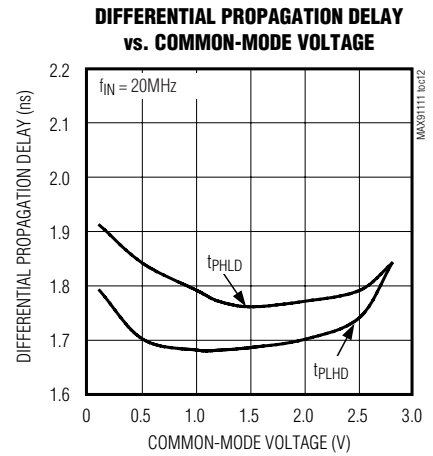
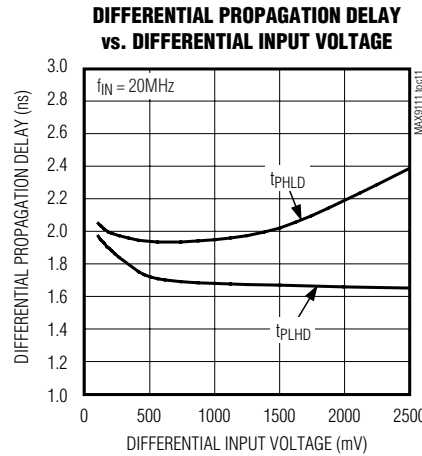
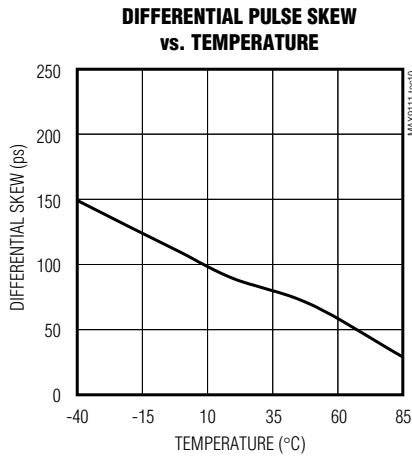

# Single/Dual LVDS Line Receivers with Ultra-Low Pulse Skew in SOT23

## Pin Description

MAX9111/MAX9113

PIN				NAME	FUNCTION
MAX9111		MAX9113			
SOT23-8	SO-8	SOT23-8	SO-8		
1	8	1	8	V <sub>CC</sub>	Power Supply
2	5	2	5	GND	Ground
8	1	8	1	IN-/IN1-	Receiver Inverting Differential Input
7	2	7	2	IN+/IN1+	Receiver Noninverting Differential Input
—	—	5	4	IN2-	Receiver Inverting Differential Input
—	—	6	3	IN2+	Receiver Noninverting Differential Input
3	7	3	7	OUT/OUT1	Receiver Output
—	—	4	6	OUT2	Receiver Output
4, 5, 6	3, 4, 6	—	—	N.C.	No Connection. Not internally connected.

## Detailed Description

### LVDS Inputs

The MAX9111/MAX9113 feature LVDS inputs for interfacing high-speed digital circuitry. The LVDS interface standard is a signaling method intended for point-to-point communication over a controlled impedance media, as defined by the ANSI/EIA/TIA-644 standards. The technology uses low-voltage signals to achieve fast transition times, minimize power dissipation, and noise immunity. Receivers such as the MAX9111/MAX9113 convert LVDS signals to CMOS/LVTTL signals at rates in excess of 500Mbps. The devices are capable of detecting differential signals as low as 100mV and as high as 1V within a 0V to 2.4V input voltage range. The LVDS standard specifies an input voltage range of 0 to 2.4V referenced to ground.

### Fail-Safe

The fail-safe feature sets the output to a high state when the inputs are undriven and open, terminated, or shorted. When using one channel in the MAX9113, leave the unused channel open.

### ESD Protection

As with all Maxim devices, ESD-protection structures are incorporated on all pins to protect against electrostatic discharges encountered during handling and assembly. The receiver inputs of the MAX9111/MAX9113 have extra protection against static electricity. Maxim's engineers have developed state-of-the-art structures to protect these pins against ESD of  $\pm 11$ kV without damage. The ESD structures withstand high ESD in all states: normal operation, shutdown, and powered down.

ESD protection can be tested in various ways; the receiver inputs of this product family are characterized for protection to the limit of  $\pm 11$ kV using the Human Body Model.

### Human Body Model

Figure 3a shows the Human Body Model, and Figure 3b shows the current waveform it generates when discharged into a low impedance. This model consists of a 100pF capacitor charged to the ESD voltage of interest, which is then discharged into the test device through a 1.5k $\Omega$  resistor.

# Single/Dual LVDS Line Receivers with Ultra-Low Pulse Skew in SOT23

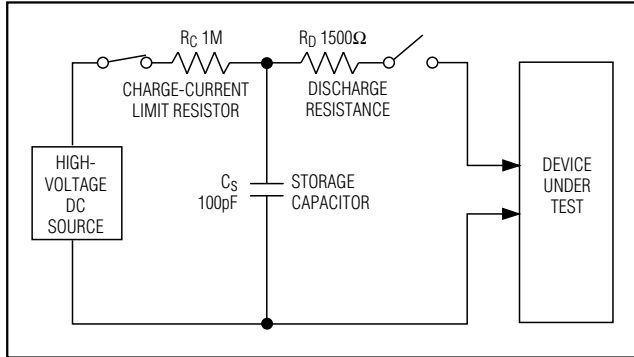

Figure 3a. Human Body ESD Test Modules

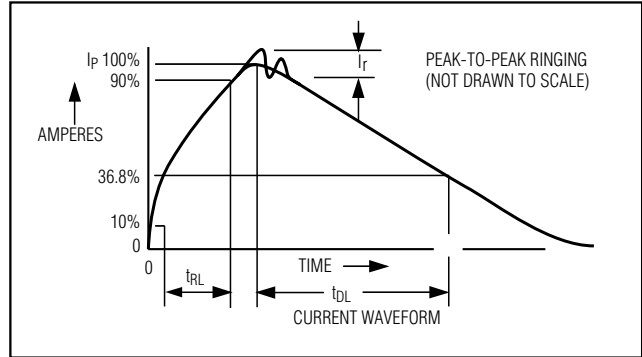

Figure 3b. Human Body Current Waveform

## Applications Information

### Supply Bypassing

Bypass  $V_{CC}$  with high-frequency surface-mount ceramic 0.1 $\mu F$  and 0.001 $\mu F$  capacitors in parallel, as close to the device as possible, with the 0.001 $\mu F$  valued capacitor the closest to the device. For additional supply bypassing, place a 10 $\mu F$  tantalum or ceramic capacitor at the point where power enters the circuit board.

### Differential Traces

Output trace characteristics affect the performance of the MAX9111/MAX9113. Use controlled impedance traces to match trace impedance to both transmission medium impedance and the termination resistor. Eliminate reflections and ensure that noise couples as common mode by running the differential traces close together. Reduce skew by matching the electrical length of the traces. Excessive skew can result in a degradation of magnetic field cancellation.

Maintain the distance between the differential traces to avoid discontinuities in differential impedance. Avoid 90° turns and minimize the number of vias to further prevent impedance discontinuities.

### Cables and Connectors

Transmission media should have a differential characteristic impedance of about 100 $\Omega$ . Use cables and connectors that have matched impedance to minimize impedance discontinuities.

Avoid the use of unbalanced cables such as ribbon or simple coaxial cable. Balanced cables such as twisted pair offer superior signal quality and tend to generate less EMI due to canceling effects. Balanced cables tend to pick up noise as common mode, which is rejected by the LVDS receiver.

### Termination

Termination resistors should match the differential characteristic impedance of the transmission line. Because the MAX9111/MAX9113 are current steering devices, an output voltage will not be generated without a termination resistor. Output voltage levels depend upon the value of the termination resistor. Resistance values may range from 75 $\Omega$  to 150 $\Omega$ .

Minimize the distance between the termination resistor and receiver inputs. Use a single 1% to 2% surface-mount resistor across the receiver inputs.

### Board Layout

For LVDS applications, a four-layer PC board that provides separate power, ground, LVDS signals, and input signals is recommended. Isolate the input and LVDS signals from each other to prevent coupling. For best results, separate the input and LVDS signal planes with the power and ground planes.



# Single/Dual LVDS Line Receivers with Ultra-Low Pulse Skew in SOT23

## Typical Operating Circuit

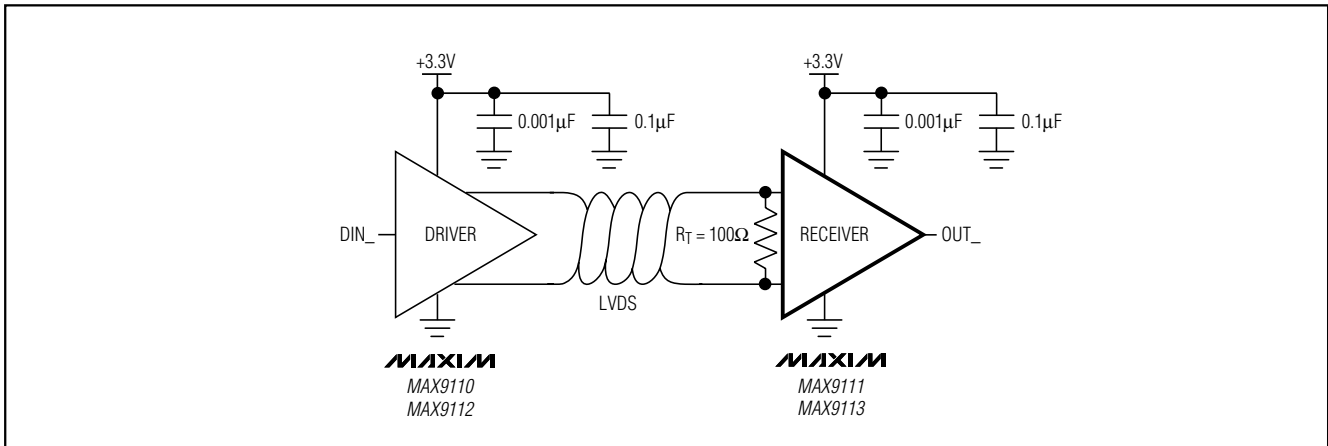

MAX9111/MAX9113

## Chip Information

TRANSISTOR COUNT:

MAX9111: 675

MAX9113: 675

PROCESS: CMOS

# Single/Dual LVDS Line Receivers with Ultra-Low Pulse Skew in SOT23

## Package Information

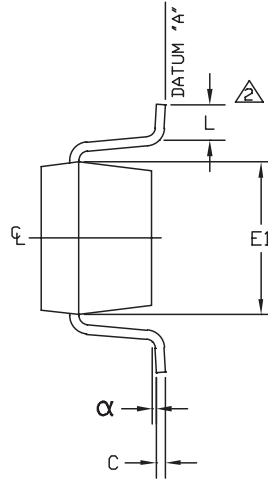
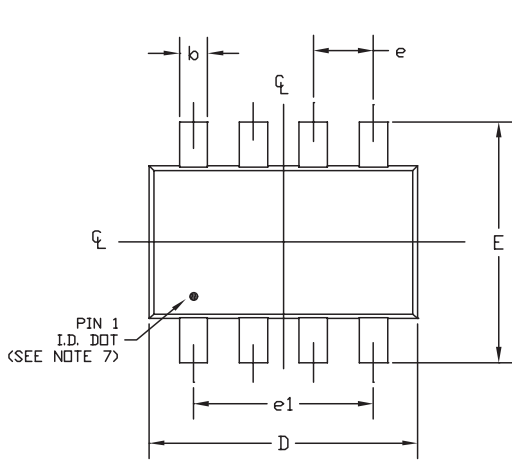

SYMBOL	MIN	MAX
A	0.90	1.45
A1	0.00	0.15
A2	0.90	1.30
b	0.28	0.45
C	0.09	0.20
D	2.80	3.00
E	2.60	3.00
E1	1.50	1.75
L	0.10	0.60
e	0.65 ref	
e1	1.95 ref	
$\alpha$	0°	10°

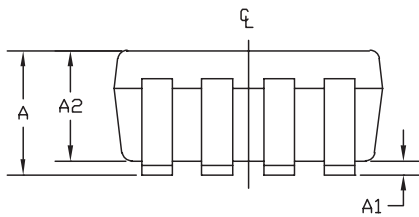

- NOTE:
1. ALL DIMENSIONS ARE IN MILLIMETERS.
  2.  $\triangle$  FOOT LENGTH MEASURED REFERENCE TO FLAT FOOT SURFACE PARALLEL TO DATUM "A".
  3. PACKAGE OUTLINE EXCLUSIVE OF MOLD FLASH & METAL BURR.
  4. PACKAGE OUTLINE INCLUSIVE OF SOLDER PLATING.
  5. EIAJ REF. NUMBER SC-74 (6 LEAD VERSION)
  6. COPLANARITY 4 MILS. MAX.
  7. PIN 1 I.D. DOT IS 0.3 MM  $\phi$  MIN. LOCATED ABOVE PIN 1.

**MAXIM**

PROPRIETARY INFORMATION

TITLE:  
PACKAGE OUTLINE, SOT 23, 8L

APPROVAL	DOCUMENT CONTROL NO. 21-0078	REV B	1/1
----------	---------------------------------	----------	-----

SOT23, 8LEPS

# Single/Dual LVDS Line Receivers with Ultra-Low Pulse Skew in SOT23

## Package Information (continued)

MAX9111/MAX9113

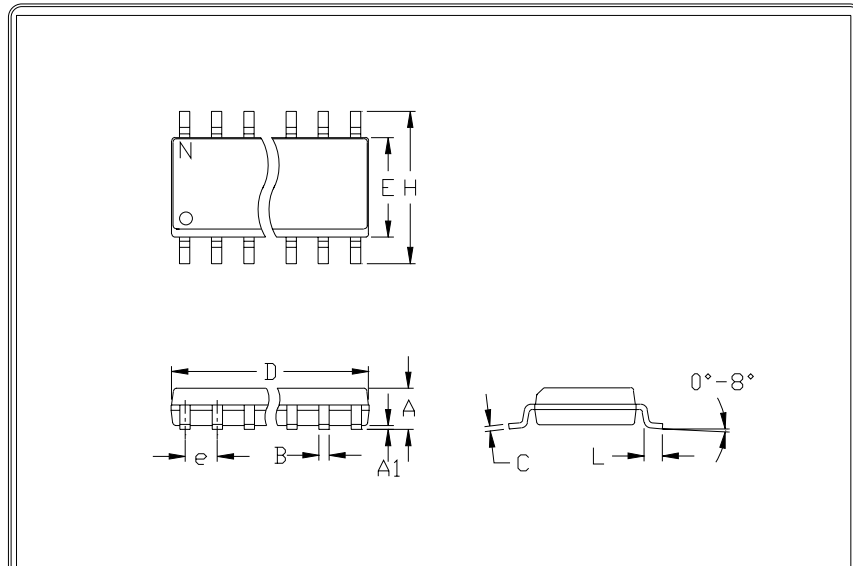

	INCHES		MILLIMETERS	
	MIN	MAX	MIN	MAX
A	0.053	0.069	1.35	1.75
A1	0.004	0.010	0.10	0.25
B	0.014	0.019	0.35	0.49
C	0.007	0.010	0.19	0.25
e	0.050		1.27	
E	0.150	0.157	3.80	4.00
H	0.228	0.244	5.80	6.20
h	0.010	0.020	0.25	0.50
L	0.016	0.050	0.40	1.27

	INCHES		MILLIMETERS		N	MS012
	MIN	MAX	MIN	MAX		
D	0.189	0.197	4.80	5.00	8	A
D	0.337	0.344	8.55	8.75	14	B
D	0.386	0.394	9.80	10.00	16	C

- NOTES:
1. D&E DO NOT INCLUDE MOLD FLASH
  2. MOLD FLASH OR PROTRUSIONS NOT TO EXCEED .15mm (.006")
  3. LEADS TO BE COPLANAR WITHIN .102mm (.004")
  4. CONTROLLING DIMENSION: MILLIMETER
  5. MEETS JEDEC MS012-XX AS SHOWN IN ABOVE TABLE
  6. N = NUMBER OF PINS



120 SAN GABRIEL DR. SAN JOSE, CA 94086. FAX (408) 737-7794  
PROPRIETARY INFORMATION

PACKAGE FAMILY OUTLINE: SOIC .150"

1/1

21-0041 A  
DOCUMENT CONTROL NUMBER REV

# **Single/Dual LVDS Line Receivers with Ultra-Low Pulse Skew in SOT23**

## **NOTES**

*Maxim cannot assume responsibility for use of any circuitry other than circuitry entirely embodied in a Maxim product. No circuit patent licenses are implied. Maxim reserves the right to change the circuitry and specifications without notice at any time.*

**12** \_\_\_\_\_ **Maxim Integrated Products, 120 San Gabriel Drive, Sunnyvale, CA 94086 408-737-7600**

This datasheet has been downloaded from:

[www.DatasheetCatalog.com](http://www.DatasheetCatalog.com)

Datasheets for electronic components.