

PRODUCT SPECIFICATION

DATE : 06/04/2012

cosmo ELECTRONICS CORPORATION	Photocoupler : K1010	NO.60P00075	REV.
		SHEET 1 OF 6	6

High Reliability Photocoupler

● Features

1. Current transfer ratio
(CTR : Min. 50% at $I_F=5\text{mA}$ $V_{CE}=5\text{V}$)
2. High isolation voltage between input and output
(Viso : 5000Vrms)
3. Compact dual-in-line package.
4. Pb free and RoHS compliant.
5. Agency Approvals
 - UL UL1577 / CUL C22.2 No.1 & NTC No.5, File No. E169586
 - VDE EN60747, File No.101347
 - FIMKO EN60065, File No.FI23149
 - FIMKO EN60950, File No.FI24584
 - SEMKO EN60065, File No.1016484
 - SEMKO EN60950, File No.1016433
 - CQC GB4943 / GB8898, File No.CQC10001049555/CQC08001023986

● Application :

1. Registers, copies, automatic vending machines.
2. System appliances, measuring instruments.
3. Computer terminals, programmable controllers.
4. Communications, telephone, etc.
5. Electric home appliances, such as oil fan heaters, Microwave Oven, Washer, Refrigerator, Air conditioner, etc.
6. Medical instruments, physical and chemical equipment.
7. Signal transmission between circuits of different potentials and impedances.
8. Facsimile equipment, Audio, Video.
9. Switching power supply, Laser beam printer.

PRODUCT SPECIFICATION

DATE : 06/04/2012

cosmo ELECTRONICS CORPORATION	Photocoupler : K1010	NO.60P00075	REV. 6
		SHEET 2 OF 6	

● Outside Dimension : Unit (mm)

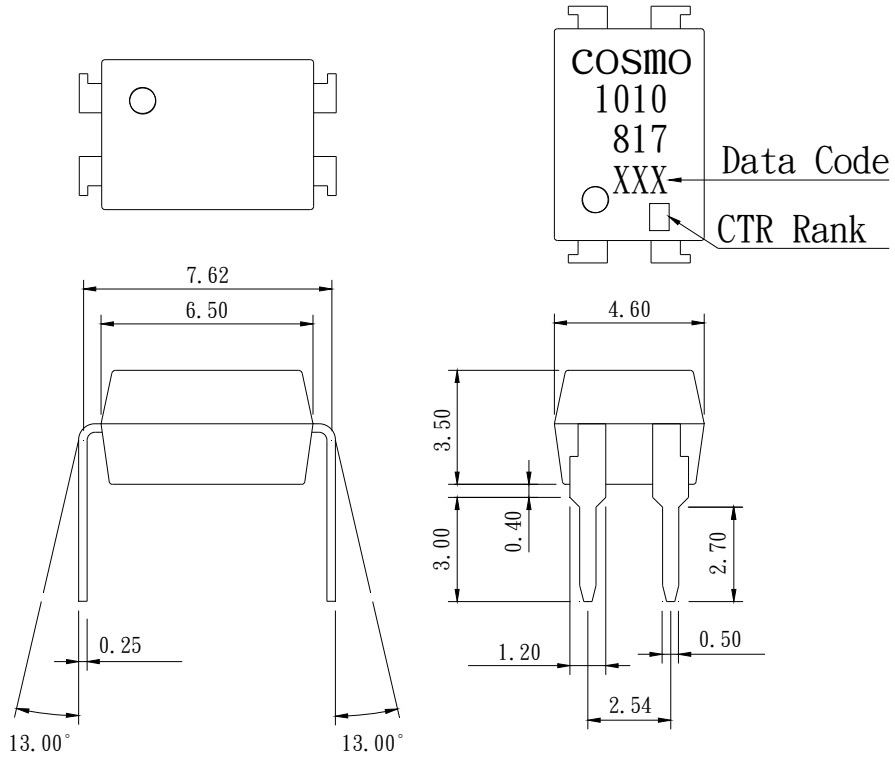

TOLERANCE : ±0.2mm

● Schematic : Top View

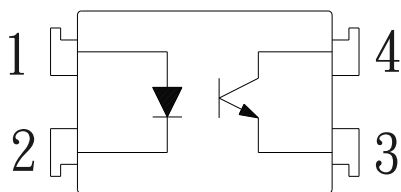

1. Anode
2. Cathode
3. Emitter
4. Collector

PRODUCT SPECIFICATION

DATE : 06/04/2012

cosmo ELECTRONICS CORPORATION	Photocoupler : K1010	NO.60P00075	REV.
		SHEET 3 OF 6	6

● Absolute Maximum Ratings

Parameter		Symbol	Rating	Unit
Input	Forward current	I_F	50	mA
	Peak forward current	I_{FM}	1	A
	Reverse voltage	V_R	6	V
	Power dissipation	P_D	70	mW
Output	Collector-emitter voltage	V_{CEO}	80	V
	Emitter-collector voltage	V_{ECO}	6	V
	Collector current	I_C	50	mA
	Collector power dissipation	P_C	150	mW
	Junction temperature	T_j	125	°C
Total power dissipation		P_{tot}	200	mW
Isolation voltage 1 minute		V_{iso}	5000	V _{rms}
Operating temperature		T_{opr}	-55 to +115	°C
Storage temperature		T_{stg}	-55 to +125	°C
Soldering temperature 10 second		T_{sol}	260	°C

● Electro-optical Characteristics

Parameter		Symbol	Conditions	MIN.	TYP.	MAX.	Unit
Input	Forward voltage	V_F	$I_F=20mA$	-	1.2	1.4	V
	Peak forward voltage	V_{FM}	$I_{FM}=0.5A$	-	-	3.0	V
	Reverse current	I_R	$V_R=4V$	-	-	10	μA
	Terminal capacitance	C_t	$V=0, f=1KHz$	-	30	-	pF
Output	Collector dark current	I_{CEO}	$V_{CE}=20V$	-	-	0.1	μA
Transfer characteristics	Current transfer ratio	CTR	$I_F=5mA, V_{CE}=5V$	50	-	600	%
	Collector-emitter saturation	$V_{CE(sat)}$	$I_F=20mA, I_C=1mA$	-	0.1	0.2	V
	Isolation resistance	R_{iso}	DC500V	5×10^{10}	10^{11}	-	Ω
	Floating capacitance	C_f	$V=0, f=1MHz$	-	0.6	1.0	pF
	Cut-off frequency	f_C	$V_{CC}=5V, I_C=2mA, R_L=100\Omega$	-	80	-	KHz
	Response time (Rise)	t_r	$V_{CE}=2V, I_C=2mA, R_L=100\Omega$	-	4	18	μs
	Response time (Fall)	t_f		-	3	18	μs

PRODUCT SPECIFICATION

DATE : 06/04/2012

cosmo ELECTRONICS CORPORATION	Photocoupler :	NO.60P00075	REV.
	K1010	SHEET 4 OF 6	6

Classification table of current transfer ratio is shown below.

Model No.	CTR (%)
K10101A	80 ~ 160
K10101B	130 ~ 260
K10101C	200 ~ 400
K10101D	300 ~ 600
K10101E	50 ~ 600

Fig.1 Current Transfer Ratio vs. Forward Current

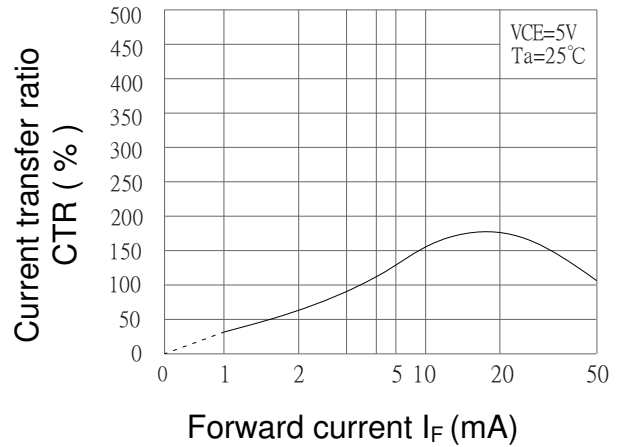

Fig.2 Collector Power Dissipation vs. Ambient Temperature

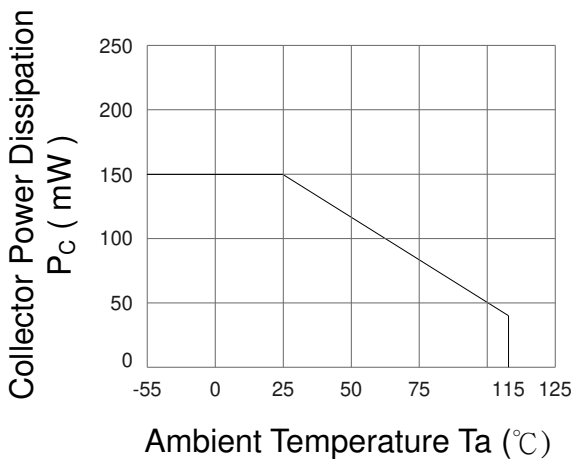

Fig.3 Collector Dark Current vs. Ambient Temperature

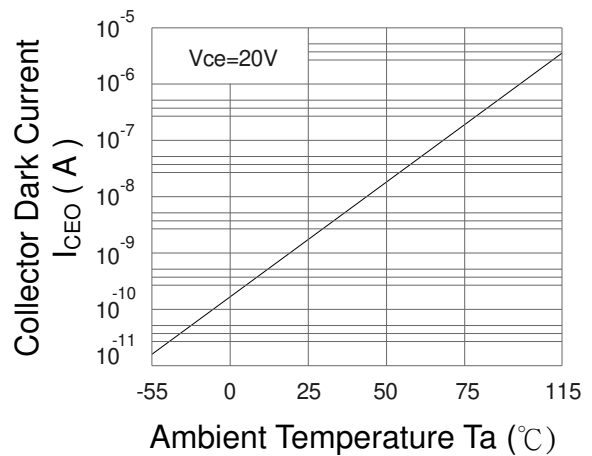

Fig.4 Forward Current vs. Ambient Temperature

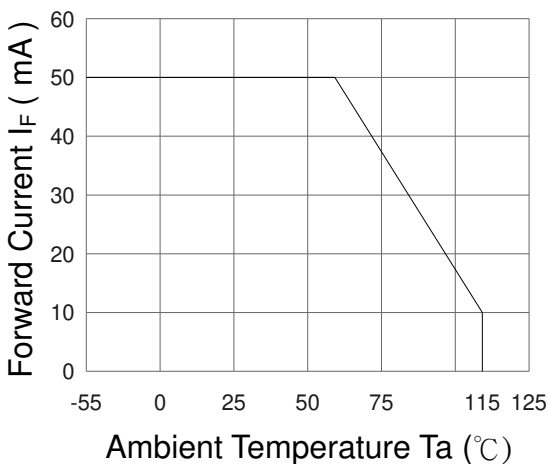
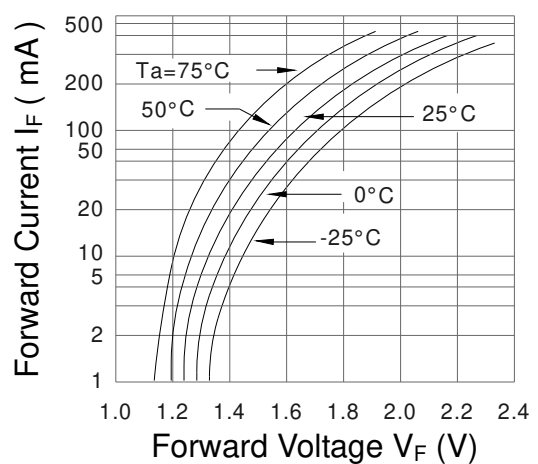

Fig.5 Forward Current vs. Forward Voltage



PRODUCT SPECIFICATION

DATE : 06/04/2012

cosmo
ELECTRONICS CORPORATION

Photocoupler :
K1010

NO.60P00075
SHEET 5 OF 6

REV.
6

Fig.6 Collector Current vs. Collector-Emitter Voltage

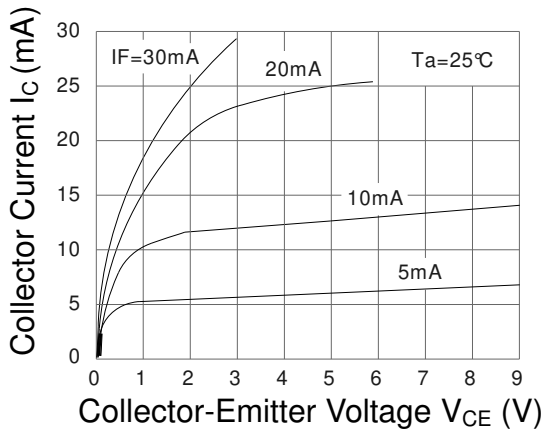

Fig.7 Relative Current Transfer Ratio vs. Ambient Temperature

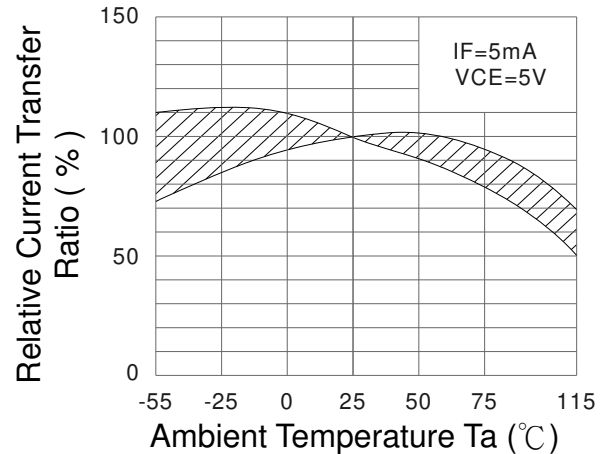

Fig.8 Collector-Emitter Saturation Voltage vs. Ambient Temperature

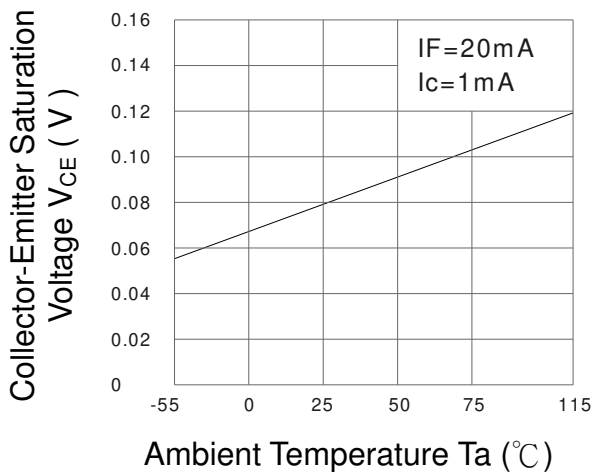

Fig.9 Collector-Emitter Saturation Voltage vs. Forward Current

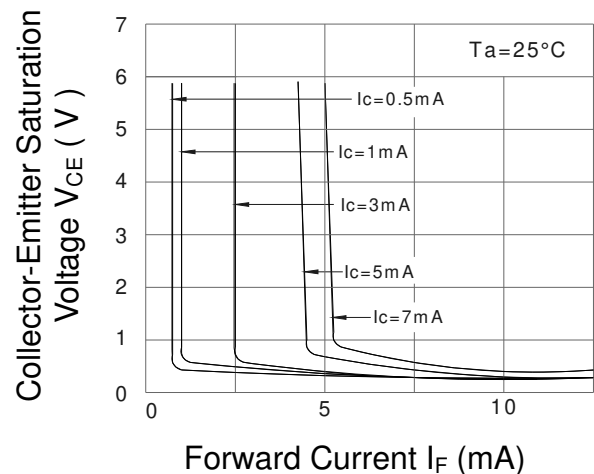

Fig.10 Response Time vs. Load Resistance

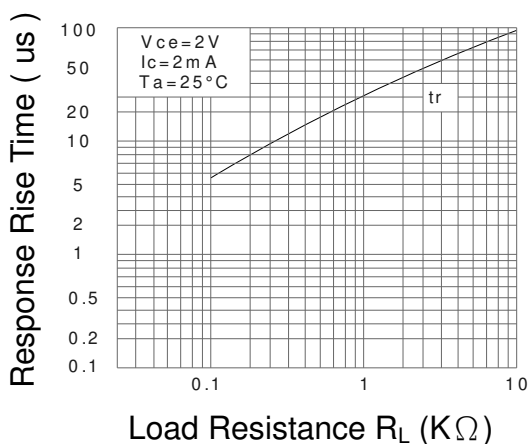
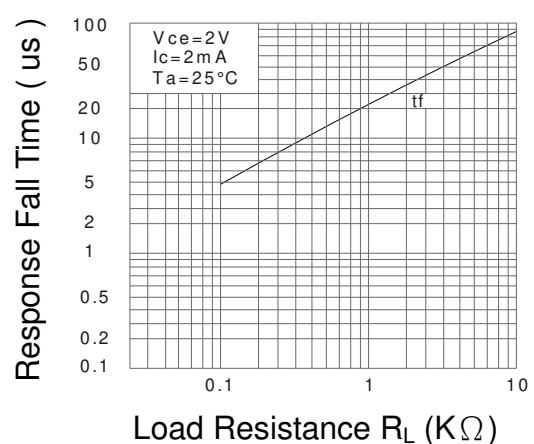

Fig.11 Response Time vs. Load Resistance



PRODUCT SPECIFICATION

DATE : 06/04/2012

cosmo ELECTRONICS CORPORATION	Photocoupler : K1010	NO.60P00075	REV.
		SHEET 6 OF 6	6

● Notice

The information contained in this document is intended to be a general product description and is subject to change without notice. Please contact cosmo in order to obtain the latest device data sheets before using any cosmo device. cosmo does not assume any responsibility for use of any circuitry described. No circuit patent licenses are implied. This publication is the property of cosmo. No part of this publication may be reproduced or copied in any form or by any means, or transferred to any third party without the prior written consent of cosmo Electronics Corporation.

The devices listed in this document are designed for general applications only in electronic equipment. No devices shall be deployed which require higher level of reliability such as :

- Medical and other life support equipments.
- Space application.
- Telecommunication equipment (trunk lines).
- Nuclear power control equipment.

Unless it received prior written approval from cosmo.

cosmo takes no responsibility for damages arise form the improper usage of our device. Please contact cosmo for further information regarding the above notices.