

THE CRYSTALMASTER

PRODUCT CATALOG

•
May 2005



ENERGY SAVING EPSON

EPSON offers effective savings to its customers through a wide range of electronic devices, such as semiconductors, liquid crystal display (LCD) modules, and crystal devices. These savings are achieved through a sophisticated melding of three different efficiency technologies.

Power saving technology provides low power consumption at low voltages.

Space saving technology provides further reductions in product size and weight through super-precise processing and high-density assembly technology.

Time saving technology shortens the time required for design and development on the customer side and shortens delivery times.

Our concept of Energy Saving technology conserves resources

by blending the essence of these three efficiency technologies. The essence of these technologies is represented in each of the products that we provide to our customers.

In the industrial sector, leading priorities include measures to counter greenhouse effect by reducing CO₂, measures to preserve the global environment, and the development of energy-efficient products. Environmental problems are of global concern, and although the contribution of energy-saving products by our customers through the utilization of our electronic devices, EPSON is committed to the conservation of energy, both for the sake of people and of the planet on which we live.

WORKING WITH ENVIRONMENTAL ISSUES

In 1988, Seiko Epson led in working to abolish CFCs, and the abolition of those ozone layer-destroying substances was achieved in 1992. In 1998, the 10th year of start of the CFC-free activity, Seiko Epson set this year as the "Second Environmental Benchmark Year" and established a new corporate General Environment Policy. Seiko Epson is tackling with environmental issues comprehensively.

At the end of Fiscal 1988, Seiko Epson succeeded in abolishing chloric solvents doubted to be harmful to human body. In fiscal 1999, Seiko Epson started the activity with a goal of abolishing lead solder. Pointed out possibility of environmental pollutant.



Co-existence Mark

The environmental mark symbolizing Epson's basic stance of "Co-existence With Nature". The design incorporates a fish, flower, and water, representing mutually supportive co-existence.

PROMOTION OF ENVIRONMENT MANAGEMENT SYSTEM CONFORMING INTERNATIONAL STANDARD

At Epson, all environmental initiatives operate under the Plan-Do-Check-Action (PDCA) cycle designed to achieve continuous improvements.

The environmental management system (EMS) operates under the ISO 14001 environmental management standard.

In May 2001, all of our major manufacturing and non-manufacturing sites, in Japan and overseas, completed the acquisition of ISO 14001 certification.

In the future, new Group companies will be expected to acquire the certification around the third year of operations.



ISO14000 is an international standard for environmental management that was established by the International Standards Organization in 1996 against the background of growing concern regarding global warming, destruction of the ozone layer, and global deforestation.

WORKING FOR HIGH QUALITY

Seiko-Epson quickly began working to acquire company-wide ISO9000 series certification, and has acquired ISO9001 or ISO 9002 certification with all targeted products manufactured in Japanese and overseas plants.

The Quartz Device Operations Division (Ina Japan, EPM and SZE) have acquired QS-9000 certification, which are of higher Level.



QS-9000 is an enhanced standard for quality assurance systems formulated by leading U.S. automobile manufacturers based on the international ISO 9000 series.

Notice

- The material is subject to change without notice.
- Any part of this material may not be reproduced or duplicated in any form or any means without the written permission of Seiko Epson.
- The information, applied circuit, program, usage etc., written in this material is just for reference. Seiko Epson does not assume any liability for the occurrence of infringing any patent or copyright of third party. This material does not authorize the licence for any patent or intellectual copy rights.
- Any product described in this material may contain technology or the subject relating to strategic products under the control of the Foreign Exchange and Foreign Trade Law of Japan and may require an export licence from the Ministry of International Trade and industry or other approval from another government agency.
- The products (except for some product for automotive applications) listed in this catalog are designed to be used with ordinary electronic equipment(OA equipment, AV equipment, communications equipment, measuring instruments etc).

Seiko Epson does not assume any liability in case of products used in applications requiring high reliability or extreme safety conditions (such as aerospace equipment etc). When intending to use any of our products in automotive applications or applications other than ordinary electronic equipments as above, please contact our sales representatives in advance.

CONTENTS

APPLICATION GUIDE

•WORKING FOR Pb FREE PRODUCTS	1 ~ 2
•FREQUENCY RANGE LIST	3 ~ 4
•PACKAGE DIMENSIONS LIST	5 ~ 6
•HANDLING PRECAUTIONS	7 ~ 9
•PRECAUTIONS IN DESIGNING OSCILLATION CIRCUITS	10 ~ 11
•OUTPUT WAVE FORM AND TEST CIRCUIT	11
•QUARTZ DEVICE FOR AUTOMOTIVE	12

CRYSTAL UNIT/RESONATOR

•TUNING FORK CRYSTAL UNITS (kHz range)	13 ~ 17
•AT CRYSTAL UNIT (MHz range)	18 ~ 23
•SAW RESONATOR (under GHz)	24 ~ 25

CRYSTAL OSCILLATOR

•NORMAL	26 ~ 34
•PROGRAMMABLE	35 ~ 39
SG-8002 SERIES SPECIFICATIONS LIST	40
SG-8002 SERIES CHARACTERISTICS CHART	41
SG-8002 SERIES PROGRAMMING TOOL	42
•SPREAD SPECTRUM	43
•LOW JITTER (SAW)	44 ~ 48
•HIGH-STABILITY	49 ~ 50
•MULTI-OUTPUT	51 ~ 52
•VCXO	53 ~ 56
•TCXO	57 ~ 58

REAL TIME CLOCK MODULE

•SERIAL INTERFACE	59 ~ 71
•PARALLEL INTERFACE	72 ~ 74

FILTER

•SAW FILTER	75 ~ 77
-------------------	---------































SENSOR

•GYRO SENSOR	78
•TEMPERATURE SENSING CRYSTAL	79





























STANDARD PACKING · etc

•STANDARD PACKING SPECIFICATIONS	80 ~ 81
•HOW TO ORDER AND PRODUCT NUMBER	82 ~ 84
•GLOSSARY	85 ~ 87















CRYSTAL UNIT/RESONATOR

Category	Model	Actual size (mm) Typ.	Frequency range	Page.		
Tuning fork Crystal units (kHz range)	FC-135		3.2×1.5×0.8t	32.768 kHz, 32 kHz to 77.5 kHz	13	
	FC-145		4.1×1.5×0.8t	32.768 kHz		
	FC-255		4.9×1.8×0.8t	32.768 kHz, 32 kHz to 100 kHz		
	MC-146		7.0×1.5×1.4t (Max.)	32.768 kHz, 32 kHz to 100 kHz	14	
	MC-156		7.1×3.3×1.5t (Max.)	32.768 kHz, 32 kHz to 100 kHz		
	MC-306		8.0×3.8×2.54t (Max.)	32.768 kHz, 20 kHz to 165 kHz	15	
	MC-405/406		10.41×4.06×3.6t (Max.)	32.768 kHz, 20 kHz to 165 kHz, 307.2 kHz		
	MC-30A	 <small>For Automotive</small>		8.0×3.8×2.54t (Max.)	32.768 kHz, 20 kHz to 165 kHz	16
	C-TYPE				17	
	C-001R		Φ3.1 Max.	32.768 kHz		
	C-002RX		Φ2.0 Max.			
	C-004R		Φ1.5 Max.			
C-005R		Φ1.2 Max.				
C-2-TYPE		Φ2.0 Max.	20 kHz to 165 kHz, 307.2 kHz			
C-4-TYPE		Φ1.5 Max.	32 kHz to 120 kHz, 192 kHz			
AT cut Crystal units (MHz range)	FA-238/238V		3.2×2.5×0.6t	12 MHz to 50 MHz	18	
	FA-23H (High-stability)		3.2×2.5×0.6t	16 MHz to 32 MHz	19	
	FA-365		6.0×3.5×1.4t	12 MHz, 14 MHz to 41 MHz	20	
	MA-306		8.0×3.8×2.54t (Max.)	14.31818 MHz, 17.734 MHz to 41 MHz	21	
	MA-406		11.7×4.8×3.7t (Max.)	4 MHz to 64 MHz	22	
	MA-505/506		13.46×5.08×4.6t (Max.)	4 MHz to 64 MHz		
	CA-301		Φ3.1 Max.	4 MHz to 64 MHz	23	
SAW Resonator (under GHz)	NS-32R	 <small>For Automotive</small>		3.8×3.8×0.98t	312 MHz to 870 MHz	24
	FS-335	 <small>For Automotive</small>		3.8×3.8×0.98t	300 MHz to 870 MHz	
	FS-555	 <small>For Automotive</small>		4.8×5.2×1.5t	230 MHz to 500 MHz	25
	FS-585	 <small>For Automotive</small>		4.8×5.2×1.5t	300 MHz to 500 MHz	







CRYSTAL OSCILLATOR

Category	Model	Actual size (mm) Typ.	Frequency range	Page.	
Normal	SG-3030JC SG-3040JC SG-3032JC		10.5×5.8×2.7t (Max.)	32.768 kHz	26
	SG-3030JF		7.1×5.1×1.5t (Max.)	32.768 kHz	
	SG-3030LC SG-3040LC		3.6×2.8×1.1t	32.768 kHz	
	SG-310 Series		3.2×2.5×1.05t	2 MHz to 48 MHz	27
	SG-350 Series		3.3×2.6×1.15t	1 MHz to 48 MHz	28
	SG-550 Series		5.0×3.2×1.2t (Max.)	1 MHz to 48 MHz	
	SG-710 Series		7.3×4.8×1.3t	1.8 MHz to 125 MHz	29
	SG-645 Series		7.1×5.1×1.5t (Max.)	32.001 MHz to 135 MHz	30
	SG-636 Series		10.5×5.8×2.7t (Max.)	2.21675 MHz to 135 MHz	31~32
	SG-615 Series		14.0×9.8×4.7t (Max.)	1.025 MHz to 135 MHz	33~34
	SG-531 Series		DIP half size	1.025 MHz to 135 MHz	
	SG-51 Series		DIP full size	1.025 MHz to 66.667 MHz	
Programmable	SG-8002CE Series		3.2×2.5×1.05t	1 MHz to 125 MHz	35
	SG-8002LA Series		3.3×2.6×1.15t	1 MHz to 125 MHz	36
	SG-8002LB Series		5.0×3.2×1.2t(Max.)	1 MHz to 125 MHz	
	SG-8002JF Series		7.1×5.1×1.5t (Max.)	1 MHz to 125 MHz	37
	SG-8002CA Series		7.0×5.0×1.4t	1 MHz to 125 MHz	
	SG-8002JC Series		10.5×5.8×2.7t (Max.)	1 MHz to 125 MHz	
	SG-8002JA Series		14.0×9.8×4.7t (Max.)	1 MHz to 125 MHz	38
	SG-8002DC Series		DIP half size	1 MHz to 125 MHz	39
	SG-8002DB Series		DIP full size	1 MHz to 125 MHz	
Spread Spectrum	SG-9001LB		5.0×3.2×1.2t(Max.)	10 MHz to 135 MHz	43
	SG-9001JC		10.5×5.8×2.7t (Max.)	10 MHz to 166 MHz	
	SG-9001CA		7.0×5.0×1.4t	10 MHz to 166 MHz	
High-stability	HG-2150CA		7.0×5.0×1.5t(Max.)	1 MHz to 80 MHz	49
	HG-8002JA Series		14.0×9.8×4.7t (Max.)	1 MHz to 125 MHz	50
Multi-output	MG-5020JE		7.0×6.0×1.5t (Max.)	32.768 kHz and 48.00512 MHz	51
	MG-5100SA		10.1×7.4×3.2t	76.9 kHz to 100 MHz	52



CRYSTAL OSCILLATOR

Category	Model	Actual size (mm) Typ.	Frequency range	Page.
Low jitter SAW	XG-1000CA	 7.0×5.0×1.2t	50 MHz to 170 MHz	44
	XG-1000CB	 5.0×3.2×1.1t	50 MHz to 170 MHz	
	EG-2011CA (1.8 V CMOS)	 7.0×5.0×1.2t	62.5 MHz to 170 MHz	45
	EG-2021CA (2.5 V CMOS)	 7.0×5.0×1.2t	62.5 MHz to 170 MHz	
	EG-2001CA (3.3 V CMOS)	 7.0×5.0×1.2t	106.25 MHz to 170 MHz	
	EG-2002CA (3.3 V LV-TTL)	 7.0×5.0×1.2t	62.5 MHz to 170 MHz	46
	EG-2121CA (2.5 V LV-PECL/LVDS)	 7.0×5.0×1.2t	53.125 MHz to 500 MHz LV-PECL 53.125 MHz to 700 MHz LVDS	47
	EG-2102CA (3.3 V LV-PECL/LVDS)	 7.0×5.0×1.2t	100 MHz to 700 MHz LV-PECL 53.125 MHz to 700 MHz LVDS	
	EG-2101CA (3.3 V Differential LV-PECL)	 7.0×5.0×1.2t	62.5 MHz to 400 MHz	48
VCXO	VG-4231CA	 7.0×5.0×1.4t	1 MHz to 75 MHz	53
	VG-1201CA	 7.0×5.0×1.4t	1 MHz to 80 MHz	54
	VG-4030JA	 14.0×9.8×4.7t (Max.)	2 MHz to 28.6363 MHz	55
	VG-2828CB	 5.0×3.2×1.2t	13 MHz	56
TCXO	TG-3530SA	 10.1×7.4×3.2t	32.768 kHz	57
	TG-5001LA	 3.3×2.6×1.15t	13 MHz to 40 MHz	58



























FILTER

Category	Model	Actual size (mm) Typ.	Frequency range	Page.
SAW FILTER	FF-32N 	 3.8×3.8×0.98t	310 MHz to 435 MHz	75
	FF-555 	 4.8×5.2×1.5t	300 MHz to 500 MHz	76
	FF-585 	 4.8×5.2×1.5t	300 MHz to 500 MHz	77

SENSOR

Category	Model	Actual size (mm) Typ.	Page.
Gyro Sensor	XV-3500CB	 5.0×3.2×1.3t	78
Temperature Sensing Crystal	HTS-206	 Φ 2.0 Max.	79

REAL TIME CLOCK MODULE

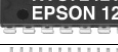
Category	Model	Actual size (mm) Typ.	Page.
Serial 4-Wire	RX-4045SA	 10.1×7.4×3.2t	59
	RX-4045NB	 6.3×5.2×1.4t (Max.)	
	RX-4581NB	 6.3×5.2×1.4t (Max.)	60
	RTC-9701JE	 7.3×6.2×1.5t (Max.)	61
Serial 3-Wire	RTC-4701JE	 7.3×6.2×1.5t (Max.)	62
	RTC-4701NB	 6.3×5.2×1.4t (Max.)	
	RTC-4574SA	 10.1×7.4×3.2t	63
	RTC-4574JE	 7.3×6.2×1.5t (Max.)	
	RTC-4574NB	 6.3×5.2×1.4t (Max.)	
	RX-4574LC	 3.6×2.4×1.2t (Max.)	
	RA-4574SA	 10.1×7.4×3.2t	65
	RTC-4543SA	 10.1×7.4×3.2t	66
	RTC-4543SB	 11.6×8.0×2.0t (Max.)	
	I ² C Bus	RX-8025SA	 10.1×7.4×3.2t
RX-8025NB		 6.3×5.2×1.4t (Max.)	
RTC-8564JE		 7.3×6.2×1.5t (Max.)	68
RTC-8564NB		 6.3×5.2×1.4t (Max.)	
RX-8564LC		 3.6×2.4×1.2t (Max.)	69
RX-8581SA		 10.1×7.4×3.2t	70
RX-8581JE		 7.3×6.2×1.5t (Max.)	
RX-8581NB		 6.3×5.2×1.4t (Max.)	
RA-8581SA		 10.1×7.4×3.2t	71
Parallel 4-bit	RTC-7301SF	 10.5×8.1×2.0t (Max.)	72
	RTC-7301DG	 DIP 18 pin	
	RTC-62421	 DIP 18 pin	73
	RTC-62423	 16.3×12.2×2.8t (Max.)	
	RTC-72421	 DIP 18 pin	74
	RTC-72423	 16.3×12.2×2.8t (Max.)	

WORKING FOR Pb FREE

■Pb Free Policy of QD products and Implementation Schedule

●Implementation Schedule

1. An announcement to our customers was made in June, 2001.
2. Epson started to manufacture Pb free products in April, 2002
3. For the products in mass production now, Epson will switch to Pb Free Products with customer's approval.
4. When ordering, please specify if Non-Pb Free products are desired.
Pb free products are Epson's standard.

● Eliminated Pb

〈 Basic policy 〉

“ Lead in solder “ means Soldering- paste for electronic circuit board & Solder Plating on the outer-lead of products.

●Cylinder type products (complete Pb free products)

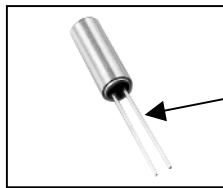

Pb used in these products is eliminated.

●Plastic package type products (Pb free terminal products)*1



Pb used as Solder-plating is eliminated

*1. These products are using Pb in high melting temperature type solders exempted by RoHS directive. These products include Pb inside.

●Current Pb free terminal products *2



●Current complete Pb free products *3



*2. Some ceramic package products are already Pb-free terminal type of product, but contain Pb in sealing glass exempted by RoHS. directive.

*3. Ceramic package products with metallic lid are already complete Lead-free type of product.

■DISTINCTIONS

●Distinctions between current products and Pb free products. *1

1) Product Number

The 9th position character of product number will change as follows. 〈Current = 0〉,〈 Pb free = 1 〉

Current	Qxxxxxxx0xxxx00
Pb free	Qxxxxxxx1xxxx00

2) Appearance

●Plastic package type products.

Marking (year part lot No.) will be changed as follows.

Current	Numeric	1	2	3	4	5	6	7	8	9	0
Pb free	Alphabet	A	B	C	D	E	F	G	H	J	K

●Cylinder type products

The glass color of plug will be changed as follows.

Current	Blue or Green etc
Pb free	Gray

〈 Exception 〉

*1 Ceramic package type products are originally Pb free terminal designed. So, there are no change as 1) and 2) above.

■ Pb Free materials of QD products

When ordering, please specify if Non-Pb Free products are desired.

	Model	Terminal Material	Terminal Plating	Complete lead Free	Location of Pb
Tuning fork Crystal units	C-xxxx Series	Fe-Ni-Co	Sn-Cu	○	
	FC-xxx Series	W	Au		sealing glass
	MC-xxx Series	42Alloy	Sn-Bi		Inside Crystal unit
AT-cut Crystal units	CA-301	Fe-Ni-Co	Sn-Cu	○	
	FA-238V / 238 / 23H	W	Au	○	
	FA-365	W	Au		sealing glass
Resonator	MA-xxx Series	42Alloy	Sn-Bi		Inside Crystal unit
	NS-xxx Series	W	Au	○	
Crystal Oscillator	FS-xxx Series	W	Au	○	
	SG-350 Series	42Alloy	Sn-Bi	○	
	SG-550 Series	42Alloy	Sn-Bi	○	
	SG-310 Series	W	Au	○	
	SG-645 Series	42Alloy	Sn-Bi		Inside Crystal unit
	SG-710 Series	W	Au	○	
	SG-636 Series	42Alloy	Sn-Bi		Inside Crystal unit
	SG-615 Series	42Alloy	Sn-Bi		Inside Crystal unit
	SG-51/531 Series	42Alloy	Sn-Bi		Inside Crystal unit
	SG-xxxx LA Series	42Alloy	Sn-Bi	○	
	SG-xxxxLB Series	42Alloy	Sn-Bi	○	
	SG-xxxxCE Series	W	Au	○	
	SG-xxxxJF Series	42Alloy	Sn-Bi		Inside Crystal unit
	SG-xxxxLC Series	42Alloy	Sn-Ag		Inside Crystal unit
	SG-xxxxCA Series				
	HG-xxxxCA Series	W	Au	○	
	VG-xxxxCA Series				
	XG-xxxxCA / CB Series	W	Au	○	
	EG-xxxxCA Series	W	Au	○	
	SG-xxxxJC Series	42Alloy	Sn-Bi		Inside Crystal unit
	SG / HG / VG-xxxxJA Series	42Alloy	Sn-Bi		Inside Crystal unit
	VG-xxxxCB Series	W	Au	○	
	TG-xxxxLA Series	42Alloy	Sn-Bi	○	
MG-5020JE	42Alloy	Sn-Ag		Inside Crystal unit	
MG-5100SA	42Alloy	Sn-Ag		Inside Crystal unit	
Real Time Clock Module	RX / RTC-xxxxSA Series	42Alloy	Sn-Ag		Inside Crystal unit
	RX / RTC-xxxxNB Series	Cu Alloy	Sn-Ag		Inside Crystal unit
	RX / RTC-xxxxJE Series	42Alloy	Sn-Ag		Inside Crystal unit
	RX-xxxxLC Series	42Alloy	Sn-Ag		Inside Crystal unit
	RTC-4543SB	42Alloy	Sn-Ag		Inside Crystal unit
	RTC-7301SF	Cu Alloy	Sn-Ag		Inside Crystal unit
	RTC-62423	42Alloy	Sn-Bi		Inside Crystal unit
	RTC-72423	42Alloy	Sn-Bi		Inside Crystal unit
Filter	FF-xxx Series	W	Au	○	
Sensor	HTS-206	Fe-Ni-Co	Sn-Pb		Heat Resistance type Solder
	XV-3500CB	W	Au	○	

TABLE OF FREQUENCY RANGE

■Crystal Oscillator

Page	Frequency		1 Hz	100 kHz	1 MHz	50 MHz	100 MHz	200 MHz	500 MHz	700 MHz
	Model									
26	SG-3030LC / JF / JC SG-3040LC / JC SG-3032JC		●32.768 kHz							
27	SG-310 Series		2 MHz ██████████ 48 MHz							
28	SG-350 Series SG-550 Series		1 MHz ██████████ 48 MHz							
29	SG-710 Series		1.8 MHz ██████████ 125 MHz							
30	SG-645 Series		32.001 MHz ██████████ 135 MHz							
31-32	SG-636 Series		2.21675 MHz ██████████ 135 MHz							
33-34	SG-615 Series		1.025 MHz ██████████ 135 MHz							
	SG-531 Series SG-51 Series		1.025 MHz ██████████ 66.6667 MHz							
43	SG-9001 Series		10 MHz ██████████ 166 MHz							
44	XG-1000CA/CB Series		50 MHz ██████████ 170 MHz							
45	EG-2021CA		62.5 MHz ██████████ 170 MHz							
	EG-2011CA									
47	EG-2121CA	LV-PECL	53.125 MHz ██████████ 500 MHz							
		LVDS	53.125 MHz ██████████ 700 MHz							
	EG-2102CA	LV-PECL	100 MHz ██████████ 700 MHz							
		LVDS	53.125 MHz ██████████ 700 MHz							
48	EG-2101CA		62.5 MHz ██████████ 400 MHz							
46	EG-2002CA		62.5 MHz ██████████ 170 MHz							
45	EG-2001CA		106.25 MHz ██████████ 170 MHz							
49	HG-2150CA		1.0 MHz ██████████ 80 MHz							
50	HG-8002JA		1.0 MHz ██████████ 125 MHz							
56	VG-2828CB		●13 MHz							
54	VG-1201CA		1.0 MHz ██████████ 80 MHz							
53	VG-4231CA		1.0 MHz ██████████ 75 MHz							
55	VG-4030JA		2.0 MHz ██████████ 28.6363 MHz							
57	TG-3530SA		●32.768 kHz							
58	TG-5001LA		13 MHz ██████████ 40 MHz							
51	MG-5020JE		●32.768 kHz ●48.00512 MHz							
52	MG-5100SA		76.9 kHz ██████████ 100 MHz							

■Programmable Crystal Oscillator

Page	Frequency		Operating voltage	Frequency Stability Operating Temperature	1 MHz	50 MHz	100 MHz	125 MHz
	Model							
35	SG-8002CE	PT/ST PH/SH	4.5 V to 5.5 V	B,C M	1.0 MHz ██████████ 125 MHz			
		PC SC	3.0 V to 3.6 V (2.7 V to 3.6 V)	B,C,M	1.0 MHz ██████████ 27 MHz			125 MHz
					1.0 MHz ██████████	*2.7 V to 3.6 V : 1.0 MHz to 66.7 MHz		125 MHz
36	SG-8002LA SG-8002LB	PH/SH	5.0 V±0.5 V	B,C M,L	1.0 MHz ██████████ 80 MHz			
		PC,SC	3.3 V±0.3 V	B,C,M,L	1.0 MHz ██████████ 27 MHz			125 MHz
					1.0 MHz ██████████	*2.7 V to 3.6 V : 1.0 MHz to 66.7 MHz		
37	SG-8002JF	PT/ST PH/SH	4.5 V to 5.5 V	B,C M	1.0 MHz ██████████ 125 MHz			
		PC SC	3.0 V to 3.6 V (2.7 V to 3.6 V)	B,C,M	1.0 MHz ██████████ 40 MHz			125 MHz
					1.0 MHz ██████████	*2.7 V to 3.6 V : 1.0 MHz to 66.7 MHz		125 MHz
37-39	SG-8002CA SG-8002JA SG-8002DB SG-8002DC	PT/ST PH/SH	4.5 V to 5.5 V	B,C M	1.0 MHz ██████████ 125 MHz			
		PC,SC	3.0 V to 3.6 V (2.7 V to 3.6 V)	B,C,M	1.0 MHz ██████████ 55 MHz			125 MHz
					1.0 MHz ██████████	*2.7 V to 3.6 V : 1.0 MHz to 66.7 MHz		125 MHz
38	SG-8002JC	PT/ST PH/SH	4.5 V to 5.5 V	B C	1.0 MHz ██████████ 125 MHz			
		PC,SC	3.0 V to 3.6 V (2.7 V to 3.6 V)	B C	1.0 MHz ██████████	*2.7 V to 3.6 V : 1.0 MHz to 66.7 MHz		125 MHz

Frequency stability: B:±50×10⁻⁶(-20 °C to +70 °C), C:±100×10⁻⁶(-20 °C to +70 °C), M:±100×10⁻⁶(-40 °C to +85 °C), L:±50×10⁻⁶(-40 °C to +85 °C)

TABLE OF DIMENSIONS

■ SMD Type

● SON / DCC

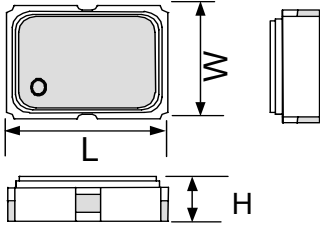

Subject	Model	Dimension (mm)			Pin
		L	W	H	
X'tal	FC-135	3.2±0.1	1.5±0.1	0.8±0.1	2
	FC-145	4.1±0.1	1.5±0.1	0.8±0.1	2
	FC-255	4.9±0.1	1.8±0.1	0.8±0.1	2
	FA-238 / 238V / 23H	3.2±0.1	2.5±0.1	0.6±0.1	4
	FA-365	6.0±0.2	3.5±0.2	1.4 Max.	2
SAW Resonator SAW Filter	FS-335 / NS-32R / FF-32N	3.8±0.15	3.8±0.15	0.98±0.15	6
	FS / FF-555 / 585	4.8±0.2	5.2±0.2	1.5±0.2	8
OSC	SG-310 / SG-8002CE	3.2±0.2	2.5±0.2	1.05±0.15	4
	SG-710	7.3±0.2	4.8±0.2	1.3±0.1	4
	SG-8002CA	7.0±0.2	5.0±0.2	1.5 Max.	4
	VG-4231CA / VG-1201CA	7.0±0.2	5.0±0.2	1.4±0.1	6
	VG-2828CB	5.0±0.2	3.2±0.2	1.2±0.1	4
	HG-2150CA	7.0±0.2	5.0±0.2	1.5 Max.	4
	SG-9001CA	7.0±0.2	5.0±0.2	1.4±0.1	6
	XG-1000CA	7.0±0.2	5.0±0.2	1.2±0.2	4
	XG-1000CB	5.0±0.2	3.2±0.2	1.1±0.15	4
	EG-20**CA	7.0±0.2	5.0±0.2	1.2±0.2	4
	EG-21**CA	7.0±0.2	5.0±0.2	1.2±0.2	6

● SON (X'tal) MC-146

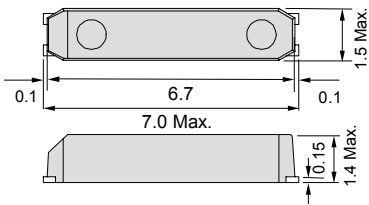

● SON (OSC) SG-350, SG-8002LA / TG-5001LA

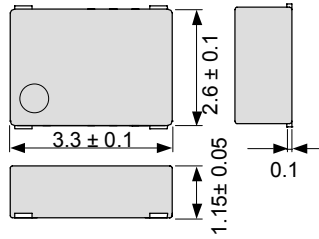

● SON (Real time clock module:NB Package) RX-****NB / RTC-****NB

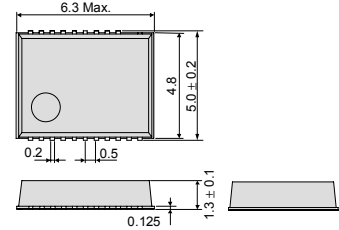

● SOJ / VSOJ

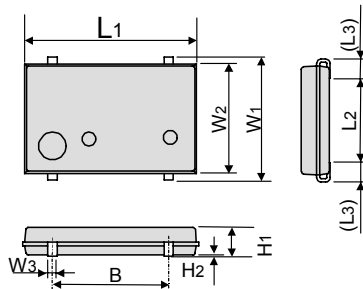

Subject	Model	L1	L2	(L3)	W1	W2	W3	H1	H2	B	Pin
X'tal	MC-156	7.1 Max.	1.6	(0.75)	3.3 Max.	2.5	0.4	1.5 Max.	—	5.08	4
	MC-306 MC-30A MA-306	8.0 Max.	1.9	(0.9)	3.8 Max.	3.2	0.5	2.54 Max.	—	5.5	4
	MA-406	11.7 Max.	2.1	(1.2)	4.8 Max.	4.0	0.7	3.7 Max.	—	9.6	4
	SG-615 SG-**JA VG-**JA HG-**JA	14.0 Max.	7.62	—	9.8 Max.	8.65	0.51	4.7 Max.	0.25 Min.	5.08	4
OSC	SG-636 SG-**JC VG-**JC HG-**JC	10.5 Max.	3.6	(1.0)	5.8 Max.	5.0	0.51	2.7 Max.	0.05 Min.	5.08	4
	SG-645 SG-**JF VG-**JF HG-**JF	7.1 ±0.2	3.8	(0.75)	5.1 ±0.2	4.6 ±0.2	0.4	1.5 Max.	0.0 Min.	5.08	4
	SG-550 SG-**LB	5.0 ±0.2	2.5	(0.35)	3.2 ±0.2	2.8	1.0	1.2 Max.	0.0 Min.	2.54	4
	Real time Clock Module RX-**LC	3.6 ±0.2	2.0	(0.4)	2.8 ±0.2	2.4	0.22	1.2 Max.	0.0 Min.	0.5	12
	OSC MG-**JE	7.0 ±0.3	4.5	(0.75)	6.0 ±0.2	5.4	0.22	1.5 Max.	0.0 Min.	0.65	20
Real time Clock Module RTC-**JE	7.0 ±0.3	4.5	(0.75)	6.0 ±0.2	5.4	0.22	1.5 Max.	0.0 Min.	0.65	20	

● SOJ

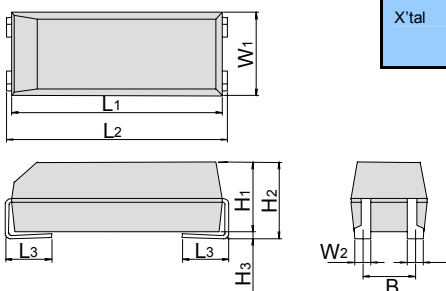

Subject	Model	L1	L2	L3	W1	W2	B	H1	H2	H3
X'tal	MC-405 / 406	9.6	10.41 Max.	2.54	4.06 Max.	0.51	2.29	3.15	3.6 Max.	0.2 Min.
	MA-505 / 506	12.7	13.46 Max.	2.54	5.08 Max.	1.09	3.3	4.19	4.6 Max.	0.2 Min.

● SOP / VSOP

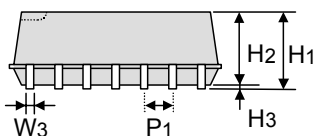
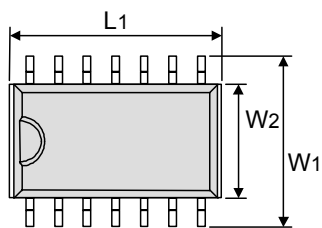

Subject	Model	L ₁	L ₂	W ₁	W ₂	W ₃	H ₁	H ₂	H ₃	D ₁	P ₁	Pin
OSC	MG-5100SA											
	RTC-****SA	10.1 ±0.2	0.6	7.4 ±0.2	5.0	0.35	3.2 ±0.1	3.1	0.05 Min.	0.15	1.27	14
	RX-****SA											
	RA-****SA											
	RTC-4543SB	11.4 ±0.2	0.6	7.8 ±0.2	5.4	0.4	2.0 Max.	1.8	0 Min.	0.15	1.27	18
Real time Clock Module	RTC-62423	16.3 Max.	1.0	12.2 Max.	7.9	0.35	2.8 Max.	—	0.1 Min.	0.2	1.27	24
	RTC-72423	10.2 ±0.3	0.5	7.8 ±0.3	5.4	0.36	2.0 Max.	—	0 Min.	0.15	0.8	24
	RTC-7301SF											

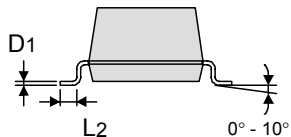

■ Dip Type

● Cylinder

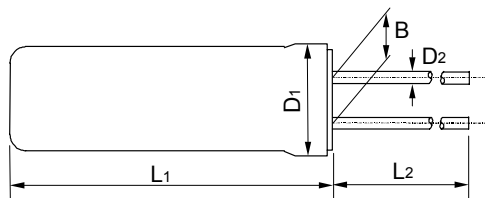

Subject	Model	L ₁	L ₂	D ₁	D ₂	B	
X'tal	C-001R	8.0 Max.	9.0 Min.	Φ3.1 Max.	Φ0.3	1.1	
	C-002RX / C-2-TYPE	6.0 Max.	4.0 Min.	Φ2.0 Max.	Φ0.2	0.7	
	C-004R / C-4-TYPE	5.0 Max.	4.0 Min.	Φ1.5 Max.	Φ0.18	0.5	
	C-005R	4.6 Max.	4.0 Min.	Φ1.2 Max.	Φ0.15	0.3	
	CA-301	Over 5.5 MHz	8.9 Max.	9.5 Min.	Φ3.1 Max.	Φ0.3	1.1
		Under 5.5 MHz	9.3 Max.	9.5 Min.	Φ3.1 Max.	Φ0.3	1.1

● DIP

Subject	Model	L ₁	L ₂	L ₃	L ₄	H ₁	H ₂	W ₁	Pin
OSC	SG-51	19.8 Max.	0.51	—	15.24	5.3 Max.	2.54 Min.	6.36	4
	SG-8002DB								
	SG-531	13.7 Max.	0.51	—	7.62	5.3 Max.	2.54 Min.	6.6	4
Real time Clock Module	SG-8002DC								
	RTC-7301DG	23.1 Max.	0.46	2.54	20.32	4.2 Max.	2.54 Min.	6.3	18
	RTC-62421	23.1 Max.	0.65	2.54	20.32	4.2 Max.	3.3 Min.	6.3	18
	RTC-72423								

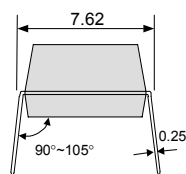
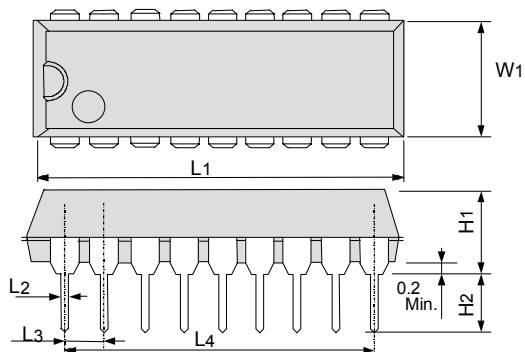

HANDLING PRECAUTIONS

Common points for all products

1. Shock resistance

Epson's crystal products are designed to resist physical shocks, but crystal products may be damaged under some conditions, such as dropping from desks or receiving shocks during mounting. Please be sure to re-check the characteristics if product has received any shocks.

2. Soldering heat resistance

Epson's crystal products except SMD products use solder having a +180°C to +200°C melting point. Heating up the package more than +150°C may deteriorate the characteristics or damage the products. If the crystal products need to be soldered at temperature of more than +150°C, SMD products are recommended. Giving higher temperature over the following reflow conditions to crystal products, even SMD products, may cause the characteristics to deteriorate. The reflow conditions within following profile is recommendable. Always check the soldering temperature and time before mounting these products. Also, please check them again when the mounting conditions are changed. Please contact us for inquiries about heat-resistance if crystal products need to be soldered over the following profile.

(1) Cylinder products and DIP products

Model	Soldering conditions
[Cylinder] C-TYPE, C-2-TYPE, C-4-TYPE, HTS-206	+280 °C or under @ max. 5 s. Do not heat the package at more than +150 °C.
[Cylinder] CA-301 [DIP] SG-51/531, SG-8002DB/DC, RTC-62421/72421/7301DG	+260 °C or under @ max. 10 s. Do not heat the package at more than +150 °C.

(2) SMD products Reflow profile(example)

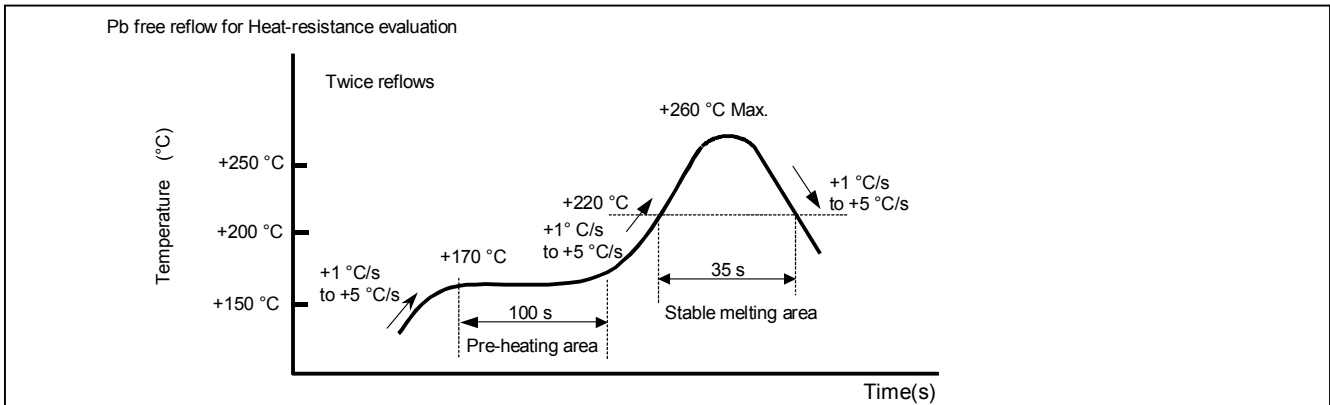

Please make temperature rate as gentle curve as possible. Also, if the package is cellular, the possibility of cracking is inevitable, so please store it for a short duration and take measures to damp-proof when you store it in high humidity.

3. Mounting precautions

Shocks by auto mounting

Shocks caused by auto mounting and vacuuming may deteriorate the characteristics and affect the products. Please set the mounting conditions to minimize the shocks as much as possible, and be sure that there is no affect on the characteristics before mounting. Please review the conditions after the conditions are changed. Also please be sure that crystal products don't hit machines or other electric boards, etc. before or after mounting.

(1) Cylinder products

Bending the lead on the glass or pulling the lead strongly may cause any crack of the hermetic seal glass at the root of the lead and may cause the airtightness and the characteristics to deteriorate. When the lead of crystal products need to be bent as in the figure below, leave more than 0.5mm of lead from the case and hold the lead to prevent the lead from cracks. When the lead needs to be repaired, do not pull it, and hold the bent part to correct it. Giving undue pressure on the portion of hermetic seal may cause the airtightness to deteriorate. Please avoid giving pressure and then gluing the case of products on the electric board is recommended to prevent the airtightness from deteriorating.

Installation example

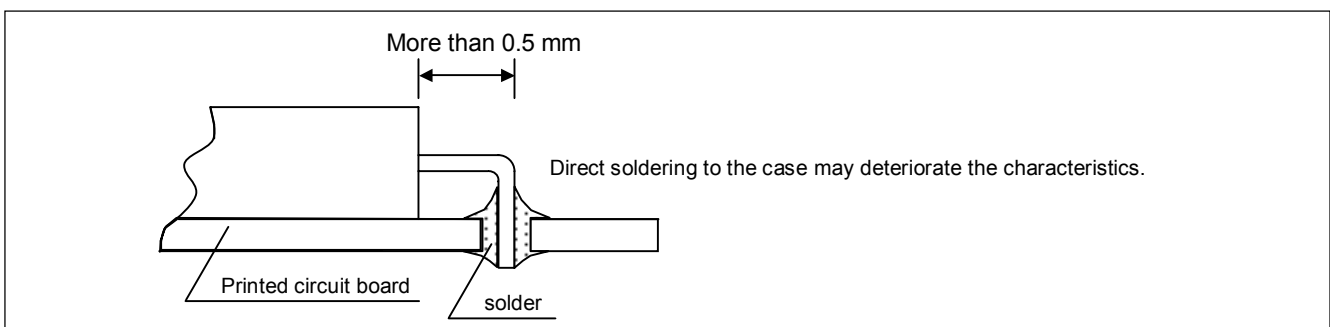

- (2) DIP products
Deformed leads cannot be inserted into board holes. Avoid applying stress sufficient to deform leads.
- (3) SOJ Products and SOP products
Please avoid applying stress sufficient to deform the leads.
Deformed leads may cause incorrect soldering.
Particularly SOP products need to be handled with the greatest care.
- (4)1. Ceramic package products and SON products
Bending the board after soldering ceramic package products and SON products (MC-146,RTC-****NB,RX-****NB) may cause peeling off portions of soldering or package cracks by mechanical stress. Particularly, in the case of cutting boards after soldering these products, please be sure to layout the crystal on a less stressed location and use less stressed cutting method.
- 2. Ceramic package products
In the case of soldering ceramic package products on a different expansion-coefficient board (ex. Epoxy Glass),soldering crack at the foot pattern would be expected under repeated temperature changes for a long period. Under these conditions, be sure to check the solderability in advance.

4. Ultrasonic cleaning

- Products using AT-cut crystal and SAW resonator/filter can be cleaned by ultrasonic. But under some conditions, the crystal characteristics may be affected and internal wiring may be damaged. Please be sure to check the suitability of your system in advance.
- Products using tuning-fork crystals cannot be guaranteed if cleaned using ultrasonic methods, because crystal may be destroyed.

5. The affect of mechanical vibration

While there is any given shock or mechanical vibration periodically such as a piezo sounder, a piezo buzzer, and speaker, to crystal products, output frequency and amplitude can be changed. Especially the quality of telecommunication equipment could be affected by this phenomenon. Although Epson's crystal products are designed to minimize the effect of mechanical vibration, Epson recommends to check them in advance and then follow the Mounting guidelines as below.

●Mounting guidelines

- (1) Ideally, the mechanical buzzer source should be mounted on a separate PCB from the crystal device.
- (2) It is advisable to use cushion or cutting PCB, if you mount on same PCB.
- (3) Traveling mechanical vibration is different just PCB or inside body. Last of all, it is advisable to conform to inside body characteristics.

6. Storage

- (1) Storing the crystal products under higher or lower temperature or high humidity for a long period may affect frequency stability or solderability. Please store the crystal products at the normal temperature and humidity, avoid storing them for a long period and mount them as soon as possible after unpacking.
Normal temperature and humidity:
Temp,+15 °C to+35 °C, humidity 25 % RH to 85 % RH(refer to the standard conditions of test site JIS Z-8703)
- (2) Please carefully handle the inner and outer boxes and reel. External pressure may cause deformation of reel and tape.

■Crystal unit

1. Drive level

Applying excessive drive level to the crystal units may cause deterioration of characteristics or damage. Circuit design must be such as to maintain a proper drive level.(refer to page 9 "Drive level")

2. Negative resistance

Unless adequate negative resistance is allocated in the oscillation circuit, oscillation or oscillation start up time may increase (refer to page 10 "Allowance for Oscillation".)

3. Load capacitance

Differences in the load capacitance in the oscillation circuit may result in deviations in the oscillation frequency from the desired frequency. Attempting to tune by force may merely cause abnormal oscillation. Before use, please specify the load capacitance of the oscillation circuit.(refer to page 10 "Load capacitance")

QUARTZ DEVICE FOR AUTOMOTIVE



This mark is displayed to indicate higher reliability products specifically developed for automotive use.

Low-medium frequency crystal unit

MC-30A (Page.16)

●Target application

- ECU sub clock(Power window/ seat, Key-less entry, Immobilizer etc.)
- Clock
- Instrument panel display
- Bluetooth sub clock
- Clock of ITS (Telematics,VICS,ETC),Clock / sub clock

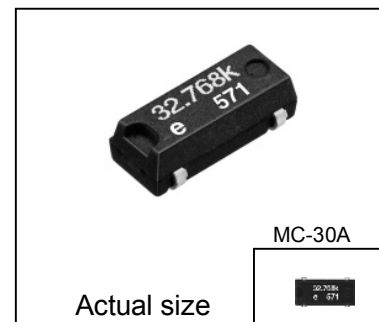

Real time clock module

Serial interface

3-Wire
I²Cbus

RA-4574SA (Page.65)
RA-8581SA (Page.71)

●Target application

- Clock of ITS (Telematics •VICS •ETC) / sub clock/ Timing control

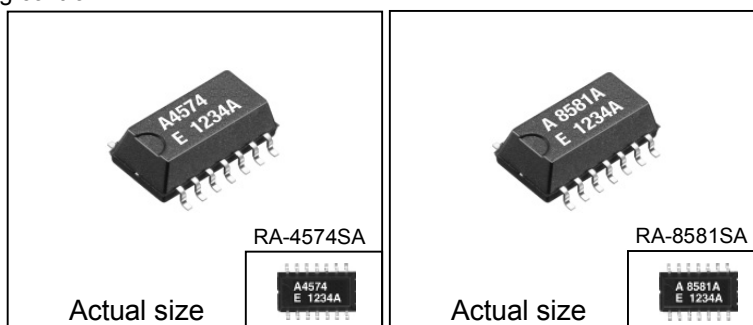

SAW device

SAW resonator

FS-585 (Page.25)

●Target application

- TPMS transmitter

FS-335 / 555 / NS-32R (Page.24)

●Target application

- Key-less entry transmitter
- Smart key transmitter

FF-585 (Page.77)

●Target application

- TPMS receiver

FF-555 (Page.76)

●Target application

- Key-less entry receiver
- Smart key receiver

FF-32N (Page.75)

●Target application

- Key-less entry receiver
- Smart key receiver, TPMS receiver

SAW filter

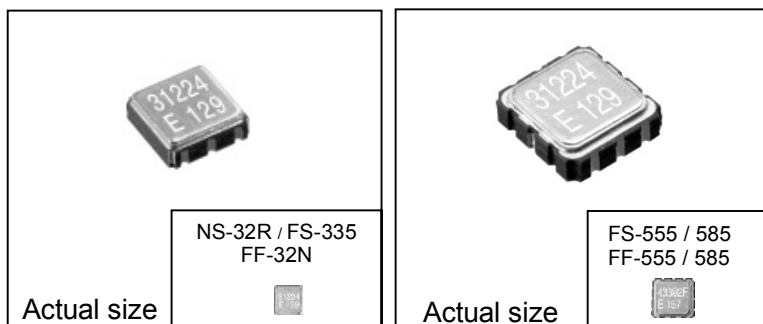

THIN SMD LOW / MEDIUM-FREQUENCY CRYSTAL UNIT

FC - 135 / 145 / 255

Product number (please contact us)

- FC-135 : Q1xFC1350xxxx00
- FC-145 : Q13FC1450xxxx00
- FC-255 : Q1xFC2550xxxx00

- Frequency range : 32.768 kHz (32 kHz to 100 kHz)
- Thickness : 0.8 mm Typ.
- Overtone order : Fundamental
- Applications : Small communications devices
- Lead(Pb)-free : Complies with EU RoHS directive

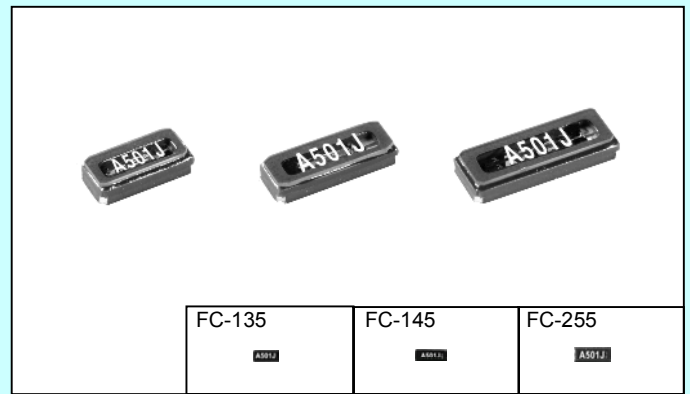

Actual size

Specifications (characteristics)

Item	Symbol	Specifications				Remarks
		FC-135 / 145	FC-255	FC-135	FC-255	
Nominal frequency range	f	32.768 kHz		32 kHz to 77.5 kHz	32 kHz to 100 kHz	please contact us for inquiries about the available frequency
Temperature range	Storage temperature	-55 °C to +125 °C				Stored as bare product after unpacking
	Operating temperature	-40 °C to +85 °C				
Maximum drive level	GL	0.5 μW Max.				
Frequency tolerance (standard)	Δf/f	±20 × 10 ⁻⁶		±50 × 10 ⁻⁶	±100 × 10 ⁻⁶	T _a =+25 °C, DL=0.1 μW Please ask tighter tolerance
Peak temperature (frequency)	ΘT	+25 °C ±5 °C				
Temperature coefficient (frequency)	a	-0.04 × 10 ⁻⁶ / °C ² Max.				
Load capacitance	CL	9 pF, 12.5 pF	7 pF, 12.5 pF	9 pF, 12.5 pF	7 pF, 12.5 pF	Please specify
Series resistance	R ₁	70 kΩ Max.	65 kΩ Max.	70 kΩ to 45 kΩ	70 kΩ to 30 kΩ	
Motional capacitance	C ₁	3.4 fF Typ.	2.0 fF Typ.	3.7 fF to 1.6 fF	2.3 fF to 0.6 fF	
Shunt capacitance	C ₀	1.0 pF Typ.	1.3 pF Typ.	1.3 pF to 0.5 pF	1.7 pF to 0.9 pF	
Insulation resistance	IR	500 MΩ Min.				
Aging	fa	±3 × 10 ⁻⁶ / year Max.				T _a = +25 °C ±3 °C, first year
Shock resistance	S.R.	±8 × 10 ⁻⁶ Max.				100 g dummy (Seiko Epson Standard) drop from 1500 mm height on to the concrete 3 directions 10 times.

External dimensions

(Unit:mm)

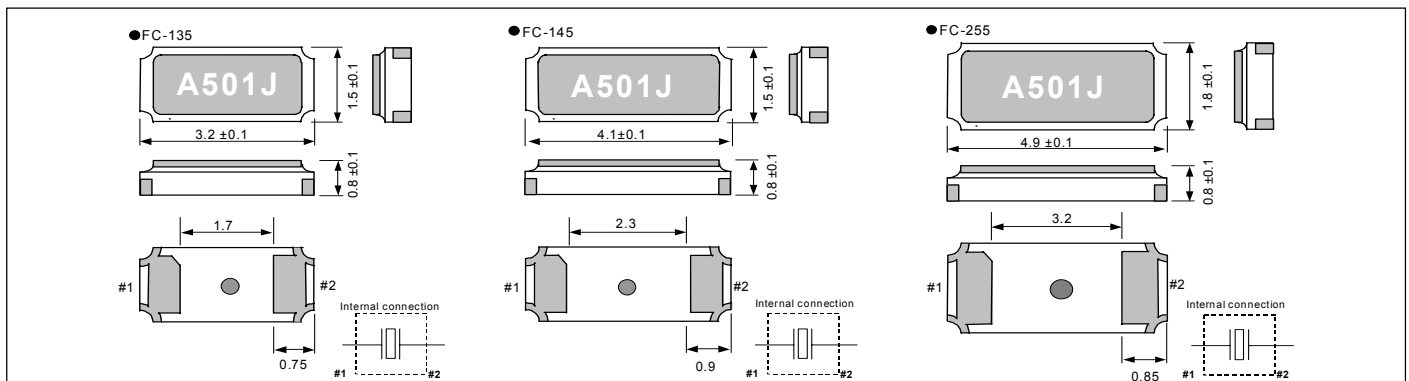

Recommended soldering pattern

(Unit:mm)

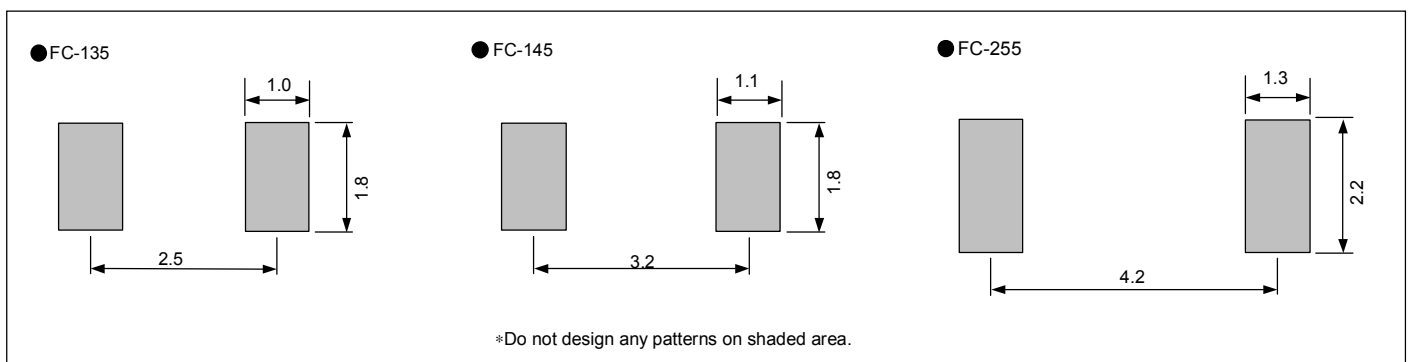

THIN SMD LOW / MEDIUM-FREQUENCY CRYSTAL UNIT

MC-146 / 156

Product number (please contact us)

MC-146 : Q1xMC1461xxxx00

MC-156 : Q1xMC1561xxxx00

- Frequency range : 32.768 kHz (32 kHz to 100 kHz)
- Thickness : 1.4 mm Max. (MC-146)
1.5 mm Max. (MC-156)
- Overtone order : Fundamental
- Applications : Small communications devices
- Lead(Pb)-free : Complies with EU RoHS directive

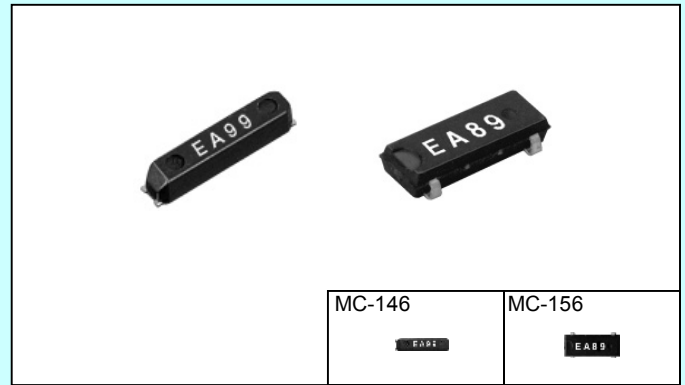

Actual size

■ Specifications (characteristics)

Item	Symbol	Specifications		Remarks
Nominal frequency range	f	32.768 kHz	32 kHz to 100 kHz	Please contact us for inquiries regarding available frequencies
Temperature range	Storage temperature	T _{STG} -55 °C to +125 °C		Stored as bare product after unpacking
	Operating temperature	T _{OPR} -40 °C to +85 °C		
Maximum drive level	GL	1.0 μW Max.		Operating Drive level 0.5 μW Max.
Frequency tolerance (standard)	Δf/f	± 20 × 10 ⁻⁶ , ± 50 × 10 ⁻⁶	± 50 × 10 ⁻⁶ , ± 100 × 10 ⁻⁶	T _a =+25 °C, DL=0.1 μW
Peak temperature (frequency)	Θ _T	+25 °C ± 5 °C		
Temperature coefficient (frequency)	a	-0.04 × 10 ⁻⁶ / °C ² Max.		
Load capacitance	C _L	7 pF, 12.5 pF		Please specify
Series resistance	R ₁	65 kΩ Max.	65 kΩ to 25 kΩ	
Motional capacitance	C ₁	1.9 fF Typ.	2.5 fF to 0.6 fF	
Shunt capacitance	C ₀	0.8 pF Typ.	1.2 pF to 0.5 pF	
Insulation resistance	IR	500 MΩ Min.		
Aging	fa	±3 × 10 ⁻⁶ / year Max.		T _a = +25 °C ±3 °C, first year
Shock resistance	S.R.	±5 × 10 ⁻⁶ Max.		100 g dummy (Seiko Epson Standard) drop from 1500 mm height on to the concrete 3 directions 10 times.

■ External dimensions

(Unit:mm)

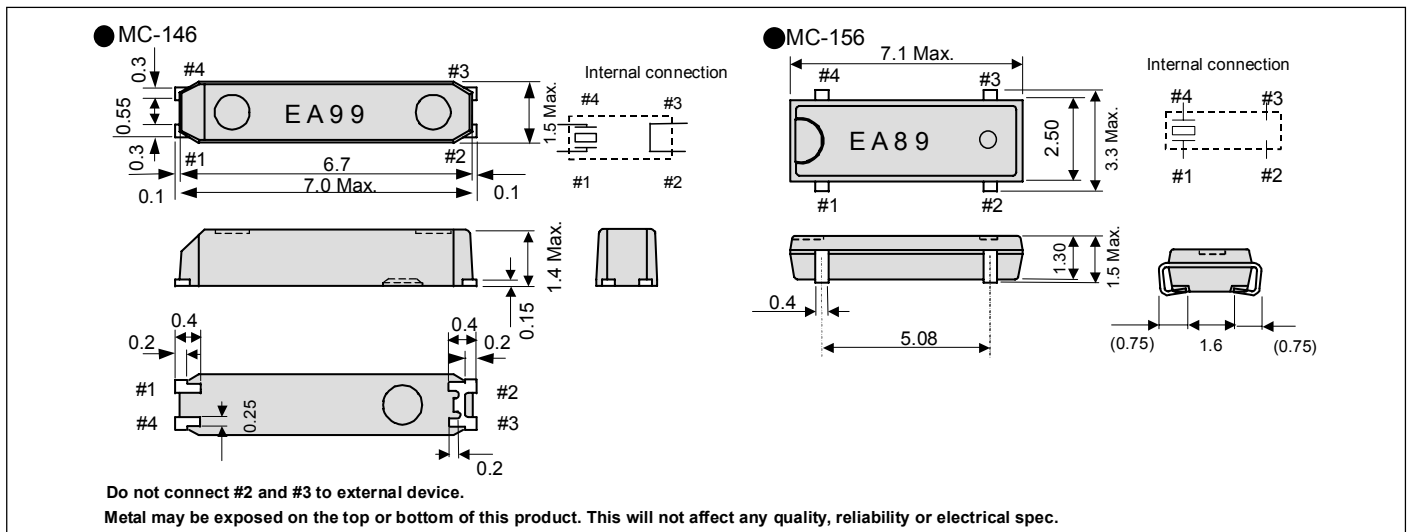

■ Recommended soldering pattern

(Unit:mm)

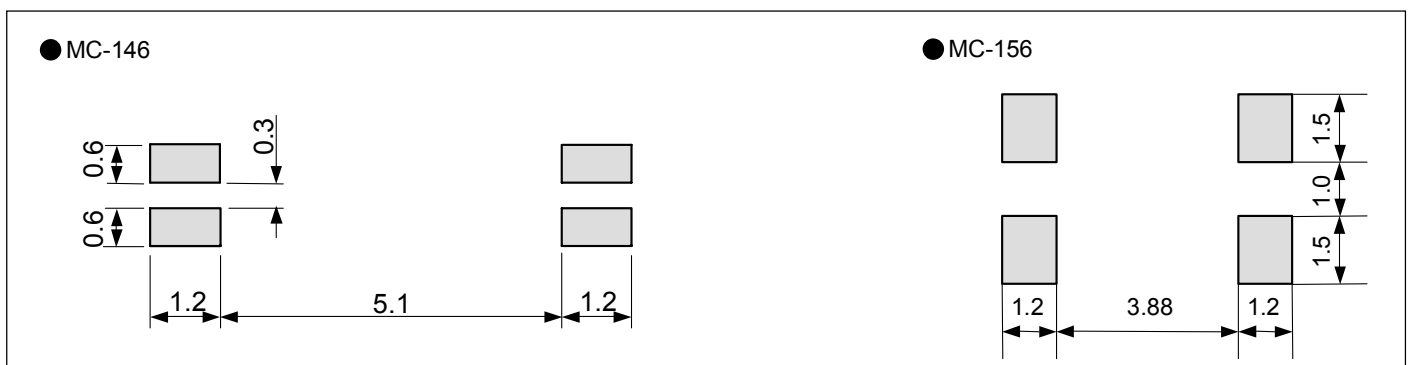

SMD LOW / MEDIUM-FREQUENCY CRYSTAL UNIT

MC - 306 / 405 / 406

Product number (please contact us)

- MC-306 : Q1xMC3061xxxx00
- MC-405 : Q1xMC4051xxxx00
- MC-406 : Q1xMC4061xxxx00

- Frequency range : 32.768 kHz (20 kHz to 165 kHz)
- Thickness : 2.54 mm Max.(MC-306)
3.60 mm Max.(MC-405 / 406)
- Overtone order : Fundamental /Overtone (307.2 kHz)
- Applications : Clock and Microcomputer
- Lead(Pb)-free : Complies with EU RoHS directive

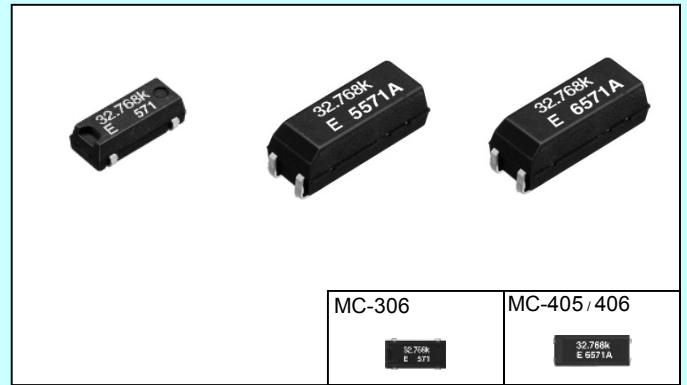

Actual size

Specifications (characteristics)

Item	Symbol	Specifications		Remarks
Nominal frequency range	f	32.768 kHz	20 kHz to 165 kHz 307.2 kHz(MC-405 / 406)	Please contact us regarding available frequencies
Temperature range	Storage temperature	-55 °C to +125 °C		Stored as bare product after unpacking
	Operating temperature	-40 °C to +85 °C		
Maximum drive level	GL	1.0 μW Max.		
Frequency tolerance (standard)	Δf/f	±20 × 10 ⁻⁶ , ±50 × 10 ⁻⁶	±50 × 10 ⁻⁶ , ±100 × 10 ⁻⁶	T _a =+25 °C, DL=0.1 μW
Peak temperature (frequency)	ΘT	+25 °C ±5 °C		
Temperature coefficient (frequency)	a	-0.04 × 10 ⁻⁶ / °C ² Max.		
Load capacitance	CL	6 pF to ∞ (standard :12.5 pF)		Please specify
Series resistance	R ₁	50 kΩ Max.	55 kΩ to 6 kΩ	As per below table
Motional capacitance	C ₁	1.8 fF Typ.	4.0 fF to 0.6 fF	MC-306
		2.0 fF Typ.		MC-405 / 406
Shunt capacitance	C ₀	0.9 pF Typ.	2.0 pF to 0.6 pF	MC-306
		0.85 pF Typ.		MC-405 / 406
Insulation resistance	IR	500 MΩ Min.		
Aging	fa	±3 × 10 ⁻⁶ / year Max.	±5 × 10 ⁻⁶ / year Max.	T _a =+25 °C ±3 °C, first year
Shock resistance	S.R.	±5 × 10 ⁻⁶ Max.		Three drops on a hard board from 750 mm or excitation test with 29400 m/s ² x 0.3 ms x 1/2 sine wave x 3 directions

Series resistance

Frequency	20 kHz≤f< 31.2 kHz	31.2 kHz≤f< 40 kHz	40 kHz≤f< 90 kHz	90 kHz≤f< 130 kHz	130 kHz≤f<165 kHz	307.2 kHz
Series resistance	55 kΩ Max.	35 kΩ Max.	20 kΩ Max.	12 kΩ Max.	10 kΩ Max.	6 kΩ Max.

External dimensions

(Unit:mm)

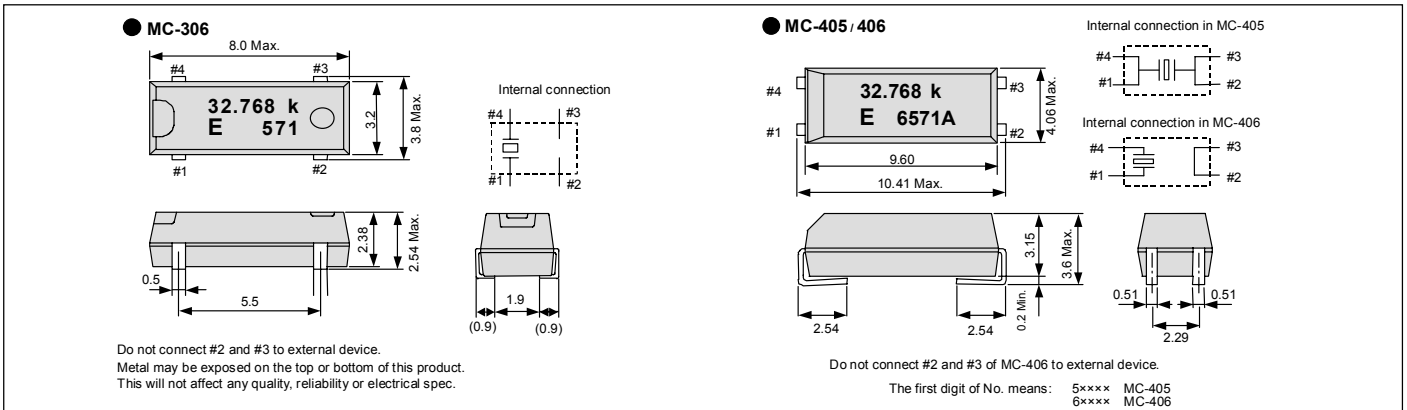

Recommended soldering pattern

(Unit:mm)

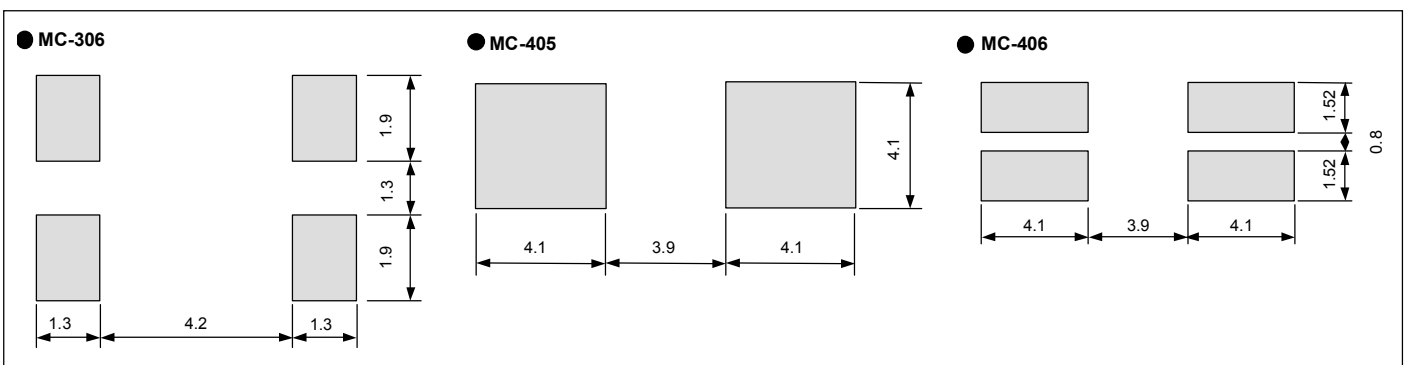

**SMALL SMD LOW / MEDIUM-FREQUENCY CRYSTAL UNIT
FOR AUTOMOTIVE APPLICATIONS**

MC-30A

Product number (please contact us)
Q1xMC30A1xxxx00

- Frequency range : 32.768 kHz (20 kHz to 165 kHz)
- Thickness : 2.54 mm Max.
- Overtone order : Fundamental
- Applications : Accessories and ECU sub clock
- Lead(Pb)-free : Complies with EU RoHS directive

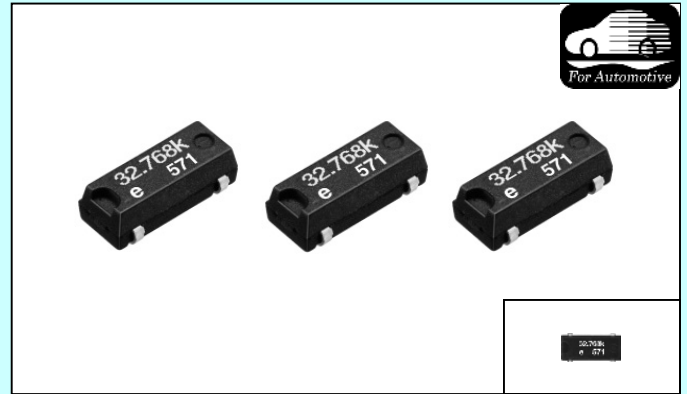

Actual size

Specifications (characteristics)

Item	Symbol	Specifications		Remarks
Nominal frequency range	f	32.768 kHz	20 kHz to 165 kHz	Please contact us regarding available frequencies
Temperature range	Storage temperature T _{STG}	-55 °C to +125 °C		Stored as bare product after unpacking
	Operating temperature T _{OPR}	-40 °C to +85 °C		
Maximum drive level	GL	1.0 μW Max.		
Frequency tolerance (standard)	Δf/f	±20 × 10 ⁻⁶ , ±50 × 10 ⁻⁶	±50 × 10 ⁻⁶ , ±100 × 10 ⁻⁶	T _a =+25 °C, DL=0.1 μW
Peak temperature (frequency)	ΘT	+25 °C ±5 °C		
Temperature coefficient (frequency)	a	-0.04 × 10 ⁻⁶ / °C ² Max.		
Load capacitance	C _L	6 pF to ∞ (standard : 12.5 pF)		Please specify
Series resistance	R ₁	50 kΩ Max.	55 kΩ to 10 kΩ	As per below table
Motional capacitance	C ₁	1.8 fF Typ.	4.0 fF to 0.6 fF	
Shunt capacitance	C ₀	0.9 pF Typ.	2.0 pF to 0.6 pF	
Insulation resistance	IR	500 MΩ Min.		
Aging	fa	±3 × 10 ⁻⁶ / year Max.	±5 × 10 ⁻⁶ / year Max.	T _a = +25 °C ±3 °C, first year
Shock resistance	S.R.	±5 × 10 ⁻⁶ Max.		Three drops on a hard board from 1000 mm

Series resistance (R₁)

Frequency	20 kHz ≤ f < 31.2 kHz	31.2 kHz ≤ f < 40 kHz	40 kHz ≤ f < 90 kHz	90 kHz ≤ f < 130 kHz	130 kHz ≤ f ≤ 165 kHz
Series resistance	55 kΩ Max.	35 kΩ Max.	20 kΩ Max.	12 kΩ Max.	10 kΩ Max.

External dimensions

(Unit:mm)

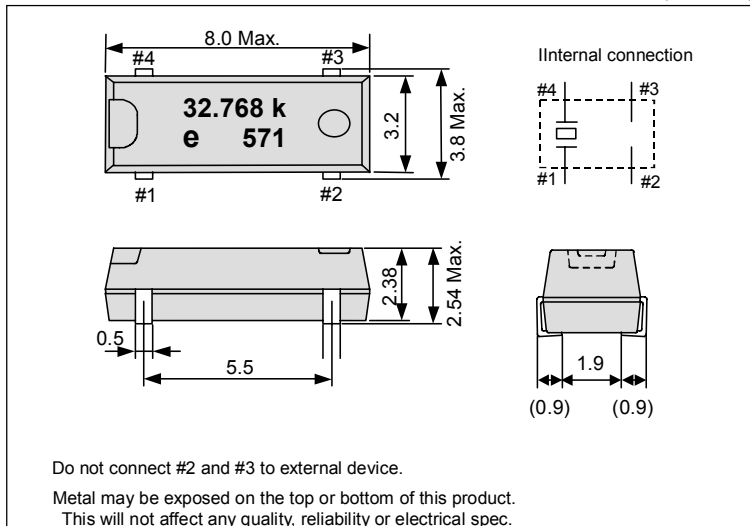
Recommended soldering pattern

(Unit:mm)

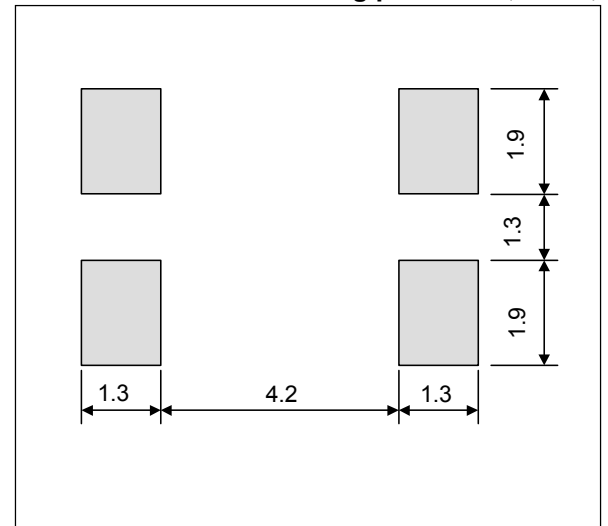

CYLINDER LOW/MEDIUM-FREQUENCY CRYSTAL UNIT

C - TYPE
C - 2 - TYPE C - 4 - TYPE

Product number (please contact us)

- C-001R : Q11C001R1xxxx00
- C-002RX : Q11C02RX1xxxx00
- C-004R : Q11C004R1xxxx00
- C-005R : Q11C005R1xxxx00
- C-2-TYPE : Q12C20001xxxx00
- C-4-TYPE : Q12C40001xxxx00

- Frequency range : 32.768 kHz (20 kHz to 307.2 kHz)
- Thickness : Ø1.2 mm to Ø3.1 mm
- Overtone order : Fundamental / Overtone(192 kHz,307.2 kHz)
- Applications : Clock and Microcomputer
- Lead(Pb)-free : Complies with EU RoHS directive (Lead free completely)

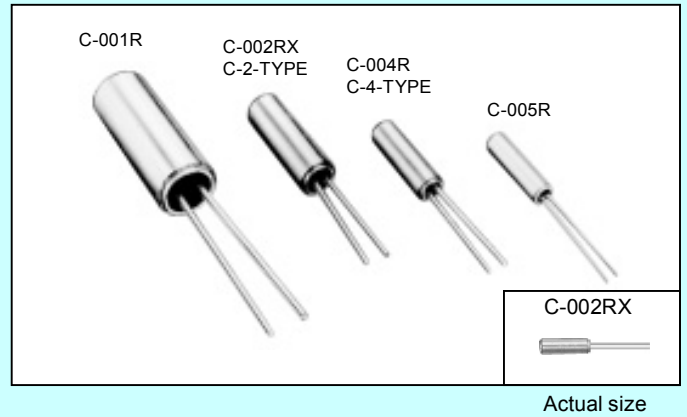

■ Specifications for C-TYPE (characteristics)

Item	Symbol	C-001R	C-002RX	C-004R	C-005R	Remarks
Nominal frequency range	f	32.768 kHz				
Temperature range	Storage temperature	-20 °C to +70 °C				Stored as bare product after unpacking
	Operating temperature	-10 °C to +60 °C				
Maximum drive level	GL	1.0 µW Max.				
Frequency tolerance (standard)	Δf/f	±20 × 10 ⁻⁶				T _a =+25 °C, DL=0.1 µW
Peak temperature (frequency)	ΘT	+25 °C ±5 °C				
Temperature coefficient (frequency)	a	-0.04 × 10 ⁻⁶ / °C ² Max.				
Load capacitance	C _L	6 pF to ∞				Please specify
Series resistance	R ₁	35 kΩ Max. (18 kΩ Typ.)	50 kΩ Max. (30 kΩ Typ.)	50 kΩ Max. (37 kΩ Typ.)		
Motional capacitance	C ₁	2.1 fF Typ.	2.0 fF		1.9 fF Typ.	
Shunt capacitance	C ₀	0.9 pF Typ.	0.85 pF		0.75 pF Typ.	
Insulation resistance	IR	500 MΩ Min.				
Aging	fa	±3 × 10 ⁻⁶ / year Max.				T _a =+25 °C ±3 °C, first year
Shock resistance	S.R.	±5 × 10 ⁻⁶ Max				Three drops on a hard board from 750 mm or excitation test with 29400 m/s ² x 0.3 ms x 1/2 sine wave x 3 directions

■ Specifications for C-2-TYPE C-4-TYPE (characteristics)

Item	Symbol	Specifications		Remarks
		C-2-TYPE	C-4-TYPE	
Nominal frequency range	f	20 kHz to 165 kHz, 307.2 kHz	32 kHz to 120 kHz, 192 kHz	Overtone (192 kHz,307.2 kHz)
Temperature range	Storage temperature	-20 °C to +70 °C		Stored as bare product after unpacking
	Operating temperature	-10 °C to +60 °C		
Maximum drive level	GL	1.0 µW Max.		
Frequency tolerance (standard)	Δf/f	±20 × 10 ⁻⁶ , ±50 × 10 ⁻⁶ , ±100 × 10 ⁻⁶ (307.2 kHz:±100 × 10 ⁻⁶)	±50 × 10 ⁻⁶ , ±100 × 10 ⁻⁶	T _a =+25 °C, DL=0.1 µW
Peak temperature (frequency)	ΘT	+25 °C ±5 °C		
Temperature coefficient (frequency)	a	-0.04 × 10 ⁻⁶ / °C ² Max.		
Load capacitance	C _L	6 pF to ∞		Please specify
Series resistance	R ₁	55 kΩ to 6 kΩ	55 kΩ to 10 kΩ	As per below table
Motional capacitance	C ₁	4.0 fF to 0.6 fF		
Shunt capacitance	C ₀	2.0 pF to 0.6 pF		
Insulation resistance	IR	500 MΩ Min.		
Aging	fa	±5 × 10 ⁻⁶ / year Max.		T _a =+25 °C ±3 °C, first year
Shock resistance	S.R.	±5 × 10 ⁻⁶ Max.		Three drops on a hard board from 750 mm or excitation test with 29400 m/s ² x 0.3 ms x 1/2 sine wave x 3 directions

■ Series resistance C-2- TYPE

Frequency	20 kHz ≤ f < 31.2 kHz	31.2 kHz ≤ f < 40 kHz	40 kHz ≤ f < 90 kHz	90 kHz ≤ f < 130 kHz	130 kHz ≤ f < 165 kHz	307.2 kHz
Series resistance	55 kΩ Max.	35 kΩ Max.	20 kΩ Max.	12 kΩ Max.	10 kΩ Max.	6 kΩ Max.

■ Series resistance C-4- TYPE

Frequency	32 kHz ≤ f < 38 kHz	38 kHz ≤ f < 50 kHz	50 kHz ≤ f < 74 kHz	74 kHz ≤ f < 100 kHz	100 kHz ≤ f < 120 kHz	192 kHz
Series resistance	50 kΩ Max.	30 kΩ Max.	25 kΩ Max.	22 kΩ Max.	15 kΩ Max.	10 kΩ Max.

■ External dimensions

(Unit:mm)

Model	L ₁	L ₂	D ₁	D ₂	B
C-001R	8.0 Max.	9.0 Min.	φ 3.1 Max.	φ 0.3	1.1
C-002RX C-2-TYPE	6.0 Max.	4.0 Min.	φ 2.0 Max.	φ 0.2	0.7
C-004R C-4-TYPE	5.0 Max.	4.0 Min.	φ 1.5 Max.	φ 0.18	0.5
C-005R	4.6 Max.	4.0 Min.	φ 1.2 Max.	φ 0.15	0.3

160 kHz to 165 kHz, 307.2 kHz: D₁ = ø 2.2 Max.

THIN SMD HIGH-FREQUENCY CRYSTAL UNIT

FA-238V / 238

Product number (please contact us)

FA-238V : Q22FA23V0xxxx00

FA-238 : Q22FA2380xxxx00

- Frequency range : 12 MHz to 50 MHz
- Thickness : 0.6 mm Typ.
- Overtone order : Fundamental
- Applications : Small communications devices
- Lead(Pb)-free : Complies with EU RoHS directive (Lead free completely)

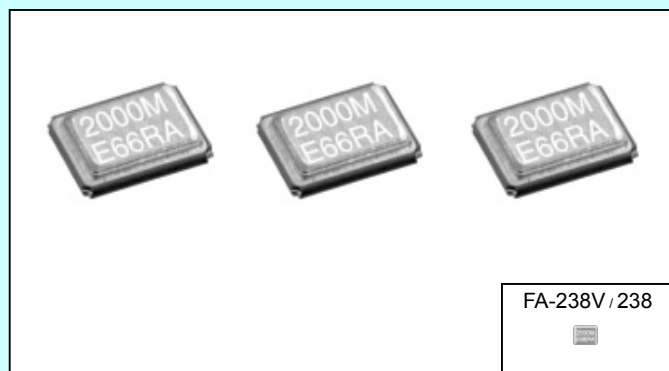

Actual size

■ Specifications (characteristics)

Item	Symbol	Specifications		Remarks
		FA-238V	FA-238	
Nominal frequency range	f	12.000 MHz to 15.999 MHz	16.000 MHz to 50.000 MHz	Fundamental For the out of standard specifications, please contact us for inquiries.
Temperature Range	Storage temperature	-40 °C to +125 °C		Stored as bare product after unpacking Specified equivalent series must be satisfied
	Operating temperature	-40 °C to +85 °C		
Recommended drive level	DL	10 μW to 100 μW		
Frequency tolerance	Δf/f	±50 × 10 ⁻⁶ (standard), (±15 × 10 ⁻⁶ to ±50 × 10 ⁻⁶ is available)		T _a = +25 °C For the out of standard specifications, please contact us for inquiries.
Frequency temperature characteristics (standard)		±30 × 10 ⁻⁶		-20 °C to +70 °C For the out of standard specifications, please contact us for inquiries.
Load capacitance	C _L	7 pF to ∞ (standard:10 pF)		For the out of standard specifications, please contact us for inquiries.
Series resistance	R ₁	As per below table		Operable temperature range, DL = 100 μW
Shunt capacitance	C ₀	5 pF Max.		
Insulation resistance	IR	500 MΩ Min.		
Aging	fa	±5 × 10 ⁻⁶ / year Max.		T _a = +25 °C, first year

*1 For over 40MHz, only the standard specification applies.

■ Series resistance (R₁)

Frequency	Series resistance
12.0 MHz ≤ f ≤ 13.0 MHz	100 Ω Max.
13.0 MHz < f < 20.0 MHz	80 Ω Max.
20.0 MHz ≤ f < 25.0 MHz	60 Ω Max.
25.0 MHz ≤ f < 30.0 MHz	50 Ω Max.
30.0 MHz ≤ f ≤ 50.0 MHz	40 Ω Max.

■ External dimensions

(Unit:mm) ■ Recommended soldering pattern (Unit:mm)

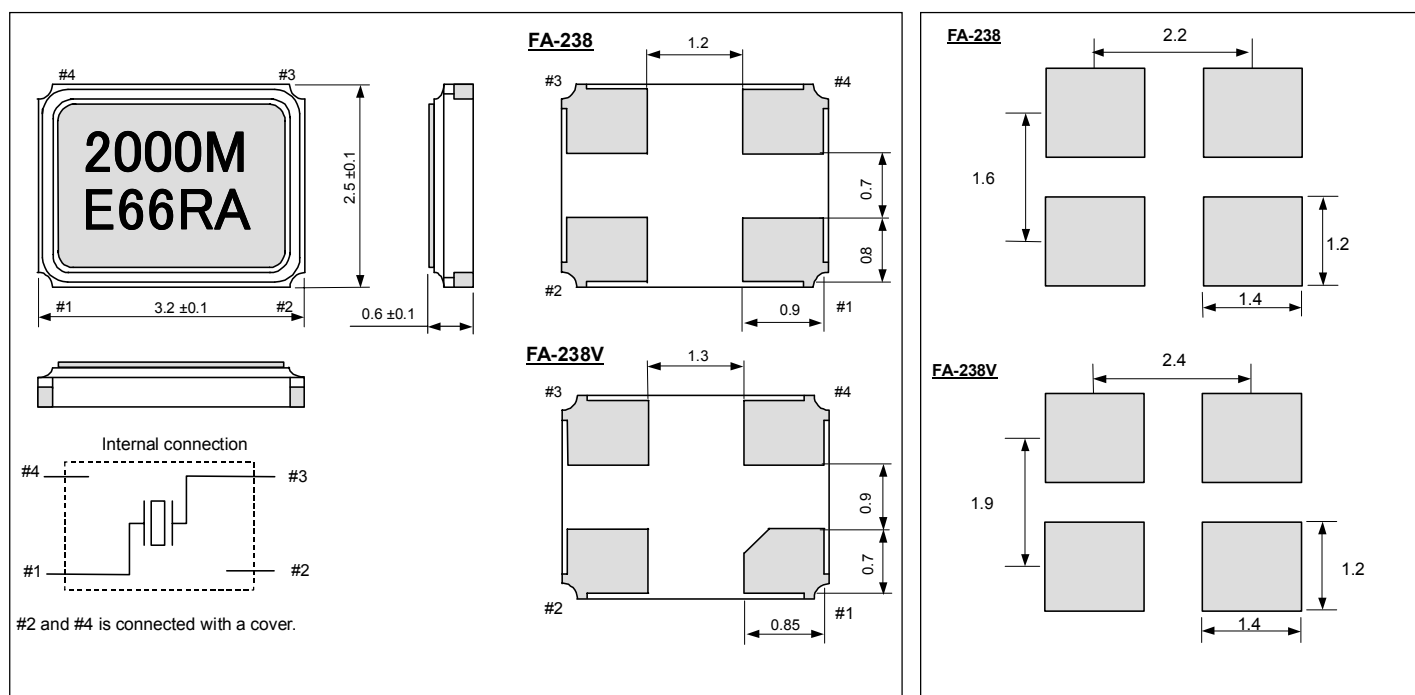

THIN SMD HIGH-STABILITY CRYSTAL UNIT

FA-23H

Product number (please contact us)
Q24FA23H0xxxx00

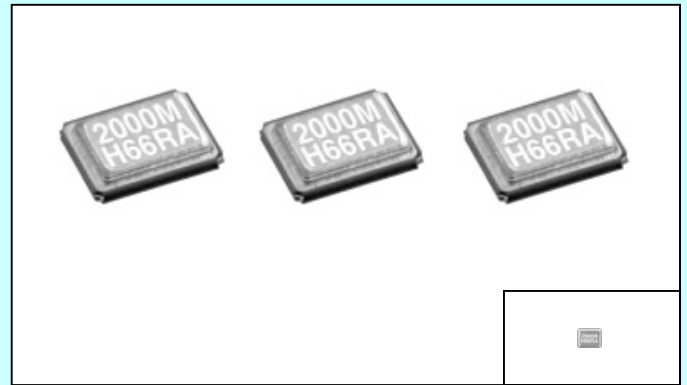

Actual size

- Frequency range : 16 MHz to 32 MHz
- Thickness : 0.6 mm Typ.
- Overtone order : Fundamental
- Applications : Bluetooth and GSM and W – LAN
 (Sensitivity 26 MHz:
 $18 \times 10^{-6}/\text{pF}$ at 10 pF (Typ.))
- Lead(Pb)-free : Complies with EU RoHS directive
 (Lead free completely)

Specifications (characteristics)

Item	Symbol	Specifications	Remarks	
Nominal frequency range	f	16.000 MHz to 32.000 MHz	Fundamental For the out of standard specifications, please contact us for inquiries.	
Recommended applications		W-LAN / Bluetooth / GSM / Mobile communication device		
Temperature range	Storage temperature	T _{STG}	-40 °C to +125 °C	Stored as bare product after unpacking
	Operating temperature	T _{OPR}	-40 °C to +85 °C	Specified equivalent series must be satisfied
	Operable temperature	T _{USE}	As per below table	Specified equivalent series and frequency temperature characteristics must be satisfied.
Recommended drive level	DL	10 μW to 100 μW		
Frequency tolerance (standard)	Δf/f	±10 × 10 ⁻⁶	T _a = +25 °C For the out of standard specifications, please contact us for inquiries.	
Frequency temperature characteristics (standard)		±10 × 10 ⁻⁶ (For the out of standard specifications, please as per below table)	-20 °C to +70 °C For the out of standard specifications, please contact us for inquiries.	
Load capacitance	CL	10 pF (standard)	For the out of standard specifications, please contact us for inquiries.	
Series resistance	R ₁	As per below table	Operable temperature range, DL = 100 μW	
Shunt capacitance	C ₀	5 pF Max.		
Insulation resistance	IR	500 MΩ Min.		
Aging	fa	±1 × 10 ⁻⁶ / year Max.	T _a = +25 °C, first year	

Standard frequency (MHz)	16	16.384	17.56	18.432	19.2	19.5	19.68	19.8	20	21.06	22
	23.92	24	24.5535	24.576	25	26	27	30	32		

Frequency temperature characteristics

Operable temperature	Available Frequency tolerance
0 °C to +50 °C	Over than ± 5 × 10 ⁻⁶
-10 °C to +60 °C	Over than ± 7 × 10 ⁻⁶
-20 °C to +70 °C	Over than ±10 × 10 ⁻⁶
-30 °C to +80 °C	Over than ±15 × 10 ⁻⁶
-40 °C to +85 °C	Over than ±20 × 10 ⁻⁶

Series resistance (R1)

Frequency	Series resistance
16.0 MHz ≤ f < 20.0 MHz	80 Ω Max.
20.0 MHz ≤ f < 25.0 MHz	60 Ω Max.
25.0 MHz ≤ f < 30.0 MHz	50 Ω Max.
30.0 MHz ≤ f ≤ 32.0 MHz	40 Ω Max.

External dimensions

(Unit:mm) ■ Recommended soldering pattern (Unit:mm)

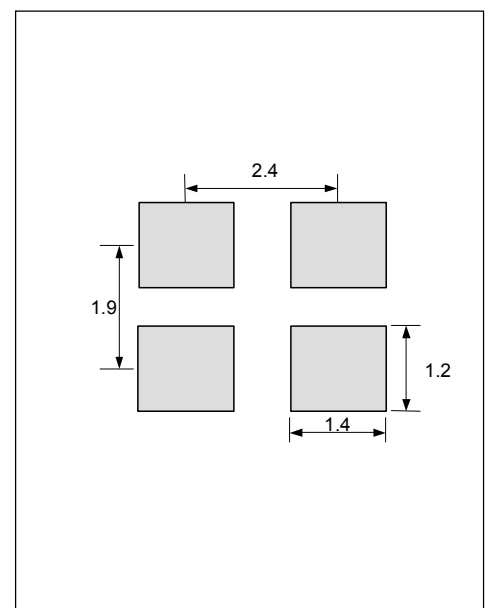
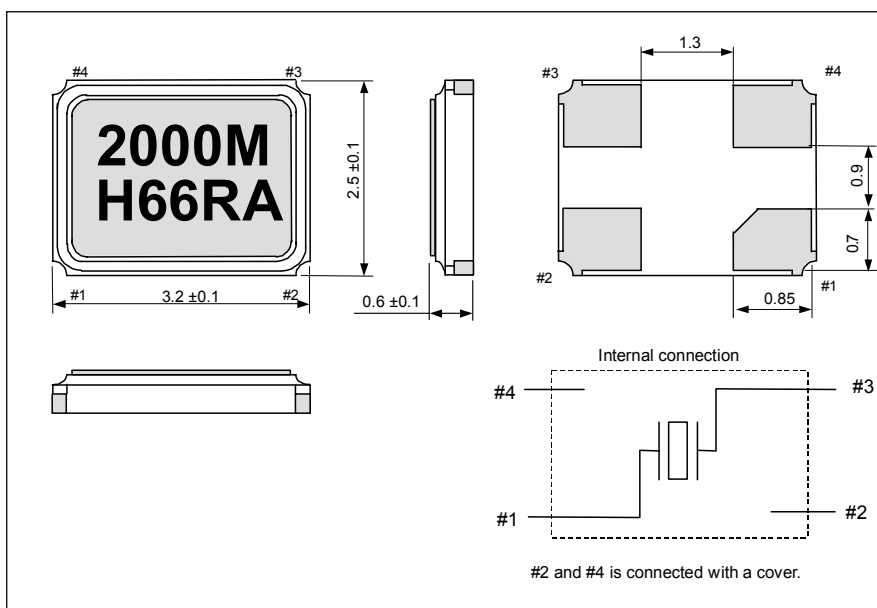

THIN SMD HIGH-FREQUENCY CRYSTAL UNIT

FA-365

Product number (please contact us)
Q22FA3650xxxx00

- Frequency range : 12 MHz, 14 MHz to 41 MHz
- Thickness : 1.4 mm Max.
- Overtone order : Fundamental
- Applications : For Clock of integrated circuit
- Lead(Pb)-free : Complies with EU RoHS directive

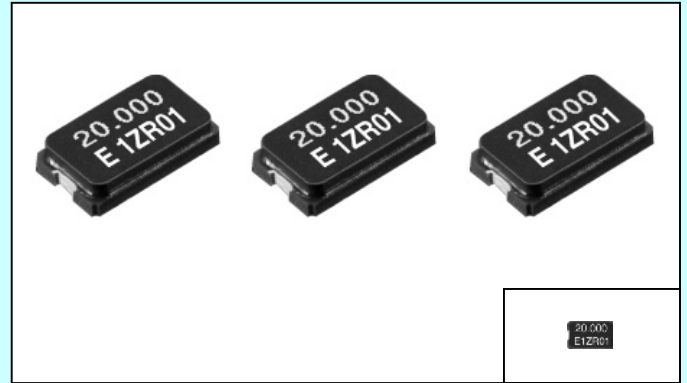

Actual size

■ Specifications (characteristics)

Item	Symbol	Specifications	Remarks
Nominal frequency range	f	12.000 MHz, 14.000 MHz to 41.000 MHz	Fundamental
Temperature range	Storage temperature	T _{STG}	-55 °C to +125 °C
	Operating temperature	T _{OPR}	-20 °C to +70 °C
Recommended drive level	DL	10 μW to 100 μW	Please contact us on availability of -40 °C to +85 °C
Frequency tolerance (standard)	Δf/f	±50 × 10 ⁻⁶ , ±100 × 10 ⁻⁶	T _a =+25 °C±3 °C
Frequency temperature characteristics (standard)		±30 × 10 ⁻⁶	-20 °C to +70 °C For the out of standard specifications, please contact us for inquires
Load capacitance	C _L	10 pF to ∞	Please specify
Series resistance	R ₁	60 Ω Max.(12.000 MHz)	-20 °C to +70 °C, DL=100 μW
		50 Ω Max.(14.000 MHz to 41.000 MHz)	
Shunt capacitance	C ₀	5 pF Max.	
Insulation resistance	IR	500 MΩ Min.	
Aging	f _a	±5 × 10 ⁻⁶ / year Max.	T _a =+25 °C ±3 °C ,first year
Shock resistance	S.R.	±10 × 10 ⁻⁶ Max.	Three drops on a hard board from 750 mm or excitation test with 29400 m/s ² × 0.3 ms × 1/2 sine wave x 3 directions

■ External dimensions

(Unit:mm)

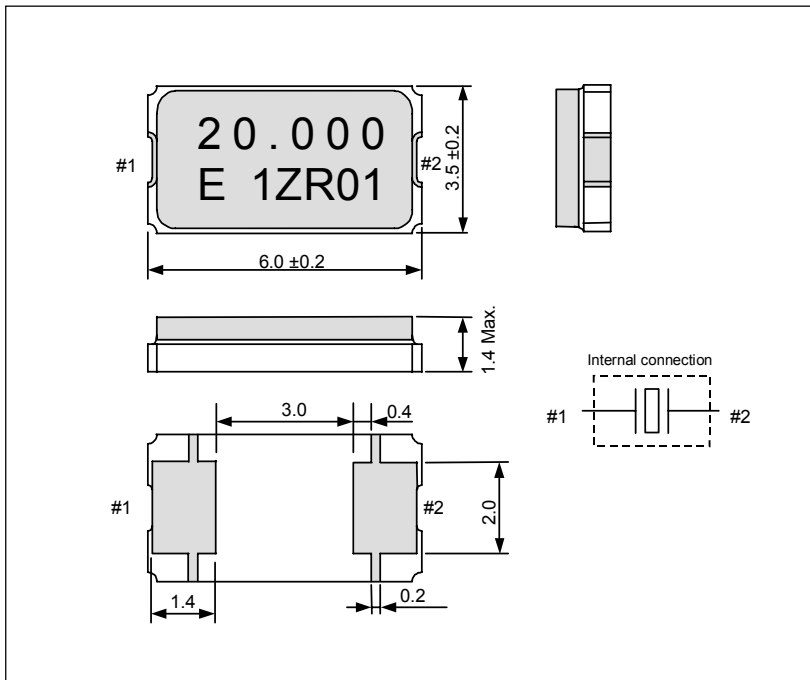

■ Recommended soldering pattern

(Unit:mm)

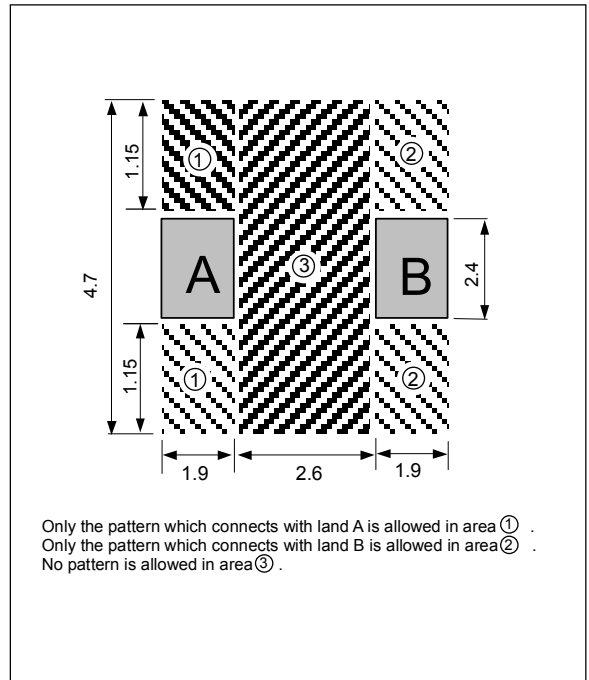

SMALL SMD HIGH - FREQUENCY CRYSTAL UNIT

MA-306

Product number (please contact us)
Q22MA3061xxxx00

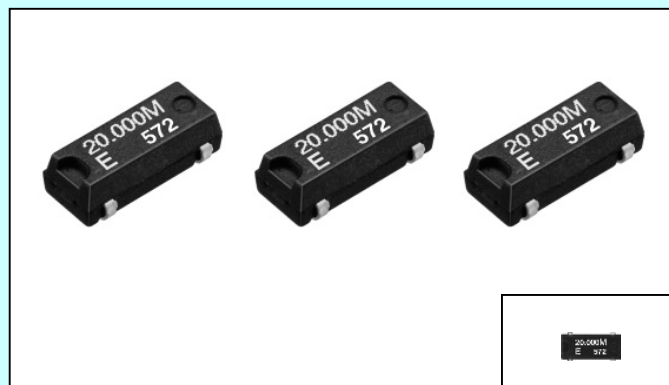

Actual size

- Frequency range : 14.31818 MHz
17.734 MHz to 41 MHz
- Thickness : 2.54 mm Max.
- Overtone order : Fundamental
- Applications : For Clock of integrated circuit
- Lead(Pb)-free : Complies with EU RoHS directive

Specifications (characteristics)

Item	Symbol	Specifications	Remarks	
Nominal frequency range	f	14.31818 MHz, 17.734 MHz to 41.000 MHz	Fundamental	
Temperature range	Storage temperature	T _{STG}	-55 °C to +100 °C	Stored as bare product after unpacking
	Operating temperature	T _{OPR}	-20 °C to +70 °C	
Recommended drive level	GL	10 μW to 100 μW		
Frequency tolerance (standard)	Δf/f	±50 × 10 ⁻⁶	T _a =+25 °C±3 °C	
Frequency temperature characteristics (standard)		±30 × 10 ⁻⁶	-20 °C to +70 °C	
Load capacitance	CL	10 pF to ∞	Please specify	
Series resistance	R ₁	60 Ω Max.	-20 °C to +70 °C,DL=100 μW	
Shunt capacitance	C ₀	5 pF Max.		
Insulation resistance	IR	500 MΩ Min.		
Aging	fa	±5 × 10 ⁻⁶ / year Max.	T _a =+25 °C ±3 °C ,first year	
Shock resistance	S.R.	±10 × 10 ⁻⁶ Max.	Three drops on a hard board from 750 mm or excitation test with 29400 m/s ² × 0.3 ms × 1/2 sine wave × 3 directions	

External dimensions

(Unit:mm)

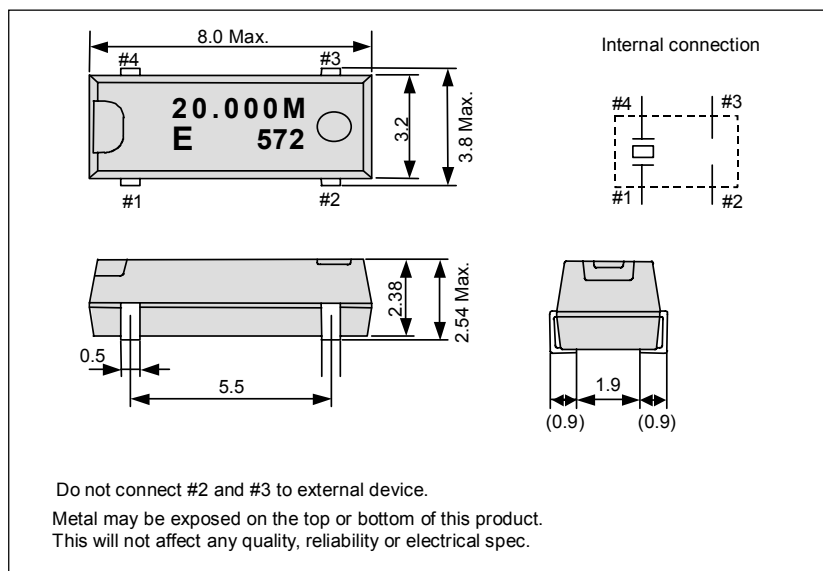

Recommended soldering pattern

(Unit:mm)

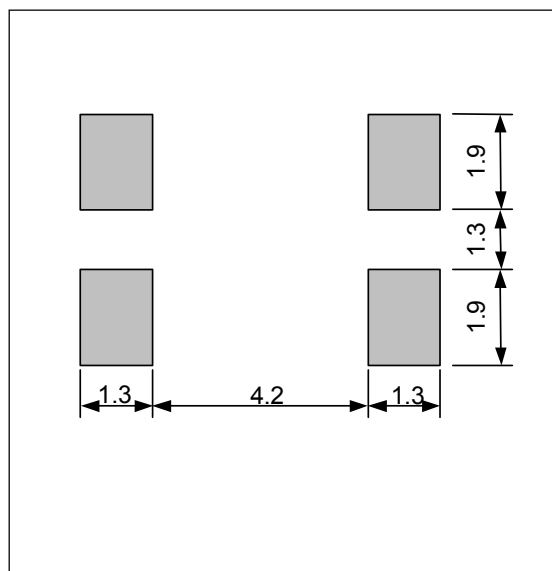

SMD HIGH-FREQUENCY CRYSTAL UNIT

MA-406 / 505 / 506

Product number (please contact us)

MA-406 : Q22MA4061xxxx00

MA-505 : Q22MA5051xxxx00

MA-506 : Q22MA5061xxxx00

- Frequency range : 4 MHz to 64 MHz
- Thickness : 3.7 mm Max.(MA-406)
4.6 mm Max.(MA-505/506)
- Overtone order : Fundamental
3rd overtone(30 MHz to 64 MHz)
- Applications : For Clock of integrated circuit
- Lead(Pb)-free : Complies with EU RoHS directive

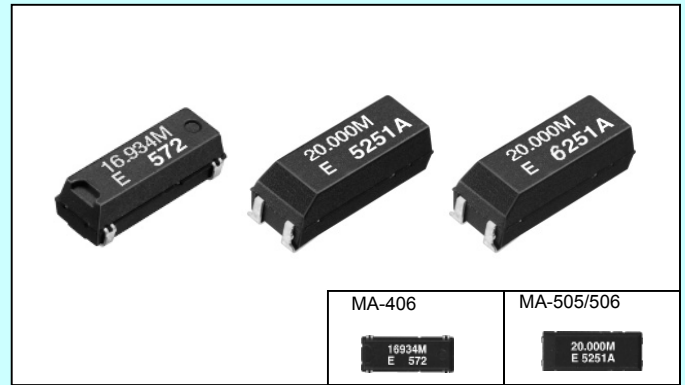

Actual size

■ Specifications (characteristics)

Item	Symbol	Specifications	Remarks
Nominal frequency range	f	4.000 MHz to 29.999 MHz 30.000 MHz to 64.000 MHz	Fundamental *1 3rd overtone *2
Temperature range	Storage temperature	T _{STG} -55 °C to +125 °C	Stored as bare product after unpacking Please contact us on availability of -40 °C to +85 °C
	Operating temperature	T _{OPR} -20 °C to +70 °C	
Recommended drive level	GL	10 μW to 100 μW	
Frequency tolerance (standard)	Δf/f	±50 × 10 ⁻⁶	T _a =+25 °C ±3 °C
Frequency temperature characteristics (standard)		Under 5.5 MHz : ±50 × 10 ⁻⁶	-20 °C to +70 °C
		Over 5.5 MHz : ±30 × 10 ⁻⁶	For the out of standard specifications, please contact us for inquires
Load capacitance	C _L	Fundamental: 10 pF to ∞ Overtone: 5 pF to ∞	Please specify
Series resistance	R ₁	As per below table	-20 °C to +70 °C, DL=100 μW
Shunt capacitance	C ₀	5 pF Max.	
Insulation resistance	IR	500 MΩ Min.	
Aging	f _a	±5 × 10 ⁻⁶ / year Max.	T _a =+25 °C ±3 °C, first year
Shock resistance	S.R.	±10 × 10 ⁻⁶ Max.	Three drops on a hard board from 750 mm or excitation test with 29400 m/s ² x 0.3 ms x 1/2 sine wave x 3 directions

*1 4.0 MHz ≤ f < 5.5 MHz : See "Available frequencies form 4.0 MHz to less than 5.5 MHz". 8.0 MHz < f < 8.2 MHz: Unavailable.

*2 26.000 MHz ≤ f < 30.000 MHz : please contact us for inquiries for 3rd overtone mode.

■ Available frequency from 4.0 MHz to less than 5.5 MHz (MHz)

4.000	4.032	4.096	4.190	4.194304	4.433619	4.500	4.800	4.9152
-------	-------	-------	-------	----------	----------	-------	-------	--------

■ Series resistance (R₁)

Frequency (MHz)	4.0 ≤ f < 5.5	5.5 ≤ f < 6.0	6.0 ≤ f < 10.0	10.0 ≤ f < 12.0	12.0 ≤ f < 16.0	16.0 ≤ f < 30.0	30.0 ≤ f ≤ 36.0	36.0 < f ≤ 64.0
Series resistance	150 Ω Max.	100 Ω Max.	80 Ω Max.	60 Ω Max.	50 Ω Max.	40 Ω Max.	100 Ω Max.	80 Ω Max.
Overtone order	Fundamental						3rd overtone	

■ External dimensions

(Unit:mm)

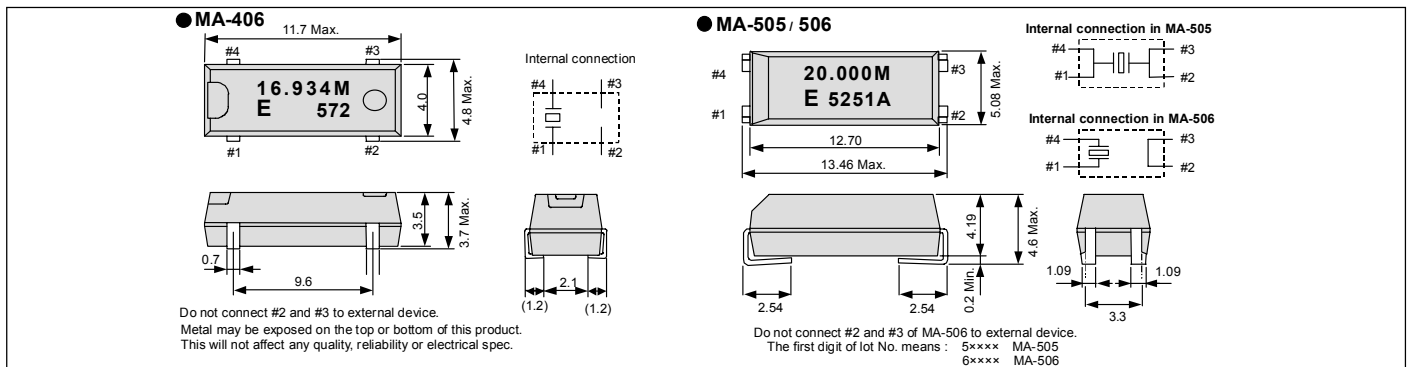

■ Recommended soldering pattern

(Unit:mm)

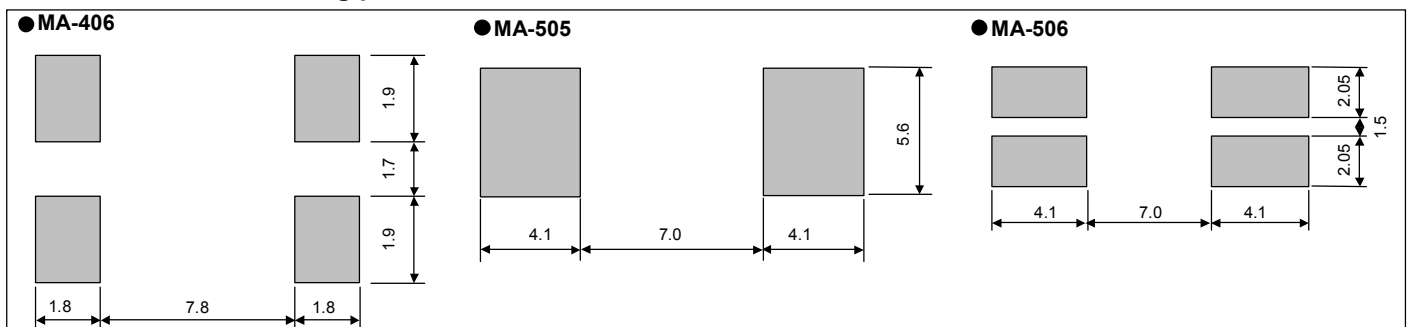

CYLINDER HIGH-FREQUENCY CRYSTAL UNIT

CA-301

Product number (please contact us)
Q21CA3011xxxx00

- Frequency range : 4 MHz to 64 MHz
- Thickness : Ø3.1 mm Max.
- Overtone order : Fundamental
3rd overtone (30 MHz to 64 MHz)
- Applications : For Clock of integrated circuit
- Lead(Pb)-free : Complies with EU RoHS directive
(Lead free completely)

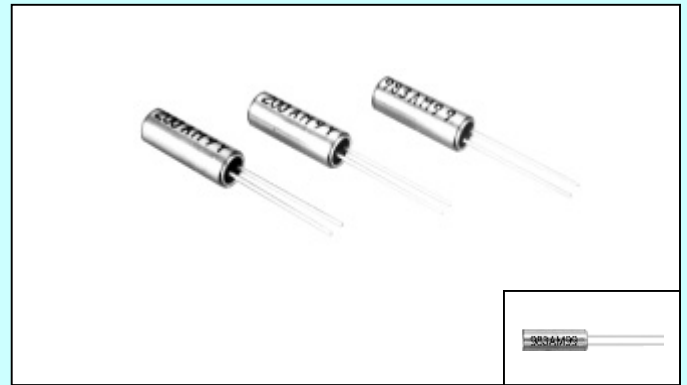

Actual size

■ Specifications (characteristics)

Item	Symbol	Specification	Remarks	
Nominal frequency range	f	4.000 MHz to 29.999 MHz	Fundamental *1	
		30.000 MHz to 64.000 MHz	3rd overtone *2	
Temperature range	Storage temperature	TSTG	-40 °C to +85 °C	Stored as bare product after unpacking
	Operating temperature	TOPR	-20 °C to +70 °C	The operating temperature range is -10 °C to +60 °C for 5.5 MHz and below
Recommended drive level	GL	10 µW to 100 µW		
Frequency tolerance (standard)	Δf/f	±30 × 10 ⁻⁶ (Under 5.5 MHz: ±50 × 10 ⁻⁶ , ±100 × 10 ⁻⁶)	T _a =+25 °C ± 3 °C	
Frequency temperature characteristics(standard)		Under 5.5 MHz: ±50 × 10 ⁻⁶	-10 °C to +60 °C	
		Over 5.5 MHz: ±30 × 10 ⁻⁶	-20 °C to +70 °C	
Load capacitance	CL	Fundamental: 10 pF to ∞. Overtone: 5 pF to ∞	Please specify	
Series resistance	R1	As per below table	-20 °C to +70 °C, DL=100 µW	
Shunt capacitance	C0	5 pF Max.		
Insulation resistance	IR	500 MΩ Min.		
Aging	fa	±5 × 10 ⁻⁶ / year Max.	T _a =+25 °C ± 3 °C, first year	
Shock resistance	S.R.	±10 × 10 ⁻⁶ Max.	Three drops on a hard board from 750 mm or excitation test with 29400 m/s ² x 0.3 ms x 1/2 sine wave x 3 directions	

*1 4.0 MHz ≤ f < 5.5 MHz : See "Available frequencies form 4.0 MHz to less than 5.5 MHz". 8.0 MHz < f < 8.2 MHz: Unavailable.

*2 26.000 MHz ≤ f < 30.000 MHz :please contact us for inquiries for 3rd overtone mode.

■ Available frequency from 4.0 MHz to less than 5.5 MHz (MHz)

4.000	4.032	4.096	4.190	4.194304	4.433619	4.500	4.800	4.9152
-------	-------	-------	-------	----------	----------	-------	-------	--------

■ Series resistance (R1)

Frequency (MHz)	4.0 ≤ f < 5.5	5.5 ≤ f < 6.0	6.0 ≤ f < 10.0	10.0 ≤ f < 12.0	12.0 ≤ f < 16.0	16.0 ≤ f < 30.0	30.0 ≤ f ≤ 36.0	36.0 < f ≤ 64.0
Series resistance	150 Ω Max.	100 Ω Max.	80 Ω Max.	60 Ω Max.	50 Ω Max.	40 Ω Max.	100 Ω Max.	80 Ω Max.
Overtone order	Fundamental						3rd overtone	

■ External dimensions

(Unit:mm)

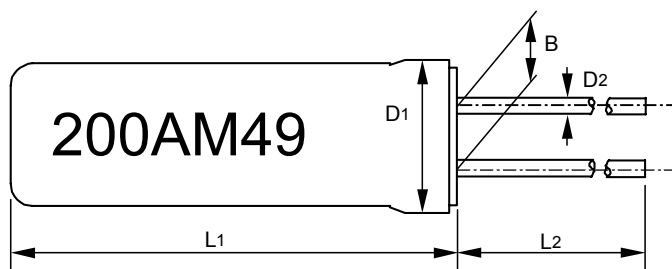

Model	L1	L2	D1	D2	B
Under 5.5 MHz	9.3 Max.	9.5 Min.	φ 3.1 Max.	φ 0.3	1.1
Over 5.5 MHz	8.9 Max.	9.5 Min.	φ 3.1 Max.	φ 0.3	1.1

HIGH-STABILITY SAW RESONATOR

NS-32R / FS-335 / 555

Product number (please contact us)

NS-32R : Q25NS32R0xxxx00

FS-335 : Q25FS3350xxxx00

FS-555 : Q25FS5550xxxx00

- Frequency range : 230 MHz to 870 MHz
- Thickness : 0.98 mm Typ.(NS-32R / FS-335)
1.50 mm Typ.(FS-555)
- Overtone order : Fundamental
- Applications : Small wireless equipment
- Lead(Pb)-free : Complies with EU RoHS directive
(Lead free completely)

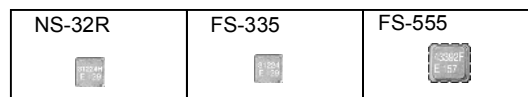
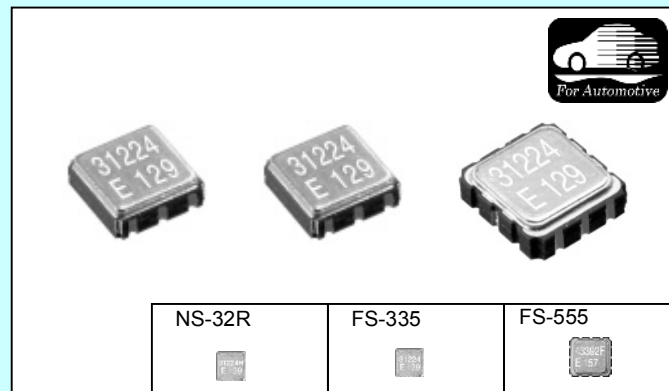

Actual size

■ Specifications (characteristics)

Item	Symbol	Specifications			Remark
		NS-32R	FS-335	FS-555	
Nominal frequency range	f	312 MHz to 870 MHz	300 MHz to 870 MHz	230 MHz to 500 MHz	Please contact us regarding available frequencies
Temperature range	Storage temperature	-40 °C to +85 °C			Stored as bare product after unpacking
	Operating temperature	-40 °C to +85 °C			
Maximum drive level	GL	10 mW Max.			NS-32R / FS-335 : f >500 MHz 2 mW Max.
Recommended drive level	DL	1 mW Typ.	2 mW Typ.		FS-335 : f >500 MHz 1 mW Typ.
Frequency tolerance (standard)	$\Delta f/f_0$	As per below table			T _a =+25 °C ±3 °C
Peak temperature	ΘT	+25 °C±20 °C			Please specify
Temperature coefficient	α	-(1.6 ±0.4) × 10 ⁻⁸ / °C ²			
Harmonic ratio	Rs/R1	2 Min.			
Series resistance	R1	As per below table			
Aging	fa	±10 × 10 ⁻⁶ / year Max.			T _a =+25 °C ±3 °C
Shock resistance	S.R.	±10 × 10 ⁻⁶ Max.			Nine drops on a concrete from 1500 mm

■ Frequency tolerance / Series resistance

Model	Item	312 MHz to 500 MHz	500 MHz to 870 MHz		
NS-32R	Frequency tolerance (standard)	±50 × 10 ⁻⁶ , ±100 × 10 ⁻⁶	±100 × 10 ⁻⁶		
	Series resistance	30 Ω Max.			
Model	Item	230 to 250 MHz	250 to 300 MHz	300 to 500 MHz	500 to 870 MHz
FS-335	Frequency tolerance (standard)	—	—	±25 × 10 ⁻⁶ , ±50 × 10 ⁻⁶ , ±100 × 10 ⁻⁶	±100 × 10 ⁻⁶
	Series resistance	—	—	25 Ω Max.	40 Ω Max.
FS-555	Frequency tolerance (standard)	±25 × 10 ⁻⁶ , ±50 × 10 ⁻⁶ , ±100 × 10 ⁻⁶			—
	Series resistance	40 Ω Max.	25 Ω Max.		—

■ External dimensions

(Unit:mm)

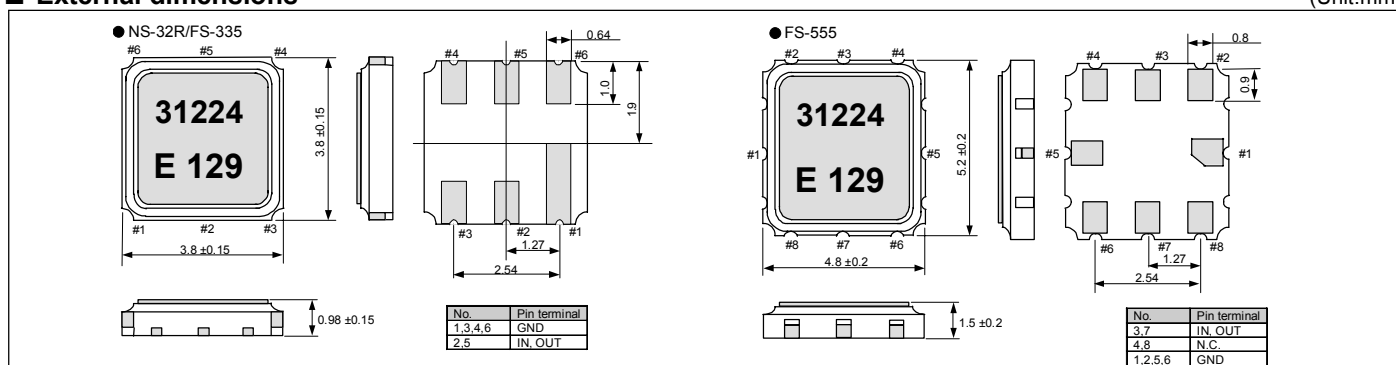

■ Recommended soldering pattern

(Unit:mm)

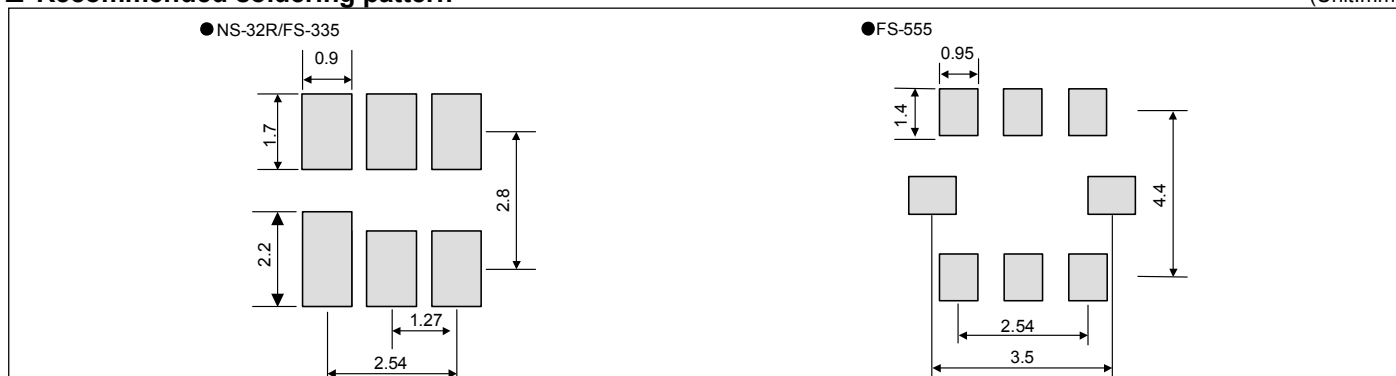

SAW RESONATOR (THE TYPE OF HIGH ENVIRONMENTAL PROCESS)
FOR TPMS

FS - 585

Product number (please contact us)
Q25FS5850xxxx00

- Frequency range : 300 MHz to 500 MHz
- Thickness : 1.5 mm Typ.
- Overtone order : Fundamental
- Applications : TPMS, Small wireless equipment
- Lead(Pb)-free : Complies with EU RoHS directive (Lead free completely)

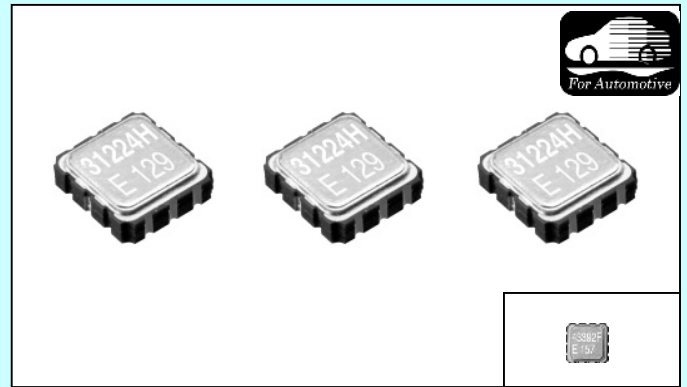

Actual size

Specifications (characteristics)

Item	Symbol	Specifications	Remarks	
Nominal frequency range	f	300 MHz to 500 MHz	Please contact us for inquiries about the available frequency.	
Temperature range	Storage temperature	T _{STG}	-40 °C to +125 °C	Stored as bare product after unpacking
	Operating temperature	T _{OPR}	-40 °C to +120 °C	
Maximum drive level	GL	10 mW Max.		
Recommended drive level	DL	2 mW Typ.		
Frequency tolerance (standard)	Δf/fo	±50 × 10 ⁻⁶ , ±100 × 10 ⁻⁶	T _a =+25 °C ±3 °C	
Peak temperature	Θ _T	+40 °C ±10 °C	Please contact us for inquiries about Peak temperature	
Temperature coefficient	α	-(3.4 ^{+0.8} / _{-0.8}) × 10 ⁻⁸ / °C ²		
Harmonic ratio	R _s / R ₁	2 Min.		
Series resistance	R ₁	18 Ω Max.		
Aging	fa	±10 × 10 ⁻⁶ / year Max.	T _a =+25 °C ±3 °C	
Shock resistance	S.R.	±10 × 10 ⁻⁶ Max.	Nine drops on a concrete from 1500 mm	

External dimensions

(Unit:mm)

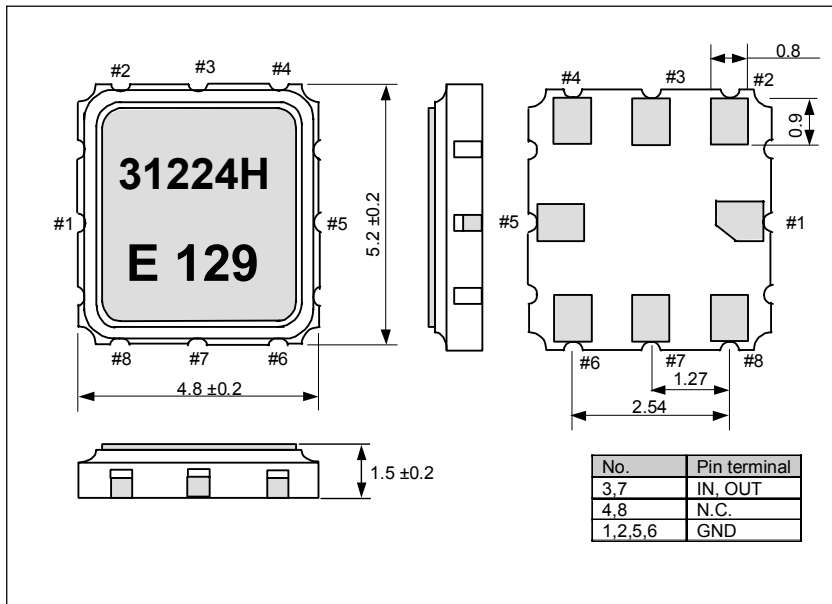

Recommended soldering pattern (Unit:mm)

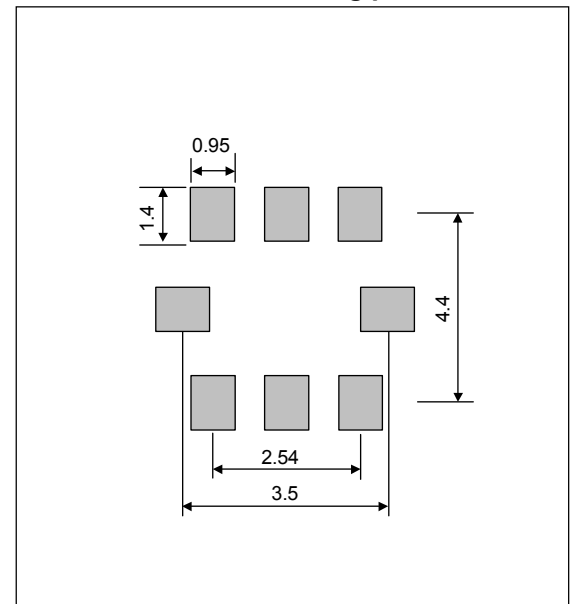

32.768kHz CRYSTAL OSCILLATOR

SG-3030LC / JF / JC
SG-3040LC / JC
SG-3032JC

Product number (please contact us)

- SG-3030LC : Q3102LC00xxxx00
- SG-3030JF/JC : Q3102JF01xxxx00 / Q3102JC01xxxx00
- SG-3040LC/JC : Q3103LC00xxxx00 / Q3103JC01xxxx00
- SG-3032JC : Q3101JC01xxxx00

- No adjustment required with 32.768 kHz crystal unit built-in.
- Use of C-MOS IC enables reduction of current consumption.
- V_{IO} controls swing amplitude (SG-3030 / SG-3040).
- Complies with EU RoHS directive

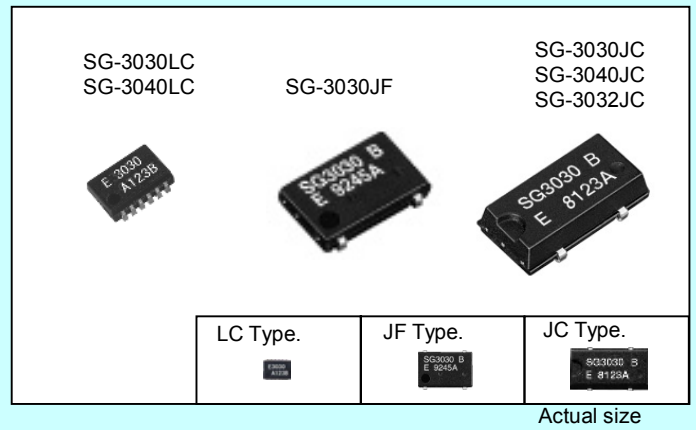

■ Specifications (characteristics)

Item	Symbol	Specifications			Remarks
		SG-3030LC / JF / JC	SG-3040LC / JC	SG-3032JC	
Output frequency range	f ₀	32.768 kHz			
Operating voltage	V _{DD}	1.5 V to 5.5 V	0.9 V to 3.6 V	1.8 V to 3.6 V	
Interface power supply voltage	V _{IO}	1.5 V to 5.5 V	0.9 V to 3.6 V	—	
Temperature range	Storage temperature	-55 °C to +125 °C			Stored as bare product after unpacking
	Operating temperature	T _{OPR}	-40 °C to +85 °C	-20 °C to +70 °C	
Frequency tolerance	Δf/f ₀	5 ±23 × 10 ⁻⁶			T _a =+25 °C, V _{DD} =3.3 V (SG-3040: V _{DD} =1.2 V)
Frequency temperature characteristics	T _{OP}	+10 × 10 ⁻⁶ / -120 × 10 ⁻⁶			T _a =-20 °C to +70 °C (T _a =+25 °C is reference)
Frequency voltage characteristics	f/V	±2 × 10 ⁻⁶ / V Max.	±5 × 10 ⁻⁶ / V Max.	±2 × 10 ⁻⁶ / V Max.	T _a =+25 °C
Current consumption	I _{OP}	2 μA Max.	3.1 μA Max.	5 μA Max.	3.3 V, No load condition
Duty	tw/t	45 % to 55 %		40 % to 60 %	1/2 V _{DD} (V _{IO})Level (SG-3040: V _{IO} =1.2 V to 3.6 V)
High output voltage	V _{OH}	V _{IO} -0.4 V Min.		V _{DD} -0.4 V Min.	I _{OH} =-0.4 mA (SG-3040: V _{IO} =1.2 V to 3.6 V)
Low output voltage	V _{OL}	0.4 V Max.			I _{OL} = 0.4 mA (SG-3040: V _{IO} =1.2 V to 3.6 V)
Output load condition	C _L	15 pF Max.			CMOS load
Output rise and fall time	t _r / t _f	200 ns Max.	100 ns Max.		CMOS load: 20 % V _{DD} (V _{IO}) to 80 % V _{DD} (V _{IO})Level (SG-3040: V _{IO} =1.2 V to 3.6 V)
Oscillation start up time	t _{osc}	1 s Max.	3 s Max.		Time at minimum operating voltage to be 0 s T _a =+25 °C (SG-3030: V _{DD} = 2.0 V to 5.5 V)
Aging	f _a	±5 × 10 ⁻⁶ Max.			T _a =+25 °C, V _{DD} = 3.3 V, first year

Unless otherwise stated, characteristics (specifications) shown in the above table are based on the rated operating temperature and voltage condition.

■ Block diagram (SG-3030LC / JC / JF, SG3040JC / LC)

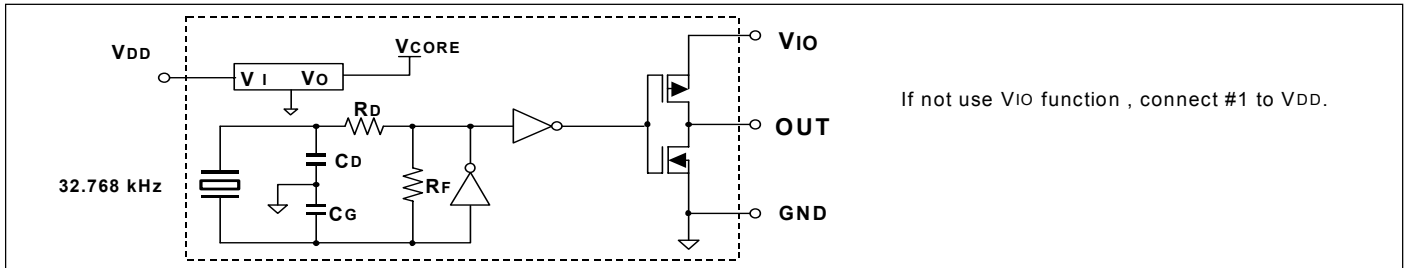

■ External dimension

(Unit:mm)

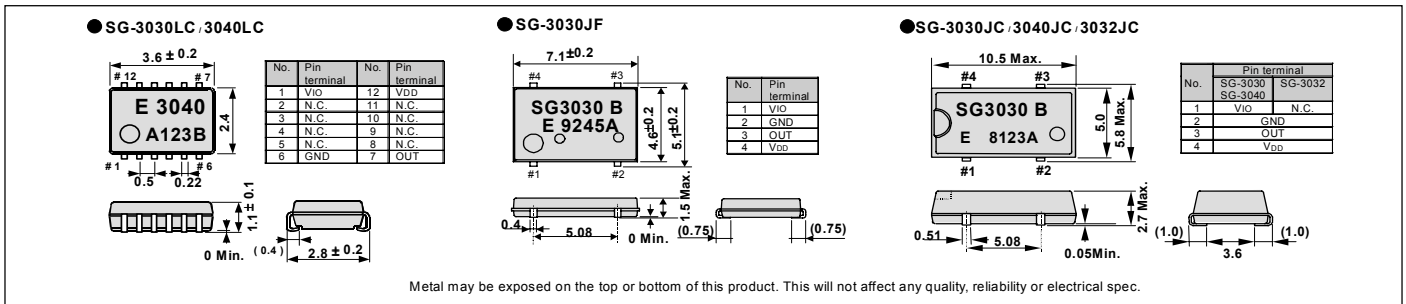

■ Recommended soldering pattern

(Unit:mm)

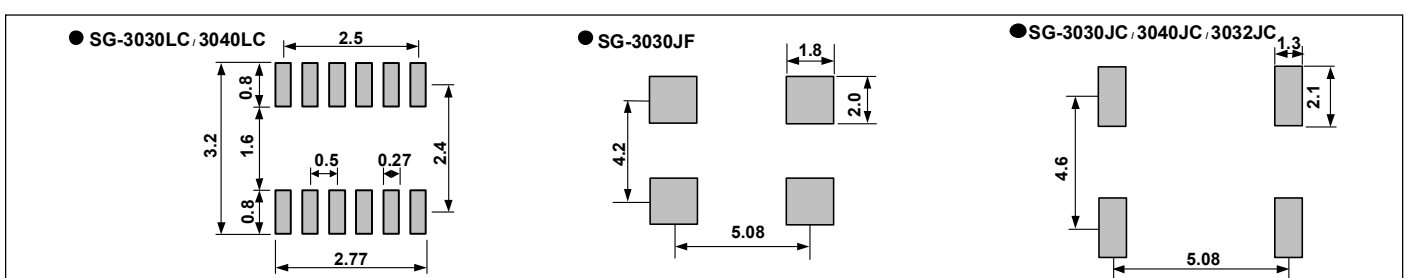

HIGH-FREQUENCY CRYSTAL OSCILLATOR

SG-310 series

Product number (please contact us)
Q33310Fx0xxxx00

- Frequency range : 2 MHz to 48 MHz
- Operating voltage : 1.8 V Typ. / 2.5 V Typ. / 3.3 V Typ.
- Current consumption : SEF1.8 V No load condition 48 MHz 1.5mA Typ.
- Function : Standby(\overline{ST})
- Thickness : 1.05 mm Typ.
- Lead(Pb)-free : Complies with EU RoHS directive (Lead free completely)

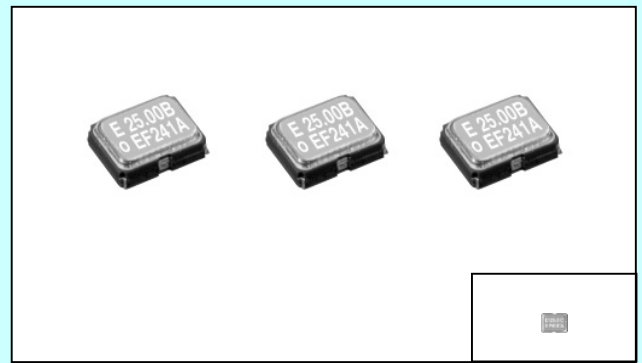

Actual size

■ Specifications (characteristics)

Item	Symbol	Specifications			Remarks
		SEF	SDF	SCF	
Output frequency range	f_0	2.000 MHz to 48.000 MHz			
Operating voltage	V_{DD}	1.8 V Typ. 1.6 V to 2.2 V	2.5 V Typ. 2.2 V to 3.0 V	3.3 V Typ. 2.7 V to 3.6 V	
Temperature range	T_{STG} T_{OPR}	-40 °C to +125 °C -40 °C to +85 °C			Stored as bare product after unpacking
Frequency stability	$\Delta f/f_0$	B: $\pm 50 \times 10^{-6}$, C: $\pm 100 \times 10^{-6}$ M: $\pm 100 \times 10^{-6}$			-20 °C to +70 °C -40 °C to +85 °C
Current consumption	I_{OP}	1.5 mA Max.	1.5 mA Max.	1.5 mA Max.	No load condition, 2 MHz $\leq f_0 \leq$ 4 MHz
		1.5 mA Max.	1.5 mA Max.	2.0 mA Max.	No load condition, 4 MHz $\leq f_0 \leq$ 8 MHz
		1.5 mA Max.	2.0 mA Max.	2.5 mA Max.	No load condition, 8 MHz $\leq f_0 \leq$ 16 MHz
		2.0 mA Max.	2.0 mA Max.	2.5 mA Max.	No load condition, 16 MHz $\leq f_0 \leq$ 25 MHz
		2.0 mA Max.	2.5 mA Max.	3.5 mA Max.	No load condition, 25 MHz $\leq f_0 \leq$ 33 MHz
Standby current	I_{ST}	0.7 μ A Max. (0.2 μ A Typ.)	1.5 μ A Max. (0.5 μ A Typ.)	2.0 μ A Max. (1.0 μ A Typ.)	$\overline{ST} = GND$
		45 % to 55 %	45 % to 55 %		2 MHz $\leq f_0 \leq$ 16 MHz 16 MHz $\leq f_0 \leq$ 33 MHz 33 MHz $\leq f_0 \leq$ 40 MHz 40 MHz $\leq f_0 \leq$ 48 MHz
Duty	tw/t	40 % to 60 %	40 % to 60 %		50 % V_{DD} $CL \leq 15$ pF
High output voltage	V_{OH}	90 % V_{DD} Min.			$I_{OH} = -3$ mA
Low output voltage	V_{OL}	10 % V_{DD} Max.			$I_{OL} = 3$ mA
Output load condition	C_L	15 pF Max.			
Output enable / disable input voltage	V_{IH}	80 % V_{DD} Min.			\overline{ST} terminal
	V_{IL}	20 % V_{DD} Max.			
Output rise and fall time	t_R / t_F	4 ns Max.			20 % V_{DD} level to 80 % V_{DD} level. $C_L = 15$ pF
Oscillation start up time	t_{osc}	10 ms Max.			$t = 0$ at 90% V_{DD}
Aging	fa	$\pm 5 \times 10^{-6}$ / year Max.			$T_a = +25$ °C, First year, $V_{DD} = 1.8V, 2.5V, 3.3V$

■ External dimensions

(Unit:mm)

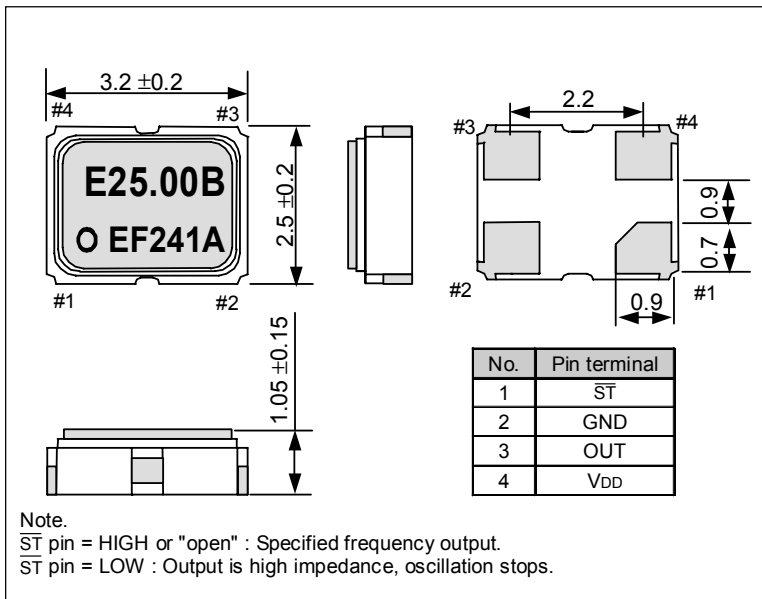

■ Recommended soldering pattern

(Unit:mm)

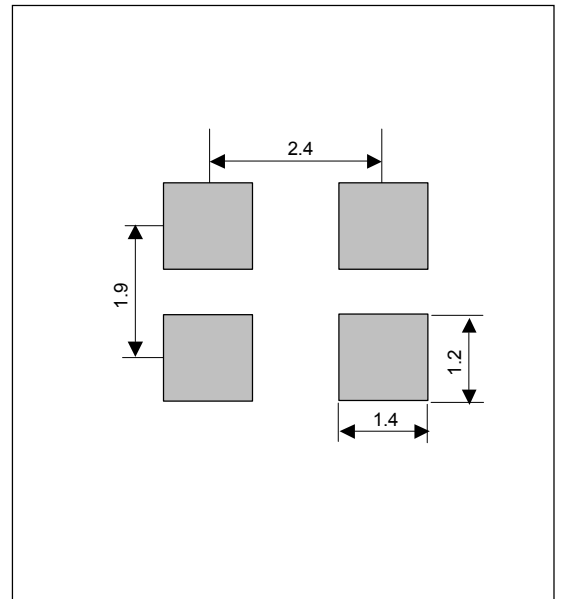

SMALL HIGH-FREQUENCY CRYSTAL OSCILLATOR

SG - 350 / 550 series

Product number (please contact us)

SG-350 : Q33350xx0xxxx00

SG-550 : Q33550xx0xxxx00

- Frequency range : 1 MHz to 48 MHz
- Operating voltage : 1.8 V Typ. / 2.5 V Typ. / 3.3 V Typ.
- Current consumption : SEF1.8 V No load condition 48 MHz 1.5 mA Typ.
- Function : Standby(\overline{ST})
- Thickness : 1.2 mm Max.
- Lead(Pb)-free : Complies with EU RoHS directive (Lead free completely)



Actual size

Specifications (characteristics)

Item	Symbol	Specifications				Remarks	
		SEF	SDF	SCF	SCG		
Output frequency range	f_0	2 MHz to 48 MHz			1 MHz to 48 MHz		
Power source voltage	Operating voltage V_{DD}	1.8 V Typ. 1.6 V to 2.2 V	2.5 V Typ. 2.2 V to 3.0 V	3.3 V Typ. 2.7 V to 3.6 V			
		Storage temperature T_{STG}	-40 °C to +125 °C				Stored as bare product after unpacking
Temperature range	Operating temperature T_{OPR}	-40 °C to +85 °C					
		Frequency stability	$\Delta f/f_0$	B: $\pm 50 \times 10^{-6}$, C: $\pm 100 \times 10^{-6}$			—
M: $\pm 100 \times 10^{-6}$				—	-40 °C to +85 °C		
—				S: $\pm 25 \times 10^{-6}$	—	-20 °C to +70 °C	
L: $\pm 50 \times 10^{-6}$				—	—	-40 °C to +85 °C	
Current consumption	I_{OP}	1.5 mA Max.	1.5 mA Max.	1.5 mA Max.	—	No load condition, 2 MHz $\leq f_0 \leq$ 4 MHz	
		1.5 mA Max.	1.5 mA Max.	2.0 mA Max.	—	No load condition, 4 MHz $\leq f_0 \leq$ 8 MHz	
		1.5 mA Max.	2.0 mA Max.	2.5 mA Max.	—	No load condition, 8 MHz $\leq f_0 \leq$ 16 MHz	
		2.0 mA Max.	2.0 mA Max.	2.5 mA Max.	—	No load condition, 16 MHz $\leq f_0 \leq$ 25 MHz	
		2.0 mA Max.	2.5 mA Max.	3.5 mA Max.	—	No load condition, 25 MHz $\leq f_0 \leq$ 33 MHz	
		3.0 mA Max.	3.5 mA Max.	4.5 mA Max.	—	No load condition, 33 MHz $\leq f_0 \leq$ 48 MHz	
Standby current	I_{ST}	—	—	—	12 mA Max.	No load condition, Max.frequency output.	
		0.7 μ A Max.	1.5 μ A Max.	2.0 μ A Max.	50 μ A Max.	$\overline{ST} = GND$	
Duty	tw/t	45 % to 55 %	45 % to 55 %		45 % to 55 %	1 MHz $\leq f_0 \leq$ 16 MHz	
		40 % to 60 %	40 % to 60 %			16 MHz $\leq f_0 \leq$ 33 MHz	
			40 % to 60 %			33 MHz $\leq f_0 \leq$ 40 MHz	
High output voltage	V_{OH}	90 % V_{DD} Min.			$V_{DD} - 0.4$ V Min.	$I_{OH} = -3$ mA(SEF, SDF, SCF), -8 mA(SCG)	
Low output voltage	V_{OL}	10 % V_{DD} Max.			0.4 V Max.	$I_{OL} = 3$ mA(SEF, SDF, SCF), 8 mA(SCG)	
Output load condition	C_L	15 pF Max.					
Output enable / disable input voltage	V_{IH}	80 % V_{DD} Min.			70 % V_{DD} Min.	\overline{ST} terminal	
	V_{IL}	20 % V_{DD} Max.					
Output rise and fall time	t_R / t_F	4 ns Max.				20 % V_{DD} level to 80 % V_{DD} level. $C_L = 15$ pF	
Oscillation start up time	t_{osc}	SG-350:2 ms Max. / SG-550:10 ms Max.			12 ms Max.	$t = 0$ at 90% V_{DD}	
Aging	fa	$\pm 5 \times 10^{-6}$ / year Max.			$\pm 10 \times 10^{-6}$ Max. 10 years	$T_a = +25$ °C, First year, $V_{DD} = 1.8V, 2.5V, 3.3V$	

External dimensions

(Unit:mm)

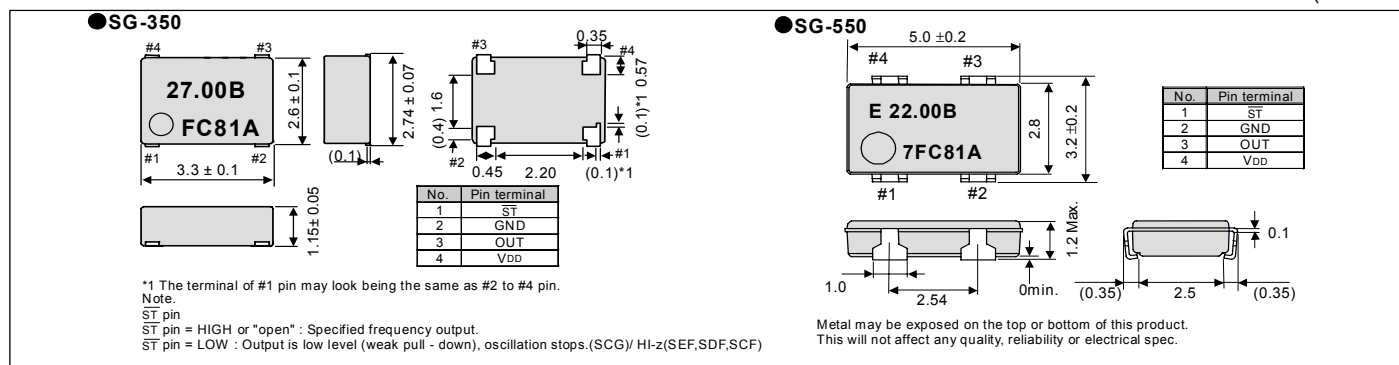

Recommended soldering pattern

(Unit:mm)

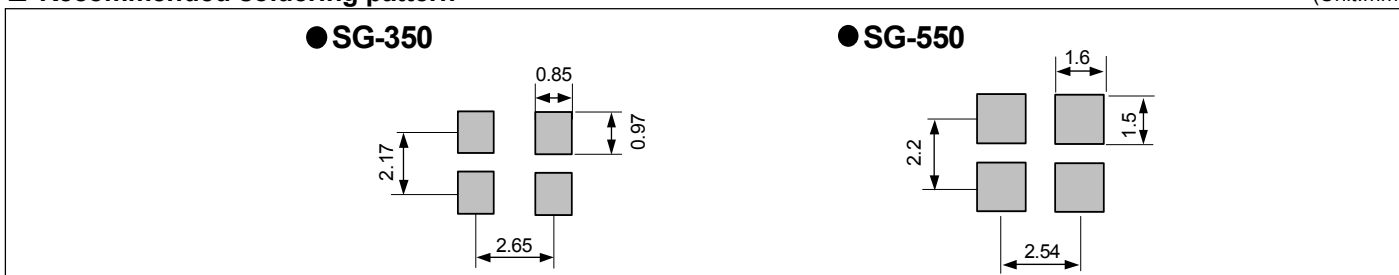

HIGH-FREQUENCY CRYSTAL OSCILLATOR

SG-710 series

Product number (please contact us)
Q33710xxxxxx00

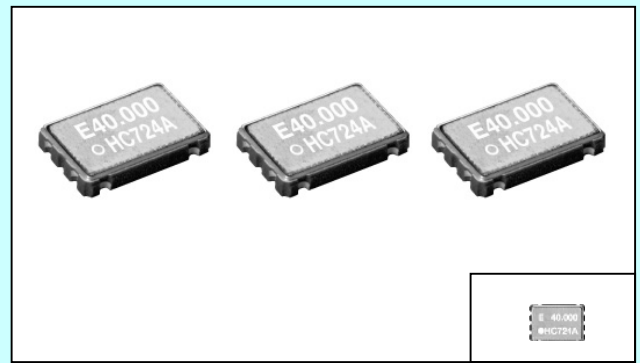

Actual size

- Frequency range : 1.8 MHz to 125 MHz
- Operating voltage : 3.3 V or 5.0 V
- Function : Output enable (OE) PTK,PHK
Standby (\overline{ST}) ECK
- Thickness : 1.3 mm Typ.
- Lead(Pb)-free : Complies with EU RoHS directive
(Lead free completely)

Specifications (characteristics)

Item	Symbol	Specifications			Remarks
		PTK	PHK	ECK	
Output frequency range	f_0	1.8 MHz to 50 MHz	1.8 MHz to 80 MHz	1.8 MHz to 125 MHz	
Operating voltage	V_{DD}	5.0 V ± 0.5 V			
Temperature range	Storage temperature	-55 °C to +125 °C			Stored as bare product after unpacking
	Operating temperature	-10 °C to +70 °C, -40 °C to +85 °C			
Frequency stability	$\Delta f/f_0$	S: $\pm 25 \times 10^{-6}$, B: $\pm 50 \times 10^{-6}$, C: $\pm 100 \times 10^{-6}$ L: $\pm 50 \times 10^{-6}$, M: $\pm 100 \times 10^{-6}$			-10 °C to +70 °C -40 °C to +85 °C
Current consumption	I_{OP}	13 mA Max.	15 mA Max.	8 mA Max.	$f_0 \leq 25$ MHz, No load condition. (ECK: $f_0 \leq 32$ MHz)
		24 mA Max.	26 mA Max.	15 mA Max.	$f_0 \leq 50$ MHz, No load condition
		—	34 mA Max.	18 mA Max.	$f_0 \leq 67$ MHz, No load condition
		—	40 mA Max.	22 mA Max.	$f_0 \leq 80$ MHz, No load condition
		—	—	30 mA Max.	$f_0 \leq 125$ MHz, No load condition
Output disable current	I_{OE}	6 mA Max.	5 mA Max.	—	$f_0 \leq 25$ MHz, OE=GND (PTK, PHK)
		12 mA Max.	10 mA Max.	—	$f_0 \leq 50$ MHz, OE=GND (PTK, PHK)
		—	13 mA Max.	—	$f_0 \leq 67$ MHz, OE=GND (PTK, PHK)
		—	16 mA Max.	—	$f_0 \leq 80$ MHz, OE=GND (PTK, PHK)
Standby current	I_{ST}	—	—	13 μ A Max.	\overline{ST} =GND(ECK)
Duty	tw/t	—	45 % to 55 %	45 % to 55 %	1.8 MHz $\leq f_0 < 50$ MHz, CL=15 pF(ECK), 50% V_{DD}
		45 % to 55 %	—	40 % to 60 %	50 MHz $\leq f_0 \leq 125$ MHz, CL=15 pF(ECK), 50% V_{DD} 1.4 V level. 10TTL
High output voltage	V_{OH}	2.4 V Min.	$V_{DD} - 0.5$ V Min.	90 % V_{DD} Min.	$I_{OH} = -16$ mA(PTK,PHK), -2 mA(ECK)
Low output voltage	V_{OL}	0.4 V Max.	0.5 V Max.	10 % V_{DD} Max.	$I_{OL} = 16$ mA(PTK,PHK), 2 mA(ECK)
Output load condition(TTL)	N	10 TTL Max.	10 TTL Max.	—	
Output load condition(CMOS)	C_L	15 pF Max.	50 pF Max.	15 pF Max.	
Output enable / disable input voltage	V_{IH}	2.0 V Min.	2.0 V Min.	70 % V_{DD} Min.	OE terminal (PTK, PHK)
	V_{IL}	0.8 V Max.	0.8 V Max.	30 % V_{DD} Max.	\overline{ST} terminal (ECK)
Output rise and fall time	t_r / t_f	—	5 ns Max.	6 ns Max.	CMOS load: 10 % V_{DD} to 90 % V_{DD} level TTL load: 0.4 V to 2.4 V level
Oscillation start up time	t_{OSC}	10 ms Max.			Time at minimum operating voltage to be 0 s
Aging	fa	$\pm 5 \times 10^{-6}$ / year Max.			$T_a = +25$ °C, $V_{DD} = 5.0$ V / 3.3 V, First year.

External dimensions

(Unit:mm) ■ Recommended soldering pattern (Unit:mm)

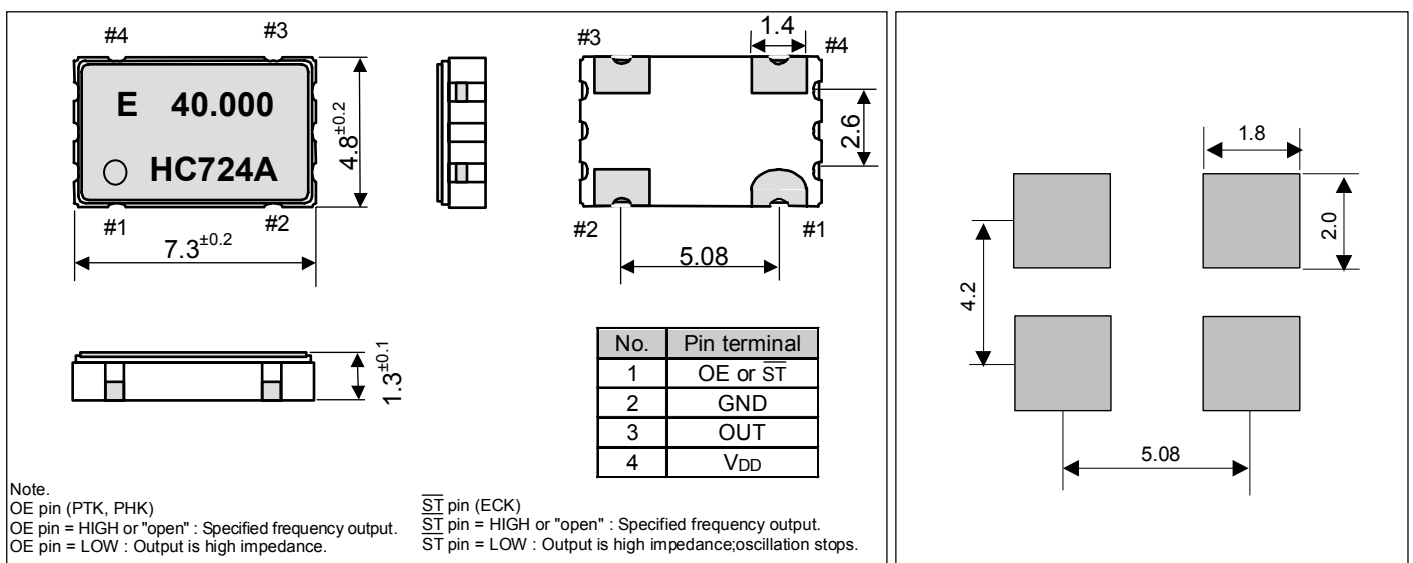

SOJ HIGH-FREQUENCY CRYSTAL OSCILLATOR

SG - 645 series

Product number (please contact us)

Q33645xx1xxxx00

- Frequency range : 32.001 MHz to 135 MHz
- Operating voltage : 3.3 V or 5.0 V
- Function : Output enable(OE) or Standby(\overline{ST})
- Thickness : 1.5 mm Max.
- Lead(Pb)-free : Complies with EU RoHS directive
- Pin compatible with ceramic package crystal oscillator (7 x 5)

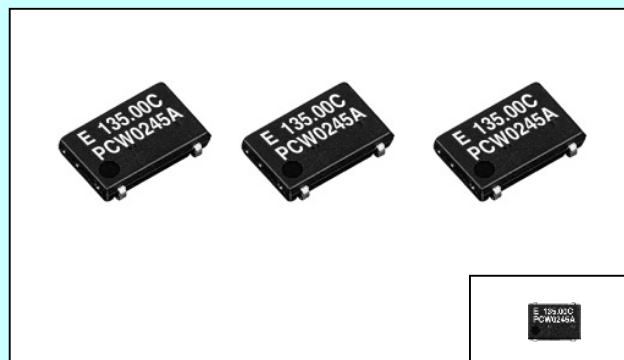

Actual size

■ Specifications (characteristics)

Item	Symbol	Specifications			Remarks
		PTW / STW	PHW / SHW	PCW / SCW	
Output frequency range	f_0	32.001 MHz to 135.000 MHz			
Operating voltage	V_{DD}	4.5 V to 5.5 V		3.0 V to 3.6 V	
Temperature range	Storage temperature	-55 °C to +125 °C			Stored as bare product after unpacking
	Operating temperature	-20 °C to +70 °C		-40 °C to +85 °C	
Frequency stability	$\Delta f/f_0$	B: $\pm 50 \times 10^{-6}$, C: $\pm 100 \times 10^{-6}$		M: $\pm 100 \times 10^{-6}$	-20 °C to +70 °C -40 °C to +85 °C
Current consumption	I_{OP}	45 mA Max.		28 mA Max.	No load condition, Max. frequency.
Output disable current	I_{OE}	30 mA Max.		16 mA Max.	OE=GND(PTW,PHW,PCW)
Standby current	I_{ST}	50 μ A Max.			\overline{ST} =GND(STW,SHW,SCW)
Duty	tw/t	—		40 % to 60 %	CMOS load: 50 % V_{DD} level, C_L =Max.
		40 % to 60 %	—		TTL load: 1.4 V level, C_L =Max.
High output voltage	V_{OH}	$V_{DD}-0.4$ V Min.			I_{OH} =-16 mA(PTW,STW,PHW,SHW), -8 mA(PCW,SCW)
Low output voltage	V_{OL}	0.4 V Max.			I_{OL} = 16 mA(PTW,STW,PHW,SHW), 8 mA(PCW,SCW)
Output load condition(TTL)	N	5TTL Max.	—		Max. frequency , Max. operating voltage.
Output load condition(CMOS)	C_L	15 pF Max.			
Output enable / disable input voltage	V_{IH}	2.0 V Min.		70 % V_{DD} Min.	OE terminal, \overline{ST} terminal
	V_{IL}	0.8 V Max.		20 % V_{DD} Max.	OE terminal, \overline{ST} terminal
Output rise and fall time	t_R / t_F	—		4 ns Max.	CMOS load: 20 % V_{DD} to 80 % V_{DD} level, $C_L \leq$ Max.
		4 ns Max.	—		TTL load: 0.4 V to 2.4 V level
Oscillation start up time	t_{OSC}	10 ms Max.			Time at minimum operating voltage to be 0 s
Aging	f_a	$\pm 5 \times 10^{-5}$ / year Max.			T_a =+25 °C, V_{DD} =5.0 V / 3.3 V, First year

■ External dimensions

(Unit:mm) ■ Recommended soldering pattern (Unit:mm)

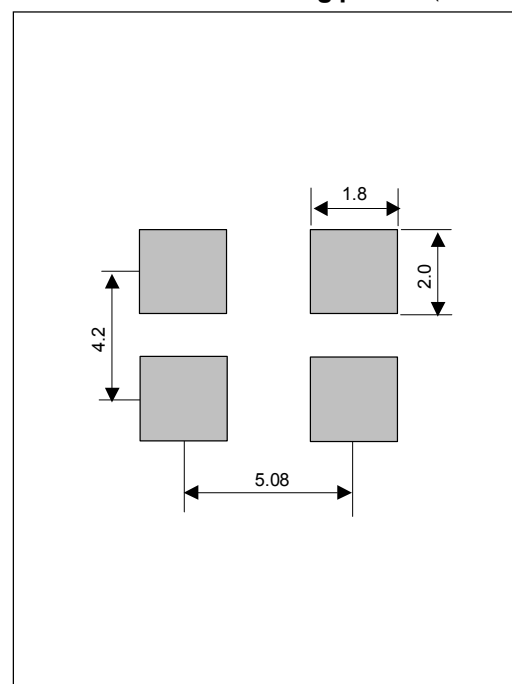
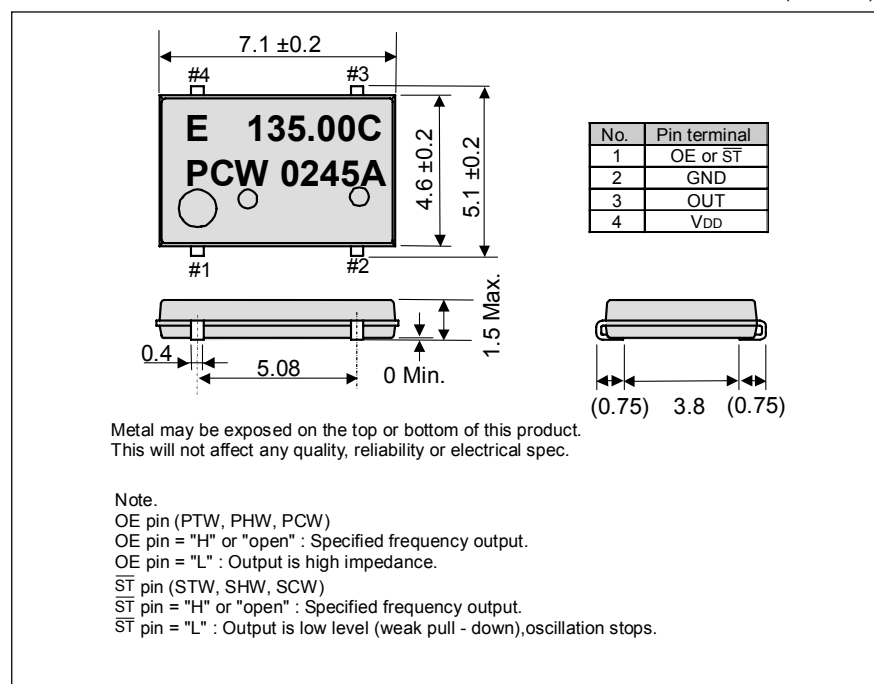

HIGH-FREQUENCY CRYSTAL OSCILLATOR

SG - 636 series

Product number (please contact us)
Q33636xx1xxxx00

- Frequency range : 2.21675 MHz to 135 MHz
- Operating voltage : 2.5 V / 3.3 V / 5.0 V
- Function : Output enable(OE) Standby(\overline{ST})
- Thickness : 2.7 mm Max.
- Lead(Pb)-free : Complies with EU RoHS directive

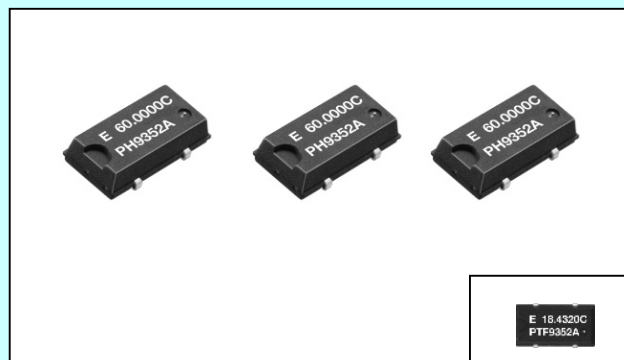

Actual size

■ Specifications (characteristics)

Item	Symbol	Specifications				Remarks
		PTF	PH	PCE / SCE	PDE	
Output frequency range	f_0	2.21675 MHz to 41.000 MHz	41.001 MHz to 70.000 MHz	2.21675 MHz to 40.000 MHz	2.21675 MHz to 40.000 MHz	
Operating voltage	V_{DD}	5.0 V \pm 0.5 V		3.3 V \pm 0.3 V	2.5 V \pm 0.25 V	
Temperature range	Storage temperature	T_{STG} -55 °C to +100 °C				Stored as bare product after unpacking
	Operating temperature	T_{OPR} -20 °C to +70 °C				
Frequency stability	$\Delta f/f_0$	C: $\pm 100 \times 10^{-6}$				
Current consumption	I_{OP}	17 mA Max.	35 mA Max.	9 mA Max.	5 mA Max.	No load condition
Output disable current	I_{OE}	10 mA Max.	20 mA Max.	5 mA Max.	3 mA Max.	OE=GND
Standby current	I_{ST}	—		2 μ A Max.	—	\overline{ST} =GND(SCE)
Duty	tw/t	40 % to 60 %		45 % to 55 %		CMOS load:50 % V_{DD} level
		45 % to 55 %		—		TTL load: 1.4 V level
High output voltage	V_{OH}	V_{DD} -0.4 V Min.				I_{OH} =8 mA(PTF)/-4 mA(PH,SCE,PCE), /-3.2 mA(PDE)
Low output voltage	V_{OL}	0.4 V Max.				I_{OL} =16 mA(PTF)/4mA(PH,SCE,PCE) /3.2 mA(PDE)
Output load condition (TTL)	N	10 TTL Max.	—			$C_L \leq 15$ pF
Output load condition (CMOS)	C_L	50 pF Max.	20 pF Max.(≤ 55 MHz) 15 pF Max.(> 55 MHz)	30 pF Max.	15 pF Max.	
Output enable / disable input voltage	V_{IH}	2.0 V Min.		80 % V_{DD} Min.		OE Terminal, \overline{ST} Terminal (SCE)
	V_{IL}	0.8 V Max.		20 % V_{DD} Max.		
Output rise and fall time	t_R / t_F	7 ns Max.	5 ns Max.			CMOS load:20 % V_{DD} to 80 % V_{DD} level
		5 ns Max.	—			
Oscillation start up time	t_{OSC}	4 ms Max.	10 ms Max.	4 ms Max.		Time at minimum operating voltage to be 0 s
Aging	fa	$\pm 5 \times 10^{-6}$ / year Max.				$T_a = +25$ °C, $V_{DD} = 5.0$ V/3.3 V/2.5 V, First year

■ Specifications (characteristics)

Item	Symbol	Specifications			Remarks	
		PTG	PHG	PCG / SCG		
Output frequency range	f_0	2.21675 MHz to 33.000 MHz *1				
Operating voltage	V_{DD}	4.5 V to 5.5 V		2.7 V to 3.6 V		
Temperature range	Storage temperature	T_{STG} -55 °C to +100 °C				Stored as bare product after unpacking
	Operating temperature	T_{OPR} -20 °C to +70 °C				
Frequency stability	$\Delta f/f_0$	B: $\pm 50 \times 10^{-6}$ C: $\pm 100 \times 10^{-6}$			-20 °C to +70 °C	
Current consumption	I_{OP}	25 mA Max.		12 mA Max.	No load condition	
Output disable current	I_{OE}	20 mA Max.		10 mA Max.	OE=GND (PTG,PHG,PCG)	
Standby current	I_{ST}	—		50 μ A Max.	\overline{ST} =GND (SCG)	
Duty	tw/t	—		45 % to 55 %	50 % V_{DD} , $C_L = 25$ pF	
		40 % to 60 %	—		1.4 V Level, $C_L = 25$ pF	
High output voltage	V_{OH}	2.4 V Min.		V_{DD} -0.4 V Min.	$I_{OH} = 8$ mA	
		—		V_{DD} -0.4 V Min.	$I_{OH} = 16$ mA	
Low output voltage	V_{OL}	—		0.4 V Max.	$I_{OL} = 8$ mA	
		0.4 V Max.		—	$I_{OL} = 16$ mA	
Output load condition	C_L	25 pF Max.				
Output enable / disable input voltage	V_{IH}	2.0 V Min.		70 % V_{DD} Min.	OE Terminal, \overline{ST} Terminal	
	V_{IL}	0.8 V Max.		20 % V_{DD} Max.		
Output rise and fall time	t_R / t_F	—		3.4 ns Max.	20 % V_{DD} to 80 % V_{DD} , $C_L \leq$ Max.	
		2.4 ns Max.	—			
Oscillation start up time	t_{OSC}	12 ms Max.			$t = 0$ at 90% V_{DD}	
Aging	fa	$\pm 5 \times 10^{-6}$ / year Max.			$T_a = +25$ °C, $V_{DD} = 5.0$ V/ 3.3 V, First year	

*1 4.1250 MHz < f_0 < 4.4336 MHz, 8.2500 MHz < f_0 < 8.8672 MHz, 16.500 MHz < f_0 < 17.7344 MHz : Unavailable

■ Specifications (characteristics)

Item	Symbol	Specifications			Remarks
		PTW / STW	PHW / SHW	PCW / SCW	
Output frequency range	f ₀	32.001 MHz to 135.000 MHz			
Operating voltage	V _{DD}	5.0 V ±0.5 V		3.3 V ±0.3 V	
Temperature range	Storage temperature	-55 °C to +100 °C			Stored as bare product after unpacking
	Operating temperature	-20 °C to +70 °C			
Frequency stability	Δf/f ₀	B: ±50 × 10 ⁻⁶ C: ±100 × 10 ⁻⁶			-20 °C to +70 °C *1
Current consumption	I _{OP}	45 mA Max.		28 mA Max.	No load condition(Max. frequency range)
Output disable current	I _{OE}	30 mA Max.		16 mA Max.	OE=GND (PTW,PHW,PCW)
Standby current	I _{ST}	50 μA Max.			ST =GND (STW,SHW,SCW)
Duty	tw/t	—		40 % to 60 %	50 % V _{DD} , C _L =Max.
		40 % to 60 %		—	1.4 V Level, C _L =Max.
High output voltage	V _{OH}	V _{DD} -0.4 V Min.			I _{OH} =-16 mA(PTW , STW , PHW , SHW)/-8 mA(PCW , SCW)
Low output voltage	V _{OL}	0.4 V Max.			I _{OL} = 16 mA(PTW , STW , PHW , SHW)/ 8 mA(PCW , SCW)
Output load condition (TTL)	N	5 TTL Max.	—	—	f ₀ ≤ 90 MHz, Max.operating voltage.
Output load condition (CMOS)	C _L	15 pF Max.			Max.frequency , Max.operating voltage.
Output enable / disable input voltage	V _{IH}	2.0 V Min.		70 % V _{DD} Min.	OE Terminal , ST Terminal
	V _{IL}	0.8 V Max.		20 % V _{DD} Max.	
Output rise and fall time	t _R / t _F	—		4 ns Max.	20 % V _{DD} to 80 % V _{DD} ,C _L ≤ Max.
		4 ns Max.		—	—
Oscillation start up time	t _{OSC}	10 ms Max.			Time at minimum operating voltage to be 0 s
Aging	fa	±5 × 10 ⁻⁶ / year Max.			T _a =+25 °C, V _{DD} =5.0 V / 3.3 V , First year

*1 "C" stability : 40<f₀≤135 MHz

■ External dimensions

(Unit:mm) ■ Recommended soldering pattern (Unit:mm)

No.	Pin terminal
1	OE or ST
2	GND
3	OUT
4	V _{DD}

Note.
 OE pin (PTF,PH,PCE,PDE,PTW,PHW,PCW,PTG,PHG,PCG)
 OE pin = "H" or "open" : Specified frequency output.
 OE pin = "L" : Output is high impedance.

ST pin (STW, SHW, SCW,SCG)
 ST pin = "H" or "open" : Specified frequency output.
 ST pin = "L" : Output is low level (weak pull - down),oscillation stops.

SCE pin (SCE)
 SCE pin = "H" or "open" : Specified frequency output.
 SCE pin = "L" : Output is low level ,oscillation stops.

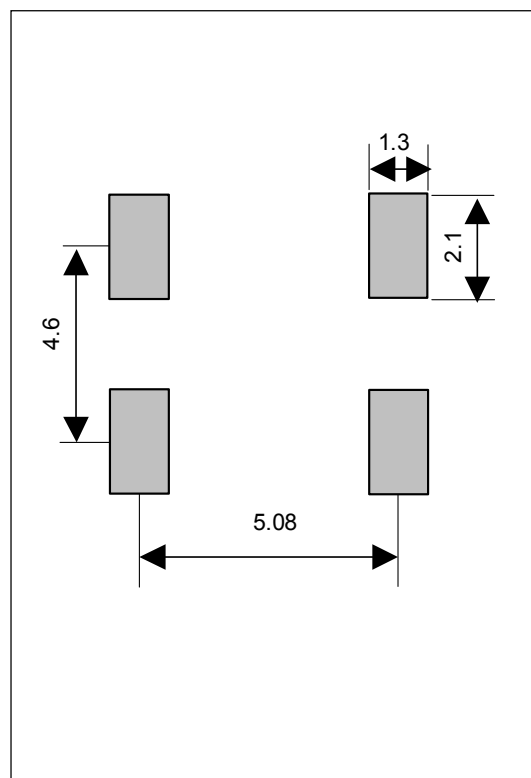

HIGH-FREQUENCY CRYSTAL OSCILLATOR

SG-615 / 531 / 51 series

Product number (please contact us)

SG-615 : Q33615xx1xxxx00

SG-531 : Q32531xx1xxxx00

SG-51 : Q32510xx1xxxx00

- Frequency range : 1.025 MHz to 135 MHz
- Operating voltage : 3.3 V / 5.0 V
- Function : Output enable(OE) Standby(\overline{ST})
- Lead(Pb)-free : Complies with EU RoHS directive
- Pin compatible with full-size metal can. (SG-51 series)
- Pin compatible with half-size metal can. (SG-531 series)

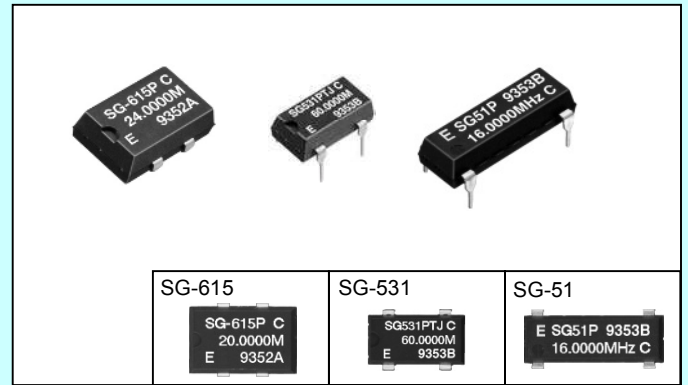

Actual size

■ Specifications (characteristics)

Item	Symbol	Specifications			Remarks
		SG-615P SG-531P SG-51P	SG-615PTJ SG-531PTJ SG-51PTJ	SG-615PH SG-531PH SG-51PH	
Output frequency range	f_0	1.0250 MHz to 26 MHz	26.001 MHz to 66.667 MHz		
Operating voltage	V_{DD}	5.0 V \pm 0.5 V			
Temperature range	Storage temperature	T_{STG} -55 °C to +125 °C			Stored as bare product after unpacking
	Operating temperature	T_{OPR} -20 °C to +70 °C			
Frequency stability	$\Delta f/f_0$	B: $\pm 50 \times 10^{-6}$, C: $\pm 100 \times 10^{-6}$			*1
Current consumption	I_{OP}	23 mA Max.	35 mA Max.		No load condition
Output disable current	I_{OE}	12 mA Max.	28 mA Max.	20 mA Max.	OE=GND
Duty	tw/t	40 % to 60 %	—	40 % to 60 %	CMOS load:50 % V_{DD} level
		40 % to 60 %	45 % to 55 %	—	TTL load: 1.4 V level
High output voltage	V_{OH}	V_{DD} -0.4 V Min.	2.4 V Min.	V_{DD} -0.4 V Min.	I_{OH} =-400 μ A(P,PTJ)/-4 mA(PH)
Low output voltage	V_{OL}	0.4 V Max.			I_{OL} =16 mA(P)/ 8 mA(PTJ)/ 4 mA(PH)
Output load condition (TTL)	N	10 TTL Max.	5 TTL Max.	—	$C_L \leq 15$ pF
Output load condition (CMOS)	C_L	50 pF Max.	—	50 pF Max.	
Output enable / disable input voltage	V_{IH}	2.0 V Min.	3.5 V Min.	2.0 V Min.	I_{IH} = 1 μ A Max. (OE= V_{DD})
	V_{IL}	0.8 V Max.	1.5 V Max.	0.8 V Max.	I_{IL} = -100 μ A Min. (OE=GND), PTJ: I_{IL} = -500 μ A Min.(OE=GND)
Output rise and fall time	t_R / t_F	8 ns Max.	—	7 ns Max.	CMOS load:20 % V_{DD} to 80 % V_{DD} level
		8 ns Max.	5 ns Max.	—	TTL load:0.4 V to 2.4 V level
Oscillation start up time	t_{OSC}	4 ms Max.	10 ms Max.		Time at minimum operating voltage to be 0 s
Aging	f_a	$\pm 5 \times 10^{-6}$ / year Max.			T_a =+25 °C, V_{DD} =5.0 V, First year

*1 "B" stability will be available up to 55 MHz.

■ Specifications (characteristics)

Item	Symbol	Specifications			Remarks
		SG-615PCG SG-531PCG	SG-615SCG SG-531SCG	SG-615PCN	
Output frequency range	f_0	1.500 MHz to 26.000 MHz		26.001 MHz to 66.667 MHz	
Operating voltage	V_{DD}	2.7 V to 3.6 V		3.0 V to 3.6 V	
Temperature range	Storage temperature	T_{STG} -55 °C to +125 °C			Stored as bare product after unpacking
	Operating temperature	T_{OPR} -40 °C to +85 °C			
Frequency stability	$\Delta f/f_0$	B: $\pm 50 \times 10^{-6}$ C: $\pm 100 \times 10^{-6}$ M: $\pm 100 \times 10^{-8}$			-20 °C to +70 °C -40 °C to +85 °C
Current consumption	I_{OP}	12 mA Max.		20 mA Max.	No load condition
Output disable current	I_{OE}	10 mA Max.	—	10 mA Max.	OE=GND (PCG,PCN)
Standby current	I_{ST}	—	50 μ A Max.	—	\overline{ST} =GND (SCG)
Duty	tw/t	45 % to 55 %			50 % V_{DD} , C_L =Max.
High output voltage	V_{OH}	V_{DD} -0.4 V Min.		V_{DD} -0.4 V Min.	I_{OH} =-8 mA
Low output voltage	V_{OL}	0.4 V Max.		0.4 V Max.	I_{OL} = 8 mA
Output load condition	C_L	25 pF Max.		15 pF Max.	
Output enable / disable input voltage	V_{IH}	70 % V_{DD} Min.		70 % V_{DD} Min.	OE Terminal, \overline{ST} Terminal
	V_{IL}	20 % V_{DD} Max.		30 % V_{DD} Max.	
Output rise and fall time	t_R / t_F	4 ns Max.			20 % V_{DD} to 80 % V_{DD} , $C_L \leq$ Max.
Oscillation start up time	t_{OSC}	12 ms Max.		10 ms Max.	$t=0$ at 90% V_{DD}
Aging	f_a	$\pm 5 \times 10^{-6}$ / year Max.			T_a =+25 °C, V_{DD} =3.3 V, First year

■ Specifications (characteristics)

Item	Symbol	Specifications			Remarks
		SG-615PTW / STW SG-531PTW / STW	SG-615PHW / SHW SG-531PHW / SHW	SG-615PCW / SCW SG-531PCW / SCW	
Output frequency range	f ₀	55.001 MHz to 135.000 MHz		26.001 MHz to 135.000 MHz	
Operating voltage	V _{DD}	5.0 V ±0.5 V		3.3 V ±0.3 V	
Temperature range	Storage temperature	-55 °C to +125 °C			Stored as bare product after unpacking
	Operating temperature	-20 °C to +70 °C		-40 °C to +85 °C	
Frequency stability	Δf/f ₀	B: ±50 × 10 ⁻⁶ , C: ±100 × 10 ⁻⁶			-20 °C to +70 °C *1
		—		M: ±100 × 10 ⁻⁶	-40 °C to +85 °C
Current consumption	I _{OP}	45 mA Max.		28 mA Max.	No load condition(Max. frequency range)
Output disable current	I _{OE}	30 mA Max.		16 mA Max.	OE=GND (PTW,PHW,PCW)
Standby current	I _{ST}	50 μA Max.			ST=GND (STW,SHW,SCW)
Duty	tw/t	—		40 % to 60 %	50 % V _{DD} , CL=Max.
		40 % to 60 %		—	1.4 V Level, CL=Max.
High output voltage	V _{OH}	V _{DD} -0.4 V Min.			I _{OH} =-16 mA(PTW,STW,PHW,SHW), -8 mA(PCW,SCW)
Low output voltage	V _{OL}	0.4 V Max.			I _{OL} = 16 mA(PTW,STW,PHW,SHW), 8 mA(PCW,SCW)
Output load condition (TTL)	N	5 TTL Max.	—	—	f ₀ ≤ 90 MHz, Max.operating voltage
Output load condition (CMOS)	CL	15 pF Max.			Max.frequency, Max.operating voltage
Output enable / disable input voltage	V _{IH}	2.0 V Min.		70 % V _{DD} Min.	OE Terminal, ST Terminal
	V _{IL}	0.8 V Max.		20 % V _{DD} Max.	
Output rise and fall time	t _R / t _F	—		4 ns Max.	20 % V _{DD} to 80 % V _{DD} , CL ≤ Max. 0.4 V to 2.4 V
		4 ns Max.		—	
Oscillation start up time	t _{osc}	10 ms Max.			Time at minimum operating voltage to be 0 s
Aging	f _a	±5 × 10 ⁻⁶ / year Max.			T _a =+25 °C, V _{DD} =5.0 V / 3.3 V, First year

*1 "C" stability :f₀ ≥66.667 MHz(PTW,STW,PHW,SHW)

■ External dimensions

(Unit:mm)

■ Recommended soldering pattern

(Unit:mm)

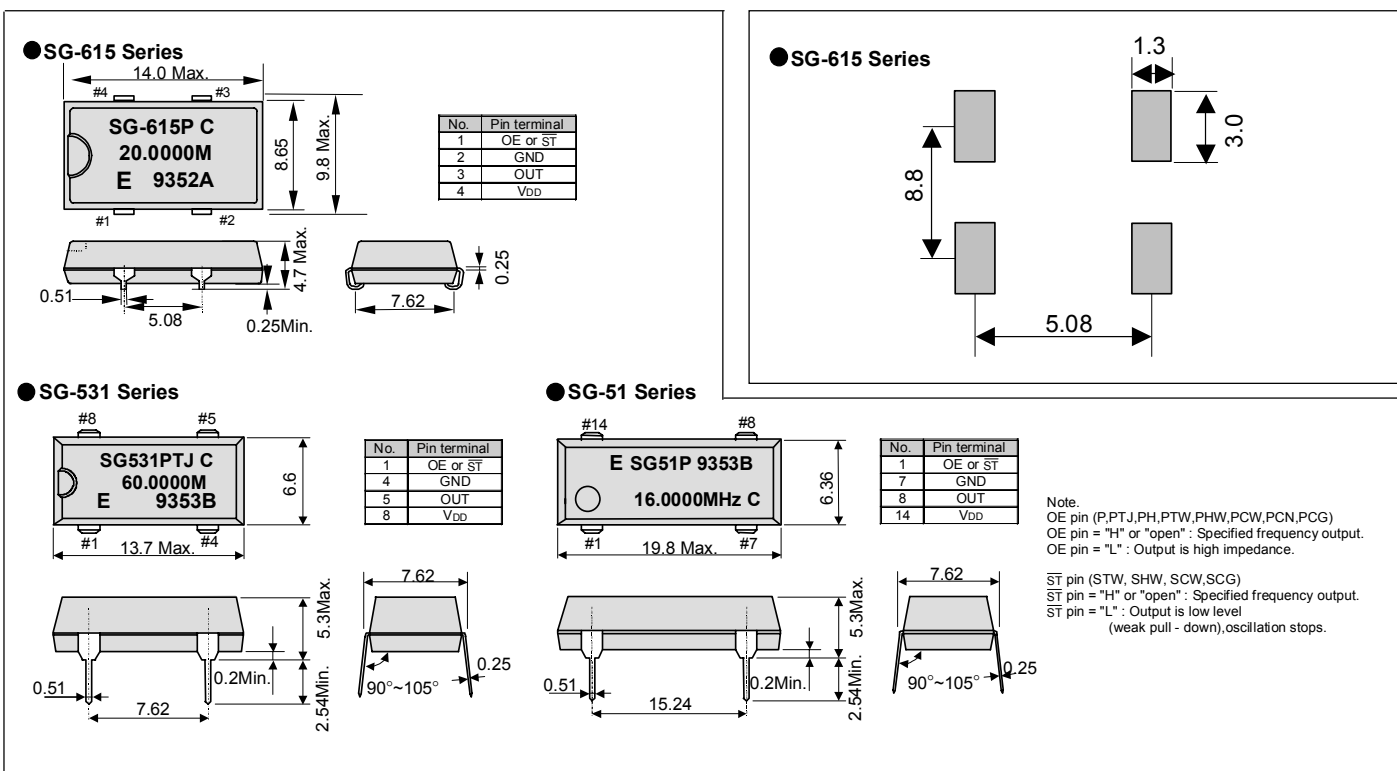

PROGRAMMABLE HIGH-FREQUENCY CRYSTAL OSCILLATOR

SG - 8002CE series

Product number (please contact us)
Q3321CEX0xxxx00

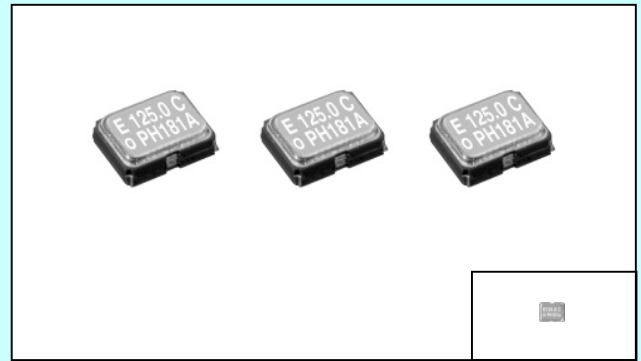

Actual Size

- Frequency range : 1 MHz to 125 MHz
 - Operating voltage : 3.3 V or 5.0 V
 - Function : Output enable(OE) or Standby(\overline{ST})
 - Thickness : 1.05 mm Typ.
 - Lead(Pb)-free : Complies with EU RoHS directive (Lead free completely)
 - Short mass production lead time by PLL technology.
 - SG-Writer available to purchase.
- Please contact EPSON or local sales representative.

Specifications (characteristics)

Item	Symbol	Specifications *2			Remarks
		PT / ST	PH / SH	PC / SC	
Output frequency range	f ₀	1 MHz to 125 MHz		—	V _{DD} =4.5 V to 5.5 V
		—		1 MHz to 125 MHz	V _{DD} =3.0 V to 3.6 V
		—		1 MHz to 66.7 MHz	V _{DD} =2.7 V to 3.6 V
Operating voltage	V _{DD}	4.5 V to 5.5 V		2.7 V to 3.6 V	
Temperature range	Storage temperature	-40 °C to +125 °C			Stored as bare product after unpacking
	Operating temperature	-20 °C to +70 °C (-40 °C to +85 °C)		-40 °C to +85 °C	Refer to Application guide. "Frequency range"
Frequency stability	Δf/f ₀	B: ±50 × 10 ⁻⁸ , C: ±100 × 10 ⁻⁸ M: ±100 × 10 ⁻⁸			B,C:-20 °C to +70 °C M:-40 °C to +85 °C *3
Current consumption	I _{OP}	40 mA Max.		28 mA Max.	No load condition, Max. frequency
Output disable current	I _{OE}	30 mA Max.		16 mA Max.	OE=GND
Standby current	I _{ST}	50 μA Max.			\overline{ST} =GND(ST,SH,SC)
Duty *1	tw/t	—		40 % to 60 %	CMOS load:50 % V _{DD} , Max. load condition
		40 % to 60 %		—	TTL load: 1.4V, Max. load condition
High output voltage	V _{OH}	V _{DD} -0.4 V Min.			I _{OH} =-16 mA(PT,ST,PH,SH), -8 mA(PC,SC)
Low output voltage	V _{OL}	0.4 V Max.			I _{OL} =16 mA(PT,ST,PH,SH), 8 mA(PC,SC)
Output load condition (TTL) *1	N	5TTL Max.	—		Max. frequency and Max. operating voltage
Output load condition (CMOS) *1	CL	15 pF Max.			
Output enable / disable input voltage	V _{IH}	2.0 V Min.		70 % V _{DD} Min.	\overline{ST} , OE terminal
	V _{IL}	0.8 V Max.		20 % V _{DD} Max.	\overline{ST} , OE terminal
Output rise fall time *1	t _R / t _F	—		3 ns Max.	CMOS load: 20 % V _{DD} to 80 % V _{DD} level
		4 ns Max.		—	TTL load: 0.4 V to 2.4 V level
Oscillation start up time	t _{osc}	10 ms Max.			Time at minimum operating voltage to be 0 s
Aging	f _a	±5 × 10 ⁻⁶ / year Max.			T _a =+25 °C, V _{DD} =5.0 V / 3.3 V (PC,SC) First year

*1 Operating temperature (-40 °C to +85 °C), the available frequency, duty and output load conditions, please refer to Page 40.

*2 PLL-PLL connection & Jitter specification, please refer to Page 41.

*3 PT / ST and PH / SH for "M" stability will be available up to 27 MHz.

External dimensions

(Unit:mm) ■ Recommended soldering pattern (Unit:mm)

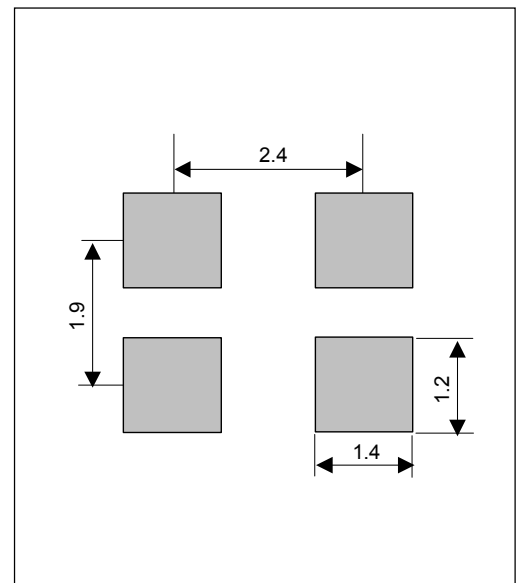
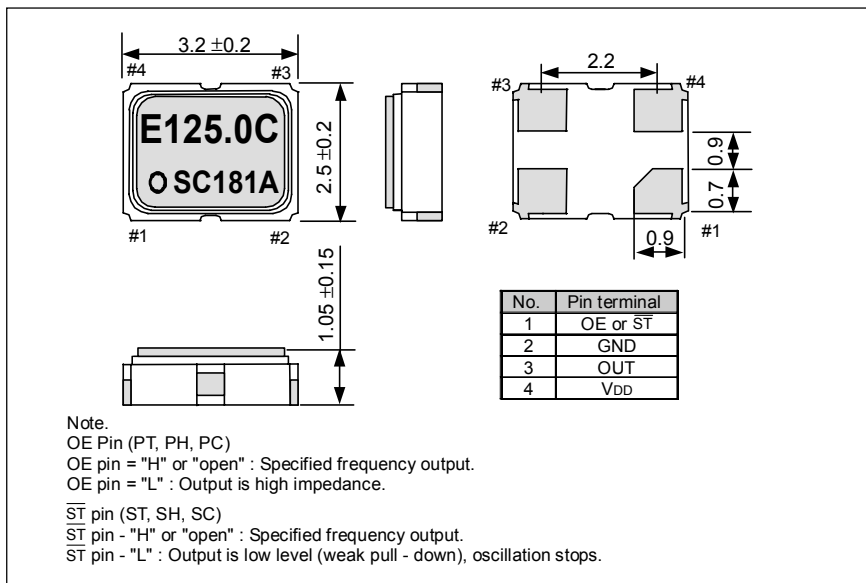

HIGH-FREQUENCY CRYSTAL OSCILLATOR

SG - 8002LA/LB series

Product number (please contact us)

SG-8002LA : Q3324LAXx0xxx00
 SG-8002LB : Q3323LBxx0xxx00

- Frequency range : 1 MHz to 125 MHz
- Operating voltage : 3.3 V or 5.0 V
- Function : Output enable(OE) or Standby(\overline{ST})
- Thickness : 1.15 mm Typ.(SG-8002LA)
- Lead(Pb)-free : Complies with EU RoHS directive (Lead free completely)
- Short mass production lead time by PLL technology.
- SG-Writer available to purchase. Please contact EPSON or local sales representative.



SG-8002LA	SG-8002LB
-----------	-----------

Actual size

Specifications (characteristics)

Item	Symbol	Specifications *2		Remarks
		PH / SH	PC / SC	
Output frequency range	fo	1 MHz to 80 MHz	—	VDD=4.5 V to 5.5 V
		—	1 MHz to 125 MHz	VDD=3.0 V to 3.6 V
		—	1 MHz to 66.7 MHz	VDD=2.7 V to 3.6 V
Operating voltage	VDD	4.5 V to 5.5 V	2.7 V to 3.6 V	
		-40 °C to +125 °C		Stored as bare product after unpacking
Temperature range	Storage temperature	-40 °C to +125 °C		
	Operating temperature	-20 °C to +70 °C (-40 °C to +85 °C)		Refer to Application guide. "Frequency range"
Frequency stability	Δf/fo	B: ±50 × 10 ⁻⁶ , C: ±100 × 10 ⁻⁶		B, C: -20 °C to +70 °C
		M: ±100 × 10 ⁻⁶ *3		M: -40 °C to +85 °C
		—	L: ±50 × 10 ⁻⁶	L: -40 °C to +85 °C VDD ±5 %
Current consumption	IOP	30 mA Max.	—	No load condition, fo=80 MHz
		—	28 mA Max.	No load condition, fo=125 MHz
Output disable current	IOE	25 mA Max.	—	P Type only, fo=80 MHz
		—	16 mA Max.	P Type only, fo=125 MHz
Standby current	IST	50 μA Max.		S Type only, ST=GND
		40 % to 60 %	—	50 % VDD, CL=15 pF, ≤80 MHz
Duty *1	tw/t	45 % to 55 %	—	50 % VDD, CL=25 pF, ≤50 MHz
		—	40 % to 60 %	50 % VDD, CL=15 pF, VDD=3.0 V to 3.6 V, ≤125 MHz
		—	40 % to 60 %	50 % VDD, CL=15 pF, VDD=2.7 V to 3.6 V, ≤66.7 MHz
High output voltage	VOH	VDD-0.4 V Min.		IOH=-16 mA(PH,SH), -8 mA(PC,SC)
		0.4 V Max.		IOH= 16 mA(PH,SH), 8 mA(PC,SC)
Low output voltage	VOL	0.4 V Max.		IOH= 16 mA(PH,SH), 8 mA(PC,SC)
		20 % VDD Max.		IOH= 16 mA(PH,SH), 8 mA(PC,SC)
Output load condition *1	CL	15 pF Max.		Max. frequency and Max. operating voltage
Output enable / disable input voltage	VIH	2.0 V Min.		ST, OE terminal
	VIL	0.8 V Max.		ST, OE terminal
Output rise and fall time *1	tr / tf	3 ns Max.		20 % VDD to 80 % VDD level, CL=Max.
Oscillation start up time	tOSC	10 ms Max.		Time at minimum operating voltage to be 0 s
Aging	fa	±5 × 10 ⁻⁶ / year Max.		Ta=+25 °C, VDD=5.0 V / 3.3 V (PC / SC) First year

*1 Operating temperature (-40 °C to +85 °C), the available frequency, duty and output load conditions, please refer to Page 40.

*2 PLL-PLL connection & Jitter specification, please refer to Page 41.

*3 PH,SH for "M" stability and "L" stability will be available up to 27 MHz.

External dimensions

(Unit:mm)

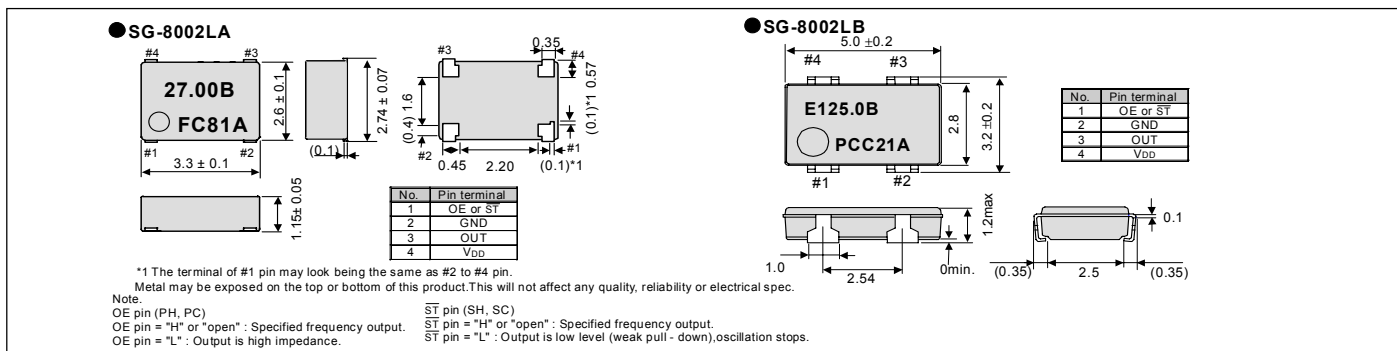

Recommended soldering pattern

(Unit:mm)

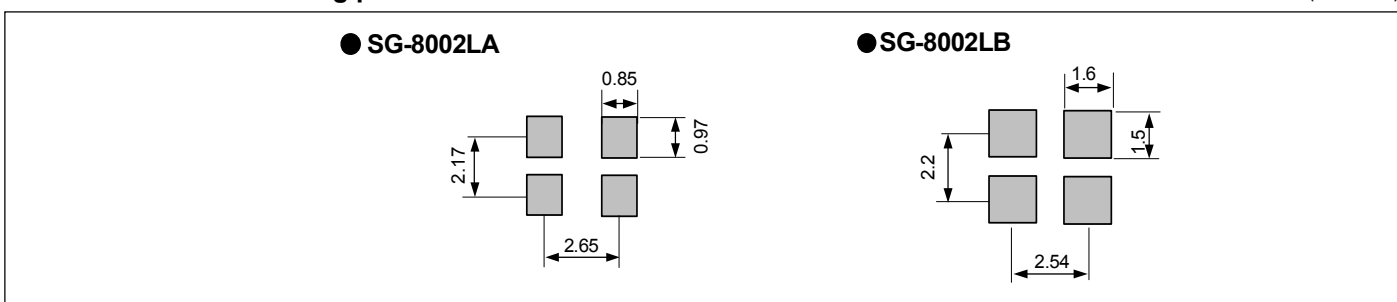

PROGRAMMABLE HIGH-FREQUENCY CRYSTAL OSCILLATOR

SG - 8002JF / CA series

Product number (please contact us)

SG-8002JF : Q3308JFxx1xxxx00
 SG-8002CA : Q3309CAxx0xxxx00

- Frequency range : 1 MHz to 125 MHz
- Operating voltage : 3.3 V or 5.0 V
- Function : Output enable(OE) or Standby(\overline{ST})
- Thickness : 1.5 mm Max.
- Lead(Pb)-free : Complies with EU RoHS directive (Lead free completely:SG-8002CA)
- Pin compatible with ceramic package crystal oscillator (7 x 5):SG-8002JF
- Short mass production lead time by PLL technology.
- SG-Writer available to purchase. Please contact EPSON or local sales representative.

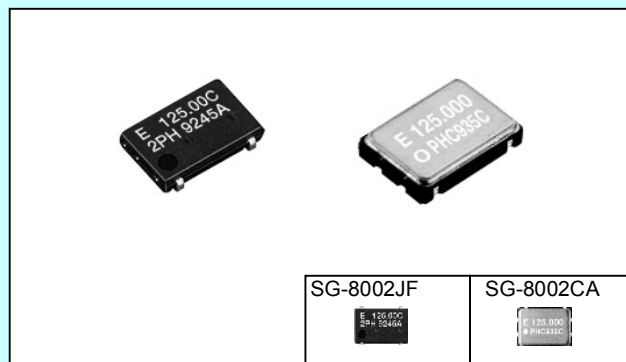

Specifications (characteristics)

Item	Symbol	Specifications *2			Remarks
		PT / ST	PH / SH	PC / SC	
Output frequency range	f_0	1 MHz to 125 MHz		—	$V_{DD}=4.5$ V to 5.5 V
Operating voltage	V_{DD}	4.5 V to 5.5 V		2.7 V to 3.6 V	$V_{DD}=3.0$ V to 3.6 V
					$V_{DD}=2.7$ V to 3.6 V
Temperature range	Storage temperature	T_{STG} -55 °C to +125 °C			Stored as bare product after unpacking
	Operating temperature	T_{OPR} -20 °C to +70 °C (-40 °C to +85 °C)		-40 °C to +85 °C	Refer to Application guide. "Frequency range"
Frequency stability	$\Delta f/f_0$	B: $\pm 50 \times 10^{-6}$, C: $\pm 100 \times 10^{-6}$ M: $\pm 100 \times 10^{-6}$			B, C: -20 °C to +70 °C M: -40 °C to +85 °C *3
Current consumption	I_{OP}	45 mA Max.		28 mA Max.	No load condition, Max. frequency range
Output disable current	I_{OE}	30 mA Max.		16 mA Max.	OE=GND(PT,PH,PC)
Standby current	I_{ST}	50 μ A Max.			\overline{ST} =GND(ST,SH,SC)
Duty *1	tw/t	—	40 % to 60 %		CMOS load:50 % V_{DD} , Max. load condition
High output voltage	V_{OH}	$V_{DD}-0.4$ V Min.			TTL load: 1.4V, Max. load condition
Low output voltage	V_{OL}	0.4 V Max.			$I_{OH}=-16$ mA(PT / ST,PH / SH), -8 mA(PC / SC)
Output load condition (TTL) *1	N	5TTL Max.		—	$I_{OL}=16$ mA(PT / ST,PH / SH), 8 mA(PC / SC)
Output load condition (CMOS) *1	CL	15 pF Max.	15 pF Max. (CA:25 pF Max.)	15 pF Max.	$f_0 \leq 90$ MHz, Max. operating voltage
Output enable / disable input voltage	V_{IH}	2.0 V Min.		70 % V_{DD} Min.	\overline{ST} , OE terminal
	V_{IL}	0.8 V Max.		20 % V_{DD} Max.	\overline{ST} , OE terminal
Output rise and fall time *1	t_r / t_f	3 ns Max.			CMOS load: 20 % V_{DD} to 80 % V_{DD} level
		4 ns Max.		—	TTL load: 0.4 V to 2.4 V level
Oscillation start up time	t_{OSC}	10 ms Max.			Time at minimum operating voltage to be 0 s
Aging	fa	$\pm 5 \times 10^{-6}$ / year Max.			$T_a=+25$ °C, $V_{DD}=5.0$ V / 3.3 V (PC / SC) First year

*1 Operating temperature (-40 °C to +85 °C), the available frequency, duty and output load conditions, please refer to Page 40.

*2 PLL-PLL connection & Jitter specification, please refer to Page 41.

*3 PT / ST and PH / SH for "M" stability will be available up to 55 MHz. (JF:40 MHz)
 Checking possible by the Frequency Checking Program.

<http://www.epsondevice.com/domcfg.nsf>

External dimensions

(Unit:mm)

Recommended soldering pattern (Unit:mm)

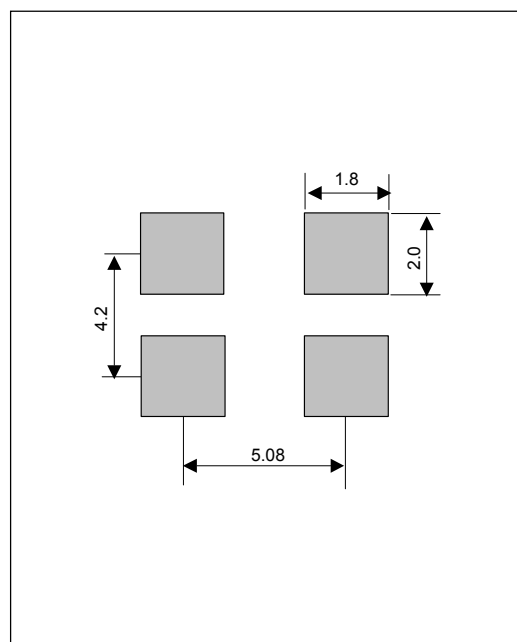
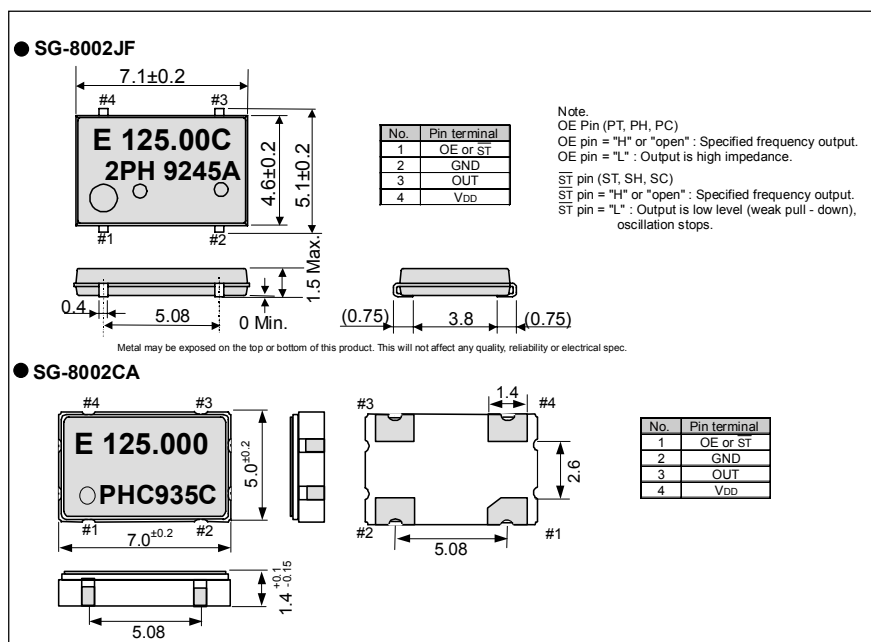

PROGRAMMABLE HIGH-FREQUENCY CRYSTAL OSCILLATOR

SG - 8002JC / JA series

Product number (please contact us)

SG-8002JC : Q3307JCx1xxxx00
 SG-8002JA : Q3306JAx1xxxx00

- Frequency range : 1 MHz to 125 MHz
- Operating voltage : 3.3 V or 5.0 V
- Function : Output enable(OE) or Standby(\overline{ST})
- Thickness : 2.7 mm Max.(SG-8002JC)
4.7 mm Max.(SG-8002JA)

Package and pin compatible with SG-636 (SG-8002JC)
 Package and pin compatible with SG-615 (SG-8002JA)
 •Lead(Pb)-free : Complies with EU RoHS directive
 •Short mass production lead time by PLL technology.
 •SG-Writer available to purchase.
 Please contact EPSON or local sales representative.

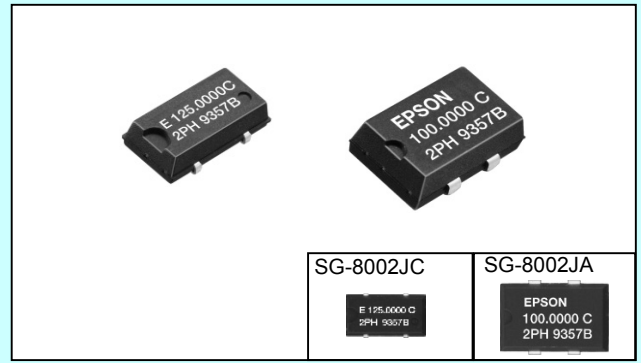

Specifications (characteristics)

Item	Symbol	Specifications *2			Remarks	
		PT / ST	PH / SH	PC / SC		
Output frequency range	fo	1 MHz to 125 MHz			VDD=4.5 V to 5.5 V	
		—			VDD=3.0 V to 3.6 V	
		—			VDD=2.7 V to 3.6 V	
Operating voltage	VDD	4.5 V to 5.5 V			2.7 V to 3.6 V	
Temperature range	Storage temperature	-55 °C to +125 °C (JC:-55 °C to +100 °C)			Stored as bare product after unpacking	
	Operating temperature	-20 °C to +70 °C (-40 °C to +85 °C)		-40 °C to +85 °C	Refer to Application guide. "Frequency range" SG-8002JC:-20 °C to +70 °C Only	
Frequency stability	Δf/fo	B: ±50 × 10 ⁻⁶ , C: ±100 × 10 ⁻⁶ M: ±100 × 10 ⁻⁶			B,C:-20 °C to +70 °C M:-40 °C to +85 °C *3	
Current consumption	IOP	45 mA Max.		28 mA Max.	No load condition, Max. frequency	
Output disable current	IOE	30 mA Max.		16 mA Max.	OE=GND(PT,PH,PC)	
Standby current	IST	50 μA Max.			\overline{ST} =GND(ST,SH,SC)	
Duty *1	tw/t	—		40 % to 60 %	CMOS load:50 % VDD, Max. load condition	
		40 % to 60 %		—	TTL load: 1.4V, Max. load condition	
High output voltage	VOH	VDD-0.4 V Min.			I _{OH} =-16 mA(PT,ST,PH,SH), -8 mA(PC,SC)	
Low output voltage	VOL	0.4 V Max.			I _{OL} =16 mA(PT,ST,PH,SH), 8 mA(PC,SC)	
Output load condition (TTL) *1	N	5TTL Max.		—	fo ≤ 90 MHz and Max. operating voltage	
Output load condition (CMOS) *1	CL	15pF Max.			Max. frequency and Max. operating voltage	
Output enable / disable input voltage	V _{IH}	2.0 V Min.		70 % VDD Min.	\overline{ST} , OE terminal	
	V _{IL}	0.8 V Max.		20 % VDD Max.	\overline{ST} , OE terminal	
Output rise and fall time *1	t _r / t _f	—			3 ns Max.	CMOS load: 20 % VDD to 80 % VDD level
		4 ns Max.		—	—	TTL load: 0.4 V to 2.4 V level
Oscillation start up time	t _{osc}	10 ms Max.			Time at minimum operating voltage to be 0 s	
Aging	fa	±5 × 10 ⁻⁶ / year Max.			T _a =+25 °C,VDD=5.0 V/ 3.3 V (PC,SC) First year	

*1 Operating temperature (-40 °C to +85 °C), the available frequency, duty and output load conditions, please refer to Page 40.

*2 PLL-PLL connection & Jitter specification, please refer to Page 41.

*3 PT / ST and PH / SH for "M" stability will be available up to 55 MHz.(Except;SG-8002JC)

Checking possible by the Frequency Checking Program.

<http://www.epsondevice.com/domcfg.nsf>

External dimensions

(Unit:mm) ■ Recommended soldering pattern (Unit:mm)

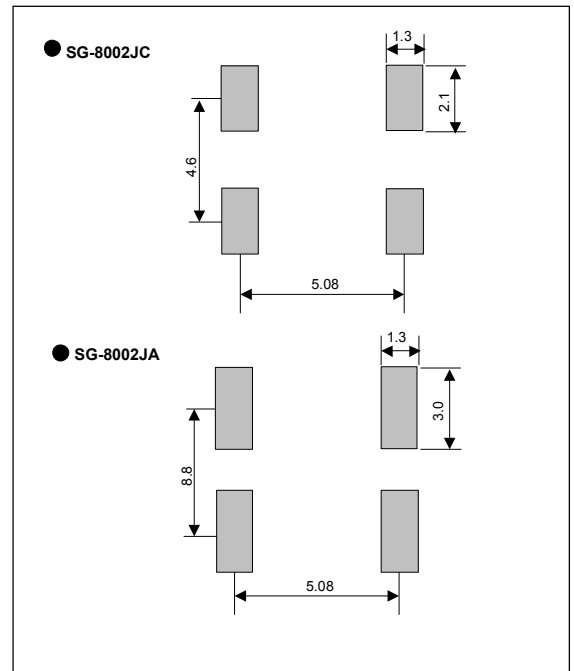
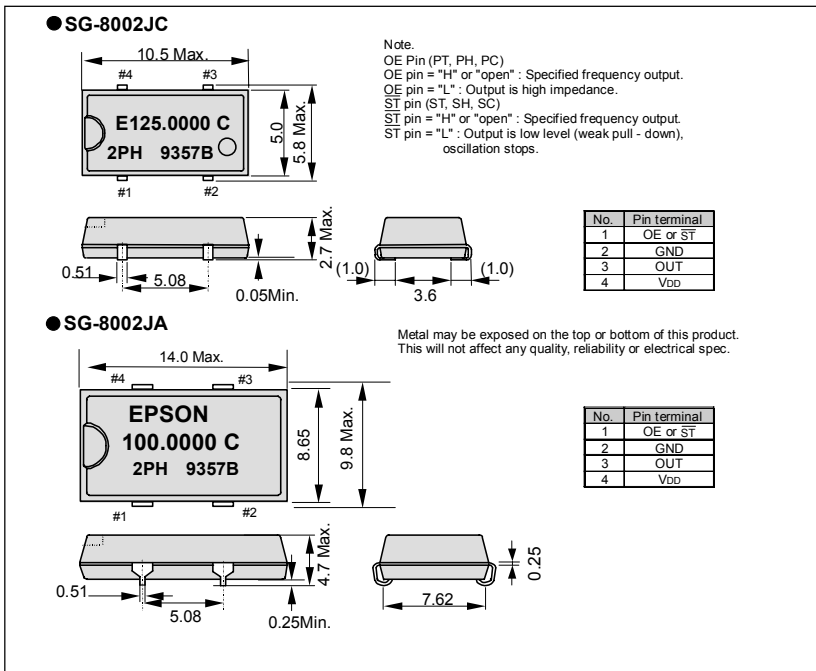

PROGRAMMABLE HIGH-FREQUENCY CRYSTAL OSCILLATOR

SG - 8002DC / DB series

Product number (please contact us)
SG-8002DC : Q3204DCx1xxxx00
SG-8002DB : Q3203DBx1xxxx00

- Frequency range : 1 MHz to 125 MHz
- Operating voltage : 3.3 V or 5.0 V
- Function : Output enable(OE) or Standby(\overline{ST})
Pin compatible with full size and half size.
- Lead(Pb)-free : Complies with EU RoHS directive
- Short mass production lead time by PLL technology.
- SG-Writer available to purchase.
Please contact EPSON or local sales representative.

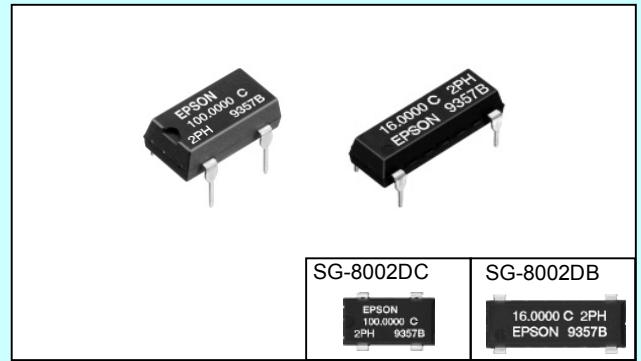

Actual size

Specifications (characteristics)

Item	Symbol	Specifications *2			Remarks
		PT / ST	PH / SH	PC / SC	
Output frequency range	f_0	1 MHz to 125 MHz	—	—	$V_{DD}=4.5\text{ V to }5.5\text{ V}$
Operating voltage	V_{DD}	—	—	1 MHz to 125 MHz	$V_{DD}=3.0\text{ V to }3.6\text{ V}$
		—	—	1 MHz to 66.7 MHz	$V_{DD}=2.7\text{ V to }3.6\text{ V}$
Temperature range	Storage temperature	-55 °C to +125 °C			Stored as bare product after unpacking
	Operating temperature	-20 °C to +70 °C (-40 °C to +85 °C)		-40 °C to +85 °C	Refer to Application guide. "Frequency range"
Frequency stability	$\Delta f/f_0$	B: $\pm 50 \times 10^{-6}$, C: $\pm 100 \times 10^{-6}$ M: $\pm 100 \times 10^{-6}$			B, C: -20 °C to +70 °C M: -40 °C to +85 °C *3
Current consumption	I_{OP}	45 mA Max.		28 mA Max.	No load condition, Max. frequency
Output disable current	I_{OE}	30 mA Max.		16 mA Max.	OE=GND(PT,PH,PC)
Standby current	I_{ST}	50 μ A Max.			ST =GND(ST,SH,SC)
Duty *1	tw/t	—	40 % to 60 %		CMOS load:50% V_{DD} , Max. load condition
		40 % to 60 %	—		TTL load: 1.4V, Max. load condition
High output voltage	V_{OH}	$V_{DD}-0.4\text{ V Min.}$			$I_{OH}=-16\text{ mA(PT,ST,PH,SH)}$, -8 mA(PC,SC)
Low output voltage	V_{OL}	0.4 V Max.			$I_{OL}=16\text{ mA(PT,ST,PH,SH)}$, 8 mA(PC,SC)
Output load condition (TTL) *1	N	5TTL Max.		—	Max. frequency and
Output load condition (CMOS) *1	C_L	15pF Max.		25pF Max.	15pF Max.
Output enable / disable input voltage	V_{IH}	2.0 V Min.		70 % V_{DD} Min.	ST , OE terminal
	V_{IL}	0.8 V Max.		20 % V_{DD} Max.	\overline{ST} , OE terminal
Output rise and fall time *1	t_R / t_F	3 ns Max.			CMOS load: 20 % V_{DD} to 80 % V_{DD} level
	—	4 ns Max.		—	TTL load: 0.4 V to 2.4 V level
Oscillation start up time	t_{osc}	10 ms Max.			Time at minimum operating voltage to be 0 s
Aging	f_a	$\pm 5 \times 10^{-6}$ / year Max.			$T_a=+25\text{ }^\circ\text{C}$, $V_{DD}=5.0\text{ V/ }3.3\text{ V (PC/SC)}$ First year

*1 Operating temperature (-40 °C to +85 °C), the available frequency, duty and output load conditions, please refer to Page 40.

*2 PLL-PLL connection & Jitter specification, please refer to Page 41.

*3 PT / ST and PH / SH for "M" stability will be available up to 55 MHz.

Checking possible by the Frequency Checking Program.

<http://www.epsondevice.com/domcfg.nsf>

External dimensions

(Unit:mm)

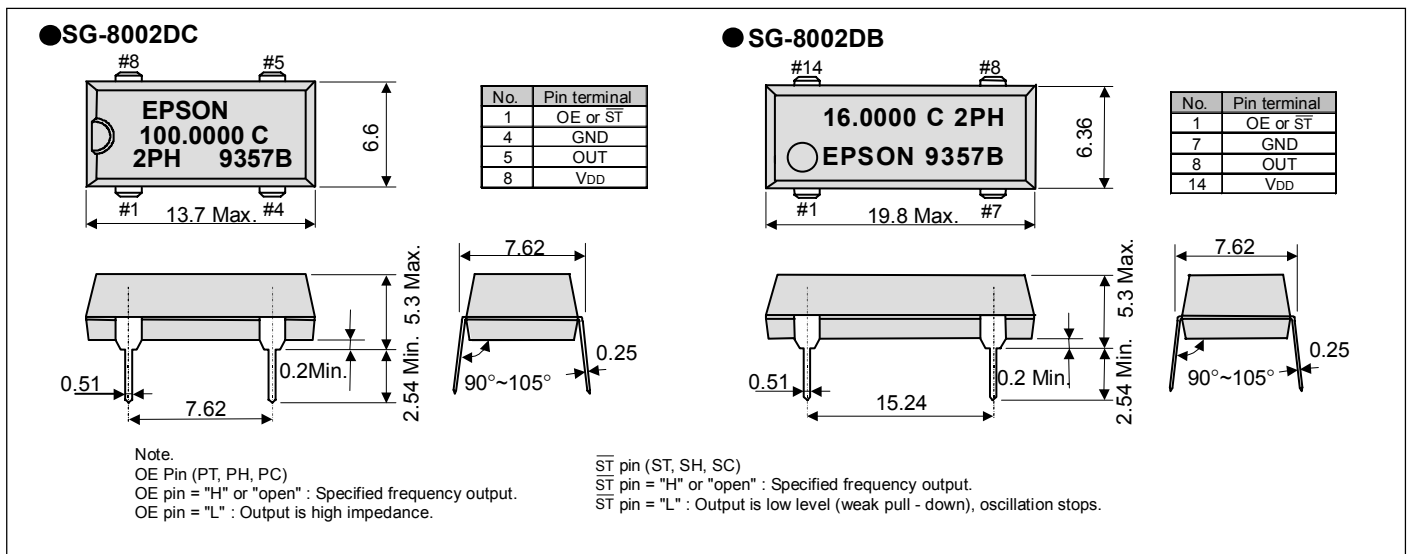

SG-8002 Series Specifications

Page	Model	Item	Current Consumption	Operating Voltage	Output load condition	Output rise time Output fall time	Duty	Function				
36	SG-8002LA (SON 4-pin)	PH	35 mA Max.	4.5 V to 5.5 V	15 pF	3.0 ns Max. (20 % V _{DD} to 80 % V _{DD} , CL=Max.)	40 % to 60 % (50 % V _{DD} , CL=15 pF, f _{osc} 80 MHz/-40 °C to +85 °C)	OE				
		SH						ST				
	SG-8002LB (SOJ 4-pin)	PC	28 mA Max.	3.0 V to 3.6 V (2.7 V to 3.6 V)	15 pF	3.0 ns Max. (20 % V _{DD} to 80 % V _{DD} , CL=Max.)	45 % to 55 % (50 % V _{DD} , CL=15 pF, V _{DD} =3.0 V to 3.6 V, f _{osc} 40 MHz) 40 % to 60 % (50 % V _{DD} , CL=15 pF, V _{DD} =3.0 V to 3.6 V, f _{osc} 125 MHz) ↑ (50 % V _{DD} , CL=15 pF, V _{DD} =2.7 V to 3.6 V, f _{osc} 66.7 MHz)	OE				
		SC						ST				
37 38 39	SG-8002CA (DCC)	PT	45 mA Max.	4.5 V to 5.5 V	5 TTL+15 pF (f _{osc} 125MHz/-20 °C to +70 °C)	2.0 ns Max. (0.8 V to 2.0 V, CL=Max.)	45 % to 55 % (1.4 V, CL=5 TTL+15 pF, f _{osc} 66.7 MHz/-20 °C to +70 °C) ↑ (1.4 V, CL=5 TTL+15 pF, f _{osc} 40.0 MHz/-40 °C to +85 °C)	OE				
		ST			25 pF (f _{osc} 66.7 MHz/-20 °C to +70 °C)			40 % to 60 % (1.4 V, CL=5 TTL+15 pF, f _{osc} 125 MHz/-20 °C to +70 °C) ↑ (1.4 V, CL=5 TTL+15 pF, f _{osc} 55.0 MHz/-40 °C to +85 °C)	ST			
	SG-8002JA (SOJ 4-pin)	PH	28 mA Max.	3.0 V to 3.6 V (2.7 V to 3.6 V)	25 pF (f _{osc} 125 MHz/-20 °C to +70 °C)	3.0 ns Max. (20 % V _{DD} to 80 % V _{DD} , CL=25)	45 % to 55 % (50 % V _{DD} , CL=25 pF, f _{osc} 66.7 MHz/-20 °C to +70 °C) ↑ (50 % V _{DD} , CL=25 pF, f _{osc} 40.0 MHz/-40 °C to +85 °C)	OE				
		SH			50 pF (f _{osc} 66.7 MHz/-20 °C to +70 °C)			40 % to 60 % (50 % V _{DD} , CL=25 pF, f _{osc} 125 MHz/-20 °C to +70 °C) ↑ (50 % V _{DD} , CL=50 pF, f _{osc} 66.7 MHz/-20 °C to +70 °C)	ST			
	SG-8002DB (DIP 14-pin)	SH	28 mA Max.	3.0 V to 3.6 V (2.7 V to 3.6 V)	15 pF (f _{osc} 55 MHz/-40 °C to +85 °C)	4.0 ns Max. (20 % V _{DD} to 80 % V _{DD} , CL=Max.)	45 % to 55 % (50 % V _{DD} , CL=50 pF, f _{osc} 66.7 MHz/-20 °C to +70 °C) ↑ (50 % V _{DD} , CL=15 pF, f _{osc} 55.0 MHz/-40 °C to +85 °C)	OE				
		PC			25 pF (f _{osc} 40 MHz/-40 °C to +85 °C)			40 % to 60 % (50 % V _{DD} , CL=15 pF, V _{DD} =3.0 V to 3.6 V, f _{osc} 125 MHz) ↑ (50 % V _{DD} , CL=15 pF, V _{DD} =2.7 V to 3.6 V, f _{osc} 66.7 MHz)	ST			
	38	SG-8002JC (SOJ 4-pin)	PT	45 mA Max.	4.5 V to 5.5 V	5TTL + 15 pF (f _{osc} 90 MHz/-20 to +70 °C)	2.0 ns Max. (0.8 V to 2.0 V, CL=Max.)	45 % to 55 % (1.4 V, CL=5 TTL+15 pF, f _{osc} 66.7 MHz/-20 °C to +70 °C) 40 % to 60 % (1.4 V, CL=5 TTL+15 pF, f _{osc} 90.0 MHz/-20 °C to +70 °C) ↑ (1.4 V, CL=25 pF, f _{osc} 66.7 MHz/-20 °C to +70 °C) ↑ (1.4 V, CL=15 pF, f _{osc} 125 MHz/-20 °C to +70 °C)	OE			
			ST			15 pF (f _{osc} 125 MHz/-20 °C to +70 °C)			4.0 ns Max. (0.4 V to 2.4 V, CL=Max.)	ST		
PH			25 pF (f _{osc} 66.7 MHz/-20 °C to +70 °C)			3.0 ns Max. (20 % V _{DD} to 80 % V _{DD} , CL=25)			OE			
SH			50 pF (f _{osc} 90 MHz/-20 °C to +70 °C)			4.0 ns Max. (20 % V _{DD} to 80 % V _{DD} , CL=Max.)			ST			
SG-8002DC (DIP 8-pin)		PC	28 mA Max.	3.0 V to 3.6 V (2.7 V to 3.6 V)	15 pF (f _{osc} 66.7 MHz/2.7 to 3.6 V)	3.0 ns Max. (20 % V _{DD} to 80 % V _{DD} , CL=15)	45 % to 55 % (50 % V _{DD} , CL=30 pF, V _{DD} =3.0 V to 3.6 V, f _{osc} 40 MHz) 40 % to 60 % (50 % V _{DD} , CL=15 pF, V _{DD} =3.0 V to 3.6 V, f _{osc} 125 MHz) ↑ (50 % V _{DD} , CL=15 pF, V _{DD} =2.7 V to 3.6 V, f _{osc} 66.7 MHz)	OE				
		SC			30 pF (f _{osc} 40 MHz/3.0 to 3.6 V)			4.0 ns Max. (20 % V _{DD} to 80 % V _{DD} , CL=Max.)	ST			
37	SG-8002JF (SOJ 4-pin)	PT	45 mA Max.	4.5 V to 5.5 V	15 pF (f _{osc} 125 MHz/-20 °C to +70 °C)	2.0 ns Max. (0.8 V to 2.0 V, CL=25)	45 % to 55 % (1.4 V, CL=5 TTL+15 pF, f _{osc} 66.7 MHz/-20 °C to +70 °C) 40 % to 60 % (1.4 V, CL=5 TTL+15 pF, f _{osc} 90 MHz/-20 °C to +70 °C) ↑ (1.4 V, CL=25 pF, f _{osc} 66.7 MHz/-20 °C to +70 °C) ↑ (1.4 V, CL=15 pF, f _{osc} 125 MHz/-20 °C to +70 °C) ↑ (1.4 V, CL=15 pF, f _{osc} 40 MHz/-40 °C to +85 °C)	OE				
		ST			25 pF (f _{osc} 66.7 MHz/-20 °C to +70 °C)			4.0 ns Max. (0.4 V to 2.4 V, CL=Max.)	ST			
		PH			5TTL + 15 pF (f _{osc} 90 MHz/-20 °C to +70 °C)			3.0 ns Max. (20 % V _{DD} to 80 % V _{DD} , CL=25)	OE			
		SH			15 pF (f _{osc} 125 MHz/-20 °C to +70 °C)			4.0 ns Max. (20 % V _{DD} to 80 % V _{DD} , CL=Max.)	ST			
	SG-8002CE (DCC)	PC	28 mA Max.	3.0 V to 3.6 V (2.7 V to 3.6 V)	15 pF (f _{osc} 66.7 MHz/2.7 to 3.6 V)	3.0 ns Max. (20 % V _{DD} to 80 % V _{DD} , CL=15)	45 % to 55 % (50 % V _{DD} , CL=30 pF, V _{DD} =3.0 V to 3.6 V, f _{osc} 40 MHz) 40 % to 60 % (50 % V _{DD} , CL=15 pF, V _{DD} =3.0 V to 3.6 V, f _{osc} 125 MHz) ↑ (50 % V _{DD} , CL=15 pF, V _{DD} =2.7 V to 3.6 V, f _{osc} 66.7 MHz)	OE				
		SC			15 pF (f _{osc} 125 MHz/3.0 to 3.6 V)			4.0 ns Max. (20 % V _{DD} to 80 % V _{DD} , CL=Max.)	ST			
		PT			40 mA Max.			4.5 V to 5.5 V	5 TTL+15 pF (f _{osc} 125 MHz/-20 °C to +70 °C)	2.0 ns Max. (0.8 V to 2.0 V, CL=Max.)	45 % to 55 % (1.4 V, CL=5 TTL+15 pF, f _{osc} 66.7 MHz/-20 °C to +70 °C) ↑ (1.4 V, CL=5 TTL+15 pF, f _{osc} 27.0 MHz/-40 °C to +85 °C)	OE
		ST							5 TTL+15 pF (f _{osc} 27 MHz/-40 °C to +85 °C)			4.0 ns Max. (0.4 V to 2.4 V, CL=Max.)
SG-8002CE (DCC)	PH	28 mA Max.	3.0 V to 3.6 V (2.7 V to 3.6 V)	15 pF (f _{osc} 125 MHz/-20 °C to +70 °C)	3.0 ns Max. (20 % V _{DD} to 80 % V _{DD} , CL=Max.)	45 % to 55 % (50 % V _{DD} , CL=25 pF, f _{osc} 66.7 MHz/-20 °C to +70 °C) ↑ (50 % V _{DD} , CL=25 pF, f _{osc} 27.0 MHz/-40 °C to +85 °C)	OE					
	SH			25 pF (f _{osc} 100 MHz/-20 °C to +70 °C)			40 % to 60 % (50 % V _{DD} , CL=15 pF, f _{osc} 125 MHz/-20 °C to +70 °C)	ST				
SG-8002CE (DCC)	PC	28 mA Max.	3.0 V to 3.6 V (2.7 V to 3.6 V)	15 pF (f _{osc} 66.7 MHz/2.7 to 3.6 V)	3.0 ns Max. (20 % V _{DD} to 80 % V _{DD} , CL=Max.)	45 % to 55 % (50 % V _{DD} , CL=15 pF, V _{DD} =3.0 V to 3.6 V, f _{osc} 40 MHz) 40 % to 60 % (50 % V _{DD} , CL=15 pF, V _{DD} =3.0 V to 3.6 V, f _{osc} 125 MHz) ↑ (50 % V _{DD} , CL=15 pF, V _{DD} =2.7 V to 3.6 V, f _{osc} 66.7 MHz)	OE					
	SC			15 pF (f _{osc} 125 MHz/3.0 to 3.6 V)			ST					

■SG-8002 series and HG-8002 series

■PLL-PLL connection

Because we use a PLL technology, there are a few cases that the jitter value will increase when SG-8002 is connected to another PLL-oscillator.

In our experience, we are unable to recommend these products for the applications such as telecom carrier use or analog video clock use. Please be careful checking in advance for these application (Jitter specification is Max.250 ps/CL=15 pF)

■Remarks on noise management for power supply line

We do not recommend inserting filters or other devices in the power supply line as the counter measure of EMI noise reduction. This device insertion might cause high-frequency impedance high in the power supply line and it affects oscillator stable drive. When this measure is required, please evaluate circuitry and device behavior in the circuit and verify that it will not affect oscillation. Start up time (0 % VDD to 90 % VDD) of power source should be more than 150 μs.

■Jitter Specifications

Model	Operating Voltage	Jitter Item	Specifications	Remarks
PT / PH ST / SH	5 V ±0.5 V	Cycle to cycle	150 ps Max.	33 MHz ≤ f ₀ ≤ 125 MHz, C _L =15 pF
			200 ps Max.	1.0 MHz ≤ f ₀ < 33 MHz, C _L =15 pF
		Peak to peak	200 ps Max.	33 MHz ≤ f ₀ ≤ 125 MHz, C _L =15 pF
			250 ps Max.	1.0 MHz ≤ f ₀ < 33 MHz, C _L =15 pF
SC / PC	3.3 V ±0.3 V	Cycle to cycle	200 ps Max.	1.0 MHz ≤ f ₀ ≤ 125 MHz, C _L =15 pF
		Peak to peak	250 ps Max.	1.0 MHz ≤ f ₀ ≤ 125 MHz, C _L =15 pF

■SG-8002 series Characteristics chart

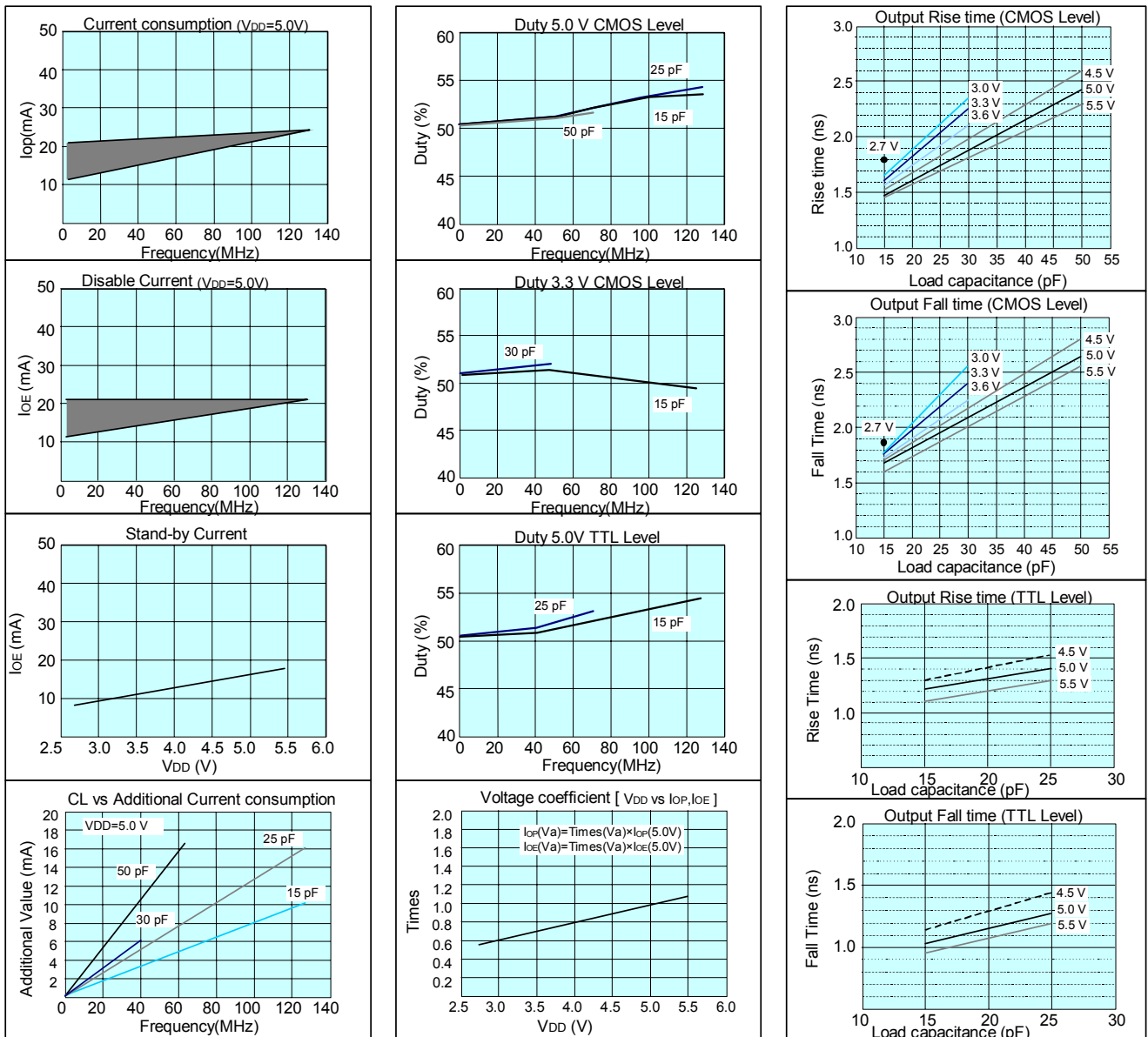

FOR SG-8002 SERIES PROGRAMMING TOOL

SG-WRITER**Product Number****Q91PR20W1101000**

- Easy frequency program for Epson SG-8002 series oscillator (Blank oscillator).
- Free power supply for USB accommodate.
- Flexible PC accommodate.
Windows98SE, 2000, Me, XP (Except Windows 95, NT)
- Small body and easy carry.

**■ Main Body Specifications**

Name	SG-Writer for EPSON SG-8002 Series
Product Number	Q91PR20W1101000
Operating Temperature	+10 °C to +40 °C Writing (+25 °C ±5 °C)
Electric Power Supply	Via USB
Standard Interface	USB Type B
External Dimensions (mm)	160 × 110 × 36 (textool top)
Weight	700 g
Accessories	SG-Writer CD-ROM (Software and Instruction manual : Japanese, English) Documents : Japanese, English
Software,Driver	SG-Writer *1 EPSON USB Driver
Option	SMD socket (JA, JC, CA, JF, CE, LA, LB type)

*1 SG-Writer software is available only from Epson website after user registration.

<http://www.epsondevice.com/qd/SG8002CS>

■ Recommend PC Specifications (Need connect PC and SG-Writer when you Writing.)

Accommodate OS	Windows XP, Windows Me, Windows 2000, Windows 98SE(Except Windows 95, NT)
Recommend CPU	Pentium Processor 200 MHz equivalent and higher (Recommend Over 300 MHz)
Recommend memory Capacity	Recommend Over 64 MB
Recommend HDD Capacity	Need Over 40 MB
Other	CD-ROM drive,USB cable(Type A ↔ Type B) Need SMD *2 socket when you write SG-8002 SMD products. (Sold individually)

*2 Conventional SMD socket can be used with new SG-Writer.

HIGH-FREQUENCY CRYSTAL OSCILLATOR WITH SPREAD SPECTRUM

SG-9001LB / CA / JC

Product number (please contact us)

- SG-9001LB : Q3331x2x0xxxx00
- SG-9001CA : Q3331x0x0xxxx00
- SG-9001JC : Q3331x1x1xxxx00

- Frequency range : 10 MHz to 166 MHz
- Operating voltage : 3.3 V
- Function : Output enable(OE)
- Thickness : 1.15 mm Typ.(SG-9001LB)
1.40 mm Typ.(SG-9001CA)
- Lead(Pb)-free : Complies with EU RoHS directive
(Lead free completely:SG-9001LB / CA)
- Range of spreading percentage is selectable by program
(Center or Down spread, 6 Values)

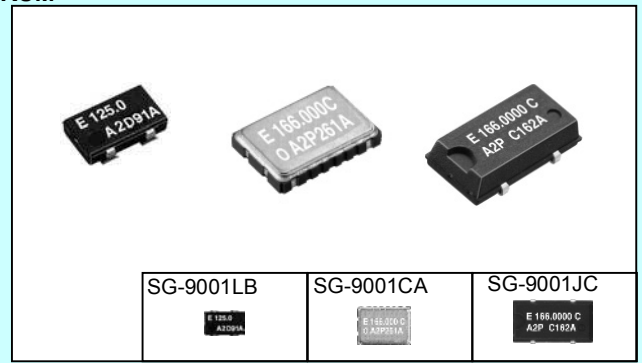

Actual size

Specifications (characteristics)

Item	Symbol	Specifications	Remarks
Output frequency range	f_0	10.000 MHz to 166.000 MHz	SG-9001JC,CA Please contact us for inquiries about the available frequency.
Operating voltage	V_{DD}	3.3 V \pm 0.3 V	SG-9001LB
Temperature range	Storage temperature	-55 °C to +100 °C	SG-9001JC
	Operating temperature	-40 °C to +125 °C	SG-9001LB,CA
Current consumption	I_{OP}	30 mA Max.	No load condition, $f_0 = 166$ MHz
Output disable current	I_{OE}	20 mA Max.	OE=GND, $f_0 = 166$ MHz
Duty	tw/t	45 % to 55 %	CMOS load: 50 % V_{DD} , $C_L=15$ pF
High output voltage	V_{OH}	$V_{DD}-0.4$ V Min.	$I_{OH}=-8$ mA
Low output voltage	V_{OL}	0.4 V Max.	$I_{OL}= 8$ mA
Output load condition	C_L	15 pF Max.	
Output enable / disable input voltage	V_{IH}	70 % V_{DD} Min.	OE terminal
	V_{IL}	30 % V_{DD} Max.	OE terminal
Output rise and fall time	t_R / t_F	2.7 ns Max.	20 % V_{DD} to 80 % V_{DD} level, $C_L=15$ pF.
Oscillation start up time	t_{OSC}	10 ms Max.	Time at minimum operating voltage to be 0 s
Aging	f_a	$\pm 5 \times 10^{-6}$ / year Max.	$T_a=+25$ °C, First year

Spread Spectrum Specifications

Center Spread	Code	C02P	C05P	C07P	C10P	C15P	C20P
	Percentage		± 0.25 %	± 0.5 %	± 0.75 %	± 1.0 %	± 1.5 %
Down Spread	Code	D05P	D10P	D15P	D20P	D30P	D40P
	Percentage		-0.5 %	-1.0 %	-1.5 %	-2.0 %	-3.0 %

External dimensions

(Unit:mm)

●SG-9001LB

Note.
OE pin
OE pin = "H" or "open" : Specified frequency output.
OE pin = "L" : Output disable output is weak pull-down. (130 k Ω Typ.)
SSON pin (SG-9001CA)
SSON pin = "H" : Spread spectrum disable.
SSON pin = "L" or "open" : Spread spectrum enable.

●SG-9001CA

●SG-9001JC

Metal may be exposed on the top or bottom of this product. This will not affect any quality, reliability or electrical spec.

Recommended soldering pattern

(Unit:mm)

●SG-9001LB

●SG-9001CA

●SG-9001JC

CMOS OUTPUT LOW-JITTER SAW OSCILLATOR

XG-1000CA / CB Series

Product number (Please contact us)

XG-1000CA : Q3851CA0xxxxx00

XG-1000CB : Q3851CB0xxxxx00

- Output frequency range : 50 MHz to 170 MHz
- Power source voltage : 1.8V / 2.5V / 3.3V
- Frequency stability : $\pm 50 \times 10^{-6}$, $\pm 100 \times 10^{-6}$
- Output : CMOS
- Function : Output enable(OE)
- Package size : CA:7.0×5.0×1.2 mm Typ.
CB:5.0×3.2×1.1mm Typ.
- Lead(Pb)-free : Complies with EU RoHS Directive.
(Lead free completely)
- Low-jitter oscillator with SAW.

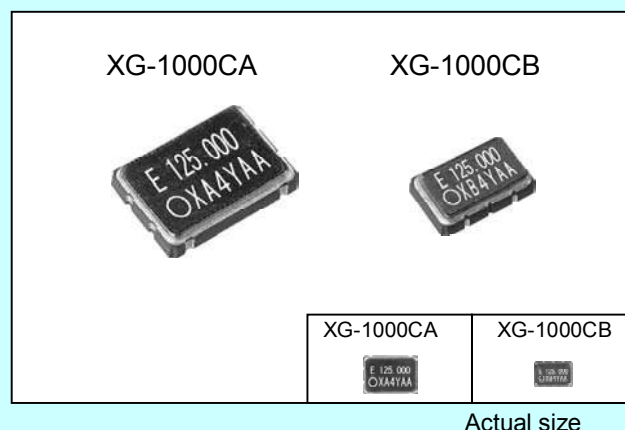

■ Specifications (characteristics)

Item	Symbol	Specifications			Remarks
		E	D	C	
Output frequency range *1	f_0	50.000 MHz to 170.000 MHz 75.000 MHz, 98.304 MHz, 100.000 MHz, 106.250 MHz, 125.000 MHz, 150.000 MHz			Standard frequency
Power source voltage	Max. supply voltage	-0.5 V to +4.0 V			
	Operating voltage	V _{DD}	1.8 V ± 0.1 V	2.5 V ± 0.125 V	
Temperature range	Storage temperature	-40 °C to +100 °C			Stored as bare product after unpacking
	Operating temperature	T _{OPR}	-10 °C to +70 °C		
Frequency stability *2	$\Delta f/f_0$	B: $\pm 50 \times 10^{-6}$ C: $\pm 100 \times 10^{-6}$			-10 °C to +70 °C
Current consumption	I _{DD}	20 mA Max.	25 mA Max.	35 mA Max.	No load condition, OE=V _{DD}
Output disable current	I _{OE}	15 mA Max.	20 mA Max.	30 mA Max.	OE=GND
Duty	tw/t	40 % to 60 %			CMOS load: 50 % V _{DD} level, Max. load condition
High output voltage	V _{OH}	V _{DD} -0.35 V Min			E: I _{OH} = -6 mA / C, D: I _{OH} = -8 mA
Low output voltage	V _{OL}	0.35 V Max.			E: I _{OL} = 6 mA / C, D: I _{OL} = 8 mA
Output load condition (C-MOS)	C _L	15 pF Max.			Max. frequency and Max. operating voltage range
Output enable/ Disable input voltage	V _{IH} V _{IL}	70 % V _{DD} Min. 30 % V _{DD} Max.			OE terminal OE terminal
Output rise and fall time	t _R / t _F	2 ns Max.			CMOS load : 20 % to 80 % V _{DD} level
Oscillation start up time	t _{OSC}	10 ms Max.			Time at minimum operating voltage to be 0 s
Jitter *3	t _{RMS} t _{p-p}	3 ps Typ. 25 ps Typ.			σ (RMS of total distribution) Peak to Peak
Aging	fa	$\pm 5 \times 10^{-6}$			T _a =+25 °C, First year, V _{DD} =1.8V, 2.5V, 3.3V

*1 Please contact us for inquiries regarding non-standard frequencies.

*2 This includes initial frequency tolerance, temperature variation, supply voltage variation and frequency stability vs. load.

*3 Based on DTS-2075 Digital timing system made from WAVECREST with jitter analysis software VISI6.

■ External dimensions

(Unit:mm) ■ Recommended soldering pattern (Unit:mm)

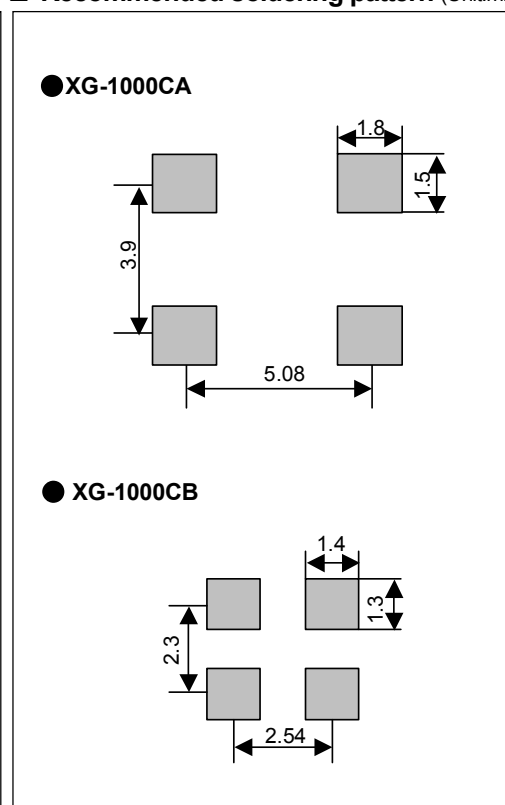
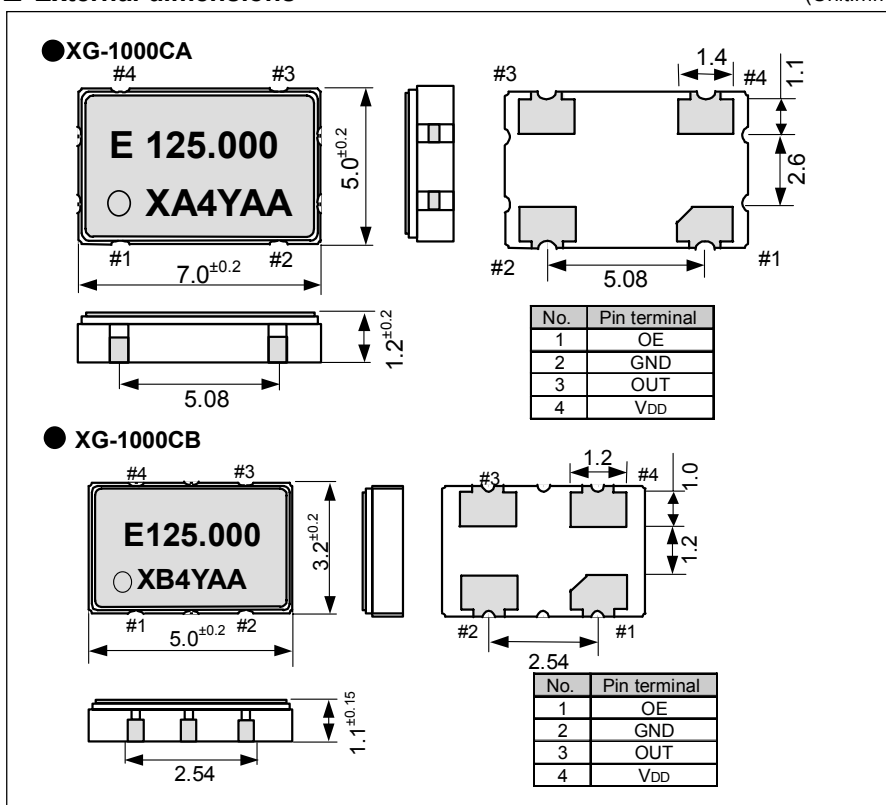

LOW-JITTER SAW OSCILLATOR

EG-2011/2021/2001CA series

Product number (please contact us)

- EG-2011CA : Q3808CA00xxxx00
- EG-2021CA : Q3807CA00xxxx00
- EG-2001CA : Q3801CA00xxxx00

- Frequency range : 62.5 MHz to 170 MHz
- Operating voltage : 1.8V/ EG-2011CA
2.5V/ EG-2021CA
3.3V/ EG-2001CA
- Output : CMOS
- Function : Output enable(OE)
- Thickness : 1.2 mm Typ.
- Lead(Pb)-free : Complies with EU RoHS directive
(Lead free completely)
- Very low jitter and low phase noise by SAW unit.

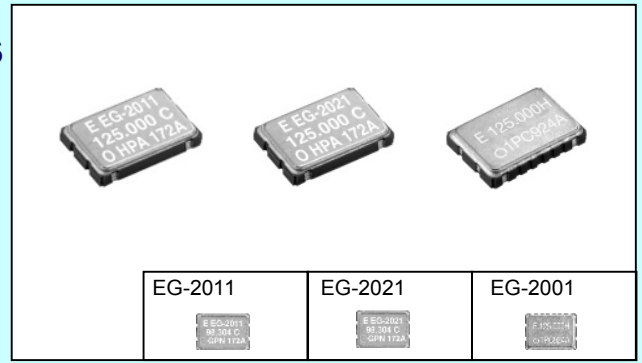

Actual Size

Specifications (characteristics)

Item	Symbol	Specifications			Remarks
		EG-2011CA	EG-2021CA	EG-2001CA	
Output frequency range	f ₀	62.500 MHz to 170.000 MHz		106.250 MHz to 170.000 MHz	
Power source voltage	Max. supply voltage	-0.5 V to +4.0 V			
	Operating voltage	V _{DD}	1.8 V± 0.1 V	2.5 V± 0.125 V	3.3 V± 0.3 V
Temperature range	Storage temperature	-40 °C to +100 °C			Stored as bare product after unpacking
	Operating temperature	T _{OPR}	P: 0 °C to +70 °C R: -5 °C to +85 °C		
Frequency stability	Δf/f ₀	G: ± 50 × 10 ⁻⁶ , H: ± 100 × 10 ⁻⁶		Z: ± 50 × 10 ⁻⁶ Y,H: ± 100 × 10 ⁻⁶	P: 0 °C to 70 °C, R: -5 °C to +85 °C *1
Current consumption	I _{DD}	20 mA Max.	25 mA Max.	50 mA Max.	No load condition, Max. frequency range
Output disable current	I _{OE}	600 μA Max.			OE=GND
Duty	tw/t	40 % to 60 % (45 % to 55 %)		45 % to 55 %	CMOS load: 50 % V _{DD} , C _L = Max. (EG-2011CA fo ≤ 125 MHz : 45 % to 55 %)
High output voltage	V _{OH}	V _{DD} -0.35 V Min.		V _{DD} -0.4 V Min.	I _{OH} = -8 mA(EG-2001,2021), -6 mA(EG-2011)
Low output voltage	V _{OL}	0.35 V Max.		0.4 V Max.	I _{OL} = 8 mA(EG-2001,2021), 6 mA(EG-2011)
Output load condition	C _L	15 pF Max.			Max. frequency and Max. operating voltage range
High input voltage	V _{IH}	70 % V _{DD} Min.			OE terminal
Low input voltage	V _{IL}	30 % V _{DD} Max.			OE terminal
Output rise and fall time	t _R / t _F	2 ns Max.			CMOS load: 20 % to 80 % V _{DD}
Oscillation start up time	t _{OSC}	10 ms Max.			Time at minimum operating voltage to be 0 s
Jitter *2	t _{DJ}	0.2 ps Typ.			Deterministic Jitter
	t _{RJ}	3 ps Typ.			Random Jitter
	t _{RMS}	3 ps Typ.			σ (RMS of total distribution)
	t _{P-P}	25 ps Typ.			Peak to Peak
	t _{acc}	4 ps Typ.			Accumulated Jitter(σ) n=2 to 50000 cycles
Phase Jitter	t _{PJ}	0.05 × 10 ⁻³ UI Typ.			offset frequency: 12 kHz to 20 MHz
		1 ps Max.			
Aging *3	f _a	± 10 × 10 ⁻⁶		± 5 × 10 ⁻⁶	T _a =+25 °C, First year, V _{DD} =1.8 V, 2.5 V, 3.3 V

*1 As per below table

*2 Based on DTS-2075 Digital timing system made from WAVECREST with jitter analysis software VISI6.

*3 Except: CHPA, CHRA, PCH

Model	EG-2011CA/EG-2021CA		
	Details of frequency stability		
Frequency stability	HP: ±100×10 ⁻⁶ (0°C to +70°C)	A *4	N *5
	HR: ±100×10 ⁻⁶ (-5°C to +85°C)	CHPA	CHPN
	GP: ±50×10 ⁻⁶ (0°C to +70°C)	CHRA	CHRN
	GR: ±50×10 ⁻⁶ (-5°C to +85°C)	CGPN	CGRN*7
		---	---

Model	EG-2001CA	
	Output mode	P: Duty 50 ± 5 %
Frequency stability	H: ±100×10 ⁻⁶ (0°C to +70°C) *4	PCH
	Y: ±100×10 ⁻⁶ (0°C to +70°C) *5	PCY
	Z: ±50×10 ⁻⁶ (0°C to +70°C) *6	PCZ

*4 This includes initial frequency tolerance, temperature variation, supply voltage variation, load variation, reflow drift, and aging(T_a=+25 °C, 10 years).

*5 This includes initial frequency tolerance, temperature variation, supply voltage variation, load variation, and reflow drift.(except aging)

*6 This includes initial frequency tolerance, and temperature variation.(except reflow drift, supply voltage variation, load variation and aging)

*7 Please contact us for inquiries.

External dimensions

(Unit:mm)

Recommended soldering pattern (Unit:mm)

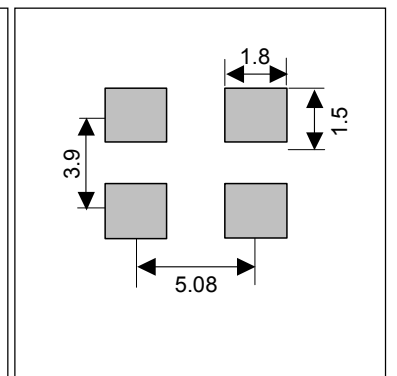
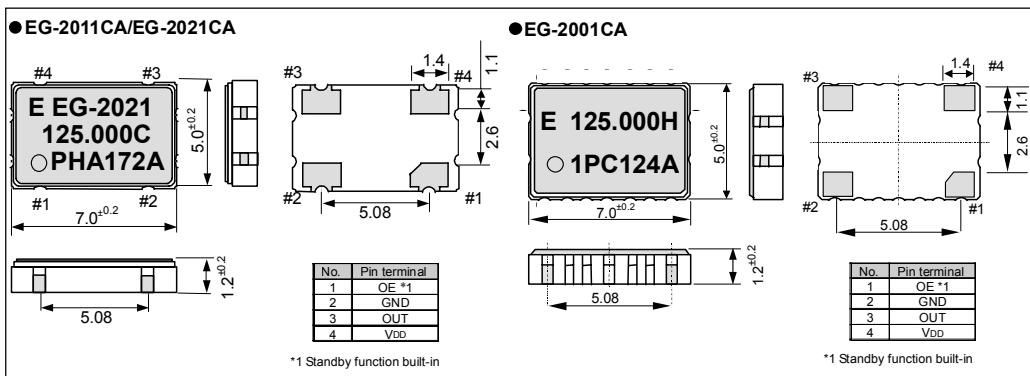

LOW JITTER SAW OSCILLATOR

EG - 2002CA

Product number (please contact us)
Q3802CA00xxxx00

- Frequency range : 62.5 MHz to 170 MHz
- Operating voltage : 3.3 V
- Output : LV-TTL
- Function : Output enable(OE)
- Thickness : 1.2 mm Typ.
- Lead(Pb)-free : Complies with EU RoHS directive
(Lead free completely)
- Very low jitter and low phase noise by SAW unit.

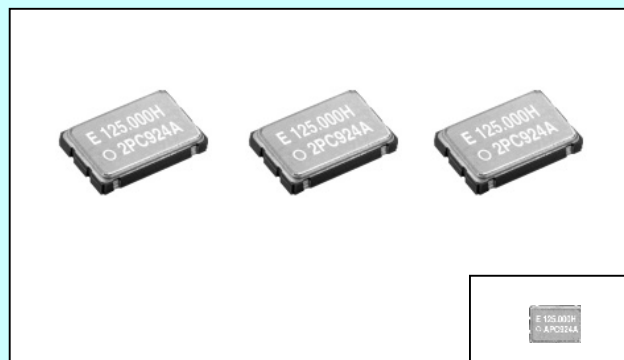

Actual size

■ Specifications (characteristics)

Item	Symbol	Specifications	Remarks
Output frequency range	f_0	62.500 MHz to 170.000 MHz	Please contact us for inquiries about the available frequency
Power source voltage	Max. supply voltage	V_{DD-GND}	-0.5 V to +7.0 V
	Operating voltage	V_{DD}	3.3 V \pm 0.3 V
Temperature range	Storage temperature	T_{STG}	-40 °C to +100 °C
	Operating temperature	T_{OPR}	0 °C to +70 °C
Frequency stability	$\Delta f/f_0$	$\pm 50 \times 10^{-6}$, $\pm 100 \times 10^{-6}$	0 °C to +70 °C *1
Current consumption	I_{DD}	60 mA Max.	OE= V_{DD} , No load condition
Output disable current	I_{OE}	25 mA Max.	OE=GND
Duty	tw/t	45 % to 55 %	1.4 V Level, $C_L \leq$ Max.
High output voltage	V_{OH}	2.4 V Min.	$I_{OH} = -8$ mA
Low output voltage	V_{OL}	0.4 V Max.	$I_{OL} = 8$ mA
Output load condition	C_L	25 pF Max.	$f_0 = 62.5$ MHz
		15 pF Max.	$f_0 > 62.5$ MHz
High input voltage	V_{IH}	70 % V_{DD} Min.	OE terminal
Low input voltage	V_{IL}	30 % V_{DD} Max.	OE terminal
Output rise and fall time	t_{R}/t_{F}	1.5 ns Max.	0.8 V \rightarrow 2.0 V, $C_L \leq$ Max.
Oscillation start up time	t_{OSC}	10 ms Max.	Time at minimum operating voltage to be 0 s
Jitter *2	t_{DJ}	0.2 ps Typ.	Deterministic Jitter
	t_{RJ}	3 ps Typ.	Random Jitter
	t_{RMS}	3 ps Typ.	σ (RMS of total distribution)
	t_{P-P}	25 ps Typ.	Peak to Peak
	t_{acc}	4 ps Typ.	Accumulated Jitter(σ) n=2 to 50000 cycles
Phase Jitter	t_{PJ}	0.05×10^{-3} UI Typ.	offset frequency: 12 kHz to 20 MHz
		1 ps Max.	
Aging *3	f_a	$\pm 5 \times 10^{-6}$	$T_a = +25$ °C, First year, $V_{DD} = 3.3$ V

*1 As per below table

*2 Based on DTS-2075 Digital timing system made from WAVECREST with jitter analysis software VISI6.

*3 Except : PCH,DCH

Frequency range (MHz)		P: 125 to 170	D: 62.5 to 124.999
Details of frequency stability	H: $\pm 100 \times 10^{-6}$ (0 °C to +70 °C)*4	PCH	DCH
	Y: $\pm 100 \times 10^{-6}$ (0 °C to +70 °C)*5	PCY	DCY
	Z: $\pm 50 \times 10^{-6}$ (0 °C to +70 °C)*6	PCZ	DCZ
	F: $\pm 50 \times 10^{-6}$ (0 °C to +70 °C)*5	PCF (125 MHz Only)	—

*4 This includes initial frequency tolerance, temperature variation, supply voltage variation, load variation, reflow drift, and 10 years aging ($T_a = +25$ °C, 10 years).

*5 This includes initial frequency tolerance, temperature variation, supply voltage variation, load variation, and reflow drift (except 10 years aging).

*6 This includes initial frequency tolerance and temperature variation (except supply voltage variation, load variation, reflow drift, and 10 years aging).

■ External dimensions

(Unit:mm)

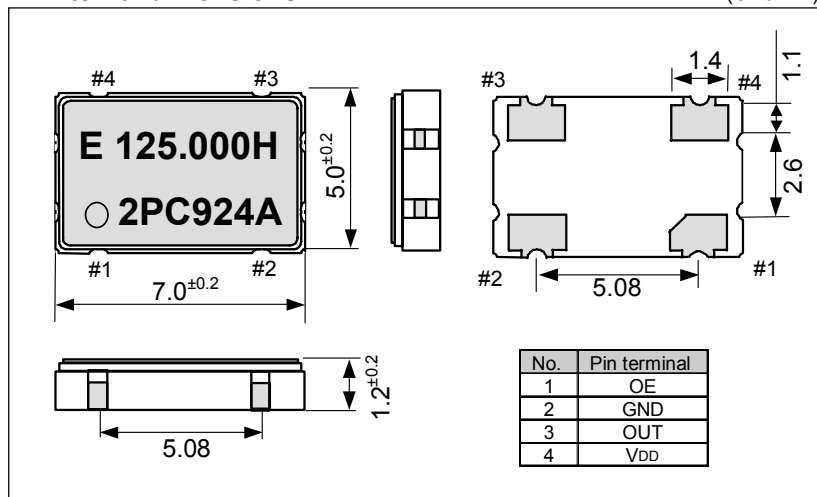

■ Recommended soldering pattern (Unit:mm)

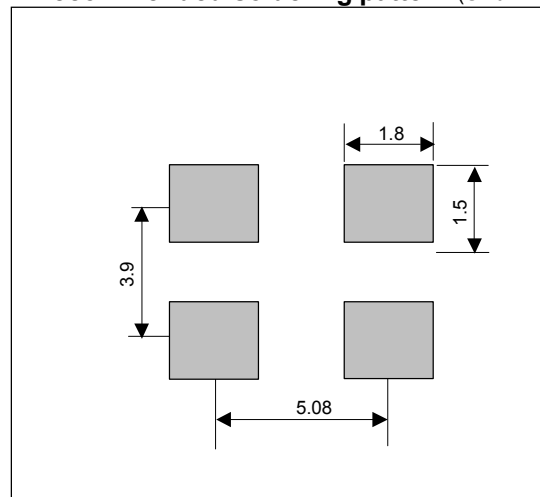

LOW JITTER SAW OSCILLATOR

EG-2121 / 2102CA series

Product number (please contact us)

EG-2121CA : Q3805CA00xxxx00 / Q3805CA10xxxx00
 EG-2102CA : Q3806CA00xxxx00 / Q3806CA10xxxx00

- Frequency range : 53.125 MHz to 700 MHz
- Operating voltage : 2.5 V (EG-2121CA)
3.3 V (EG-2102CA)
- Output : Differential LV-PECL or LVDS
- Function : Output enable(OE)
- Thickness : 1.2 mm Typ.
- Lead(Pb)-free : Complies with EU RoHS directive (Lead free completely)
- Very low jitter and low phase noise by SAW unit.

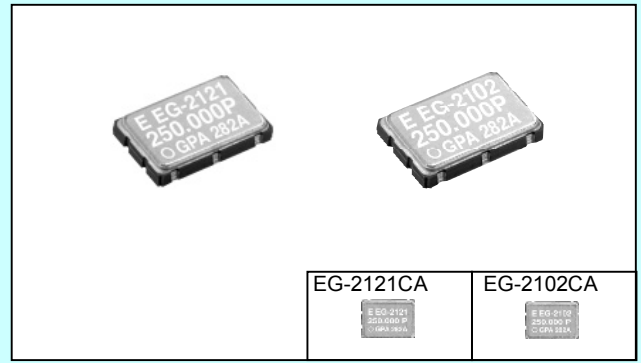

Actual size

Specifications (characteristics)

Item	Symbol	Specifications				Remarks
		EG-2121CA	EG-2102CA	EG-2121CA	EG-2102CA	
Output frequency range	f_0	Differential LV-PECL		LVDS		Please contact us for inquiries about the available frequency
		53.125 MHz to 500 MHz	100 MHz to 700 MHz	53.125 MHz to 700 MHz		
Power source voltage	Max. supply voltage	-0.5 V to +4.0 V				
	Operating voltage	Vcc	2.5 V ± 0.125 V	3.3 V ± 0.3 V	2.5 V ± 0.125 V 3.3 V ± 0.3 V	
Temperature range	Storage temperature	-40 °C to +100 °C				Stored as bare product after unpacking
	Operating temperature	P:0 °C to +70 °C ,R:-5 °C to +85 °C				
Frequency stability	$\Delta f/f_0$	G: $\pm 50 \times 10^{-6}$, H: $\pm 100 \times 10^{-6}$				P:0 °C to +70 °C,R:-5 °C to +85 °C *1
Current consumption	Icc	80 mA Max.	100 mA Max.	30 mA Max	45 mA Max.	OE=Vcc,RL=50 Ω or 100 Ω
Output disable current	Ioe	20 mA Max.	32 mA Max	20 mA Max	30 mA Max.	OE=GND
Duty	tw/t	P:45 % to 55 %		L:45 % to 55 %		fo=350 MHz (at outputs crossing point) *1
Output voltage	Voh	1.55 V Typ.	2.35 V Typ.	—		DC characteristics
		Vcc-1.025 to Vcc-0.88				
	Vol	0.8 V Typ.	1.6 V Typ.	—		
	Vod	—		350 mV Typ. 247 mV to 454 mV		Differential output, DC characteristics
	ΔV_{od}	—		50 mV		
	Vos	—		1.25 V Typ. 1.125 V to 1.375 V		
ΔV_{os}	—		150 mV			
Output load condition	Rl	50 Ω		100 Ω		LV-PECL: Terminated to Vcc -2.0 V LVDS: Connected between OUT to OUT
Output enable input voltage	Vih	70 % Vcc Min.				OE terminal
Output disable input voltage	Vil	30 % Vcc Max.				OE terminal
Output rise and fall time	tF / tR	400 ps Max.				LV-PECL: 80 % to 20 % (Voh-Vol) LVDS: 80 % to 20 % (Vod*2)
Oscillation start up time	tosc	10 ms Max.				Time at minimum operating voltage to be 0 s
Jitter *2	tDJ	0.2 ps Typ.				Deterministic Jitter
	tRJ	3 ps Typ.				Random Jitter
	tRMS	3 ps Typ.				σ (RMS of total distribution)
	tP-P	25 ps Typ.				Peak to Peak
	tacc	4 ps Typ.				Accumulated Jitter(σ) n=2 to 50000 cycles
	Phase Jitter	tPJ	0.05 $\times 10^{-3}$ UI Typ.			
Aging *3	fa	1 ps Max. $\pm 10 \times 10^{-6}$				Ta=+25 °C,First year,Vcc=2.5 V,3.3 V

*1 As per below table.

*2 Based on DTS-2075 Digital timing system made from WAVECREST with jitter analysis software VISI6.

*3 Except: **A

Output mode	P:Differential LV-PECL		D: Differential LV-PECL		L:LVDS		V:LVDS		
Frequency range	All range		fo \leq 175 MHz fo \leq 350 MHz		All range		fo \leq 175 MHz		
Duty	50 \pm 10 % (fo > 350 MHz) 50 \pm 5 % (fo \leq 350 MHz)		50 \pm 2 %		50 \pm 10 % (fo > 350 MHz) 50 \pm 5 % (fo \leq 350 MHz)		50 \pm 2 %		
Details of frequency stability									
Frequency stability	HP: $\pm 100 \times 10^{-6}$ (0°C to +70°C)	PHPA	PHPN	DHPA	DHPN	LHPA	LHPN	VHPA	VHPN
	HR: $\pm 100 \times 10^{-6}$ (-5°C to +85°C)	PHRA*6	PHRN*6	DHRA*6	DHRN*6	LHRA*6	LHRN*6	VHRA*6	VHRN*6
	GP: $\pm 50 \times 10^{-6}$ (0°C to +70°C)	PGPA*6	PGPN*6	DGPA*6	DGPN*6	LGPA*6	LGPN*6	VGPA*6	VGPN*6
	GR: $\pm 50 \times 10^{-6}$ (-5°C to +85°C)	—	PGRN*6	—	DGRN*6	—	LGRN*6	—	VGRN*6

*4 This includes initial frequency tolerance, temperature variation, supply voltage variation, reflow drift, and aging (Ta=+25 °C, 10 years).

*5 This includes initial frequency tolerance, temperature variation, supply voltage variation, and reflow drift(except aging).

*6 53.125 MHz \leq fo < 100 MHz : Unavailable.

External dimensions

(Unit:mm)

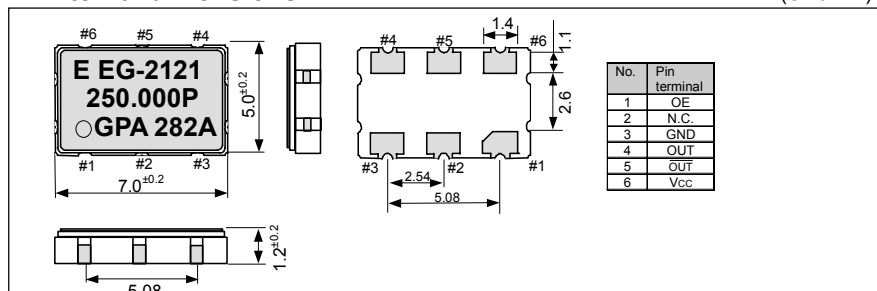

Recommended soldering pattern (Unit:mm)

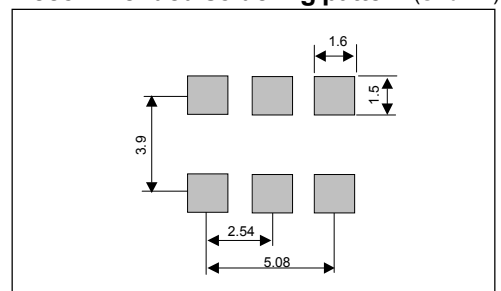

LOW JITTER SAW OSCILLATOR

EG-2101CA

Product number (please contact us)
Q3803CA00xxxx00

- Frequency range : 62.5 MHz to 400 MHz
- Operating voltage : 3.3 V
- Output : Differential LV-PECL
- Function : Output enable(OE)
- Thickness : 1.2 mm Typ.
- Lead(Pb)-free : Complies with EU RoHS directive
(Lead free completely)
- Very low jitter and low phase noise by SAW unit.

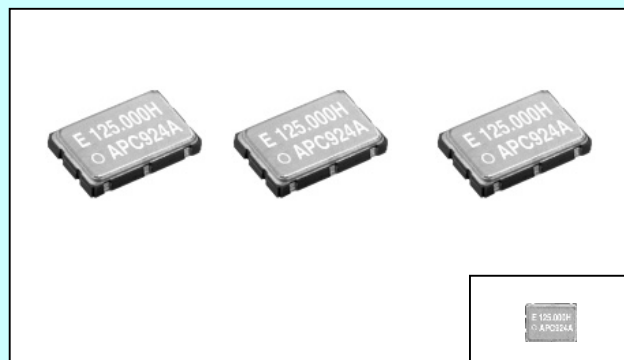

Actual Size

■ Specifications (characteristics)

Item	Symbol	Specifications	Remarks
Output frequency range	f_0	62.500 MHz to 400.000 MHz	Please contact us for inquiries about the available frequency
Power source voltage	Max. supply voltage	V_{CC-GND}	-0.5 V to +7.0 V
	Operating voltage	V_{CC}	3.3 V ± 0.15 V
Temperature range	Storage temperature	T_{STG}	-40 °C to +100 °C
	Operating temperature	T_{OPR}	0 °C to +70 °C
Frequency stability	$\Delta f/f_0$	$\pm 50 \times 10^{-6}$, $\pm 100 \times 10^{-6}$	0 °C to +70 °C *1
Current consumption	I_{CC}	60 mA Max.	OE= V_{CC} , $R_L=50 \Omega$
Output disable current	I_{OE}	25 mA Max.	OE=GND
Duty *3	tw/t	P:45 % to 55 %	at outputs crossing point
		D:47.5 % to 52.5 %	
High output voltage	V_{OH}	2.35 V Typ. $V_{CC}-1.025$ to $V_{CC}-0.88$	DC characteristics
Low output voltage	V_{OL}	1.60 V Typ. $V_{CC}-1.81$ to $V_{CC}-1.62$	
Output load condition	R_L	50 Ω	Terminated to $V_{CC} -2.0$ V
High input voltage	V_{IH}	70 % V_{CC} Min.	OE terminal
Low input voltage	V_{IL}	30 % V_{CC} Max.	OE terminal
Output rise and fall time	t_R / t_F	600 ps Max.	20 % to 80 % ($V_{OH}-V_{OL}$)
Oscillation start up time	t_{OSC}	10 ms Max.	Time at minimum operating voltage to be 0 s
Jitter *2	t_{DJ}	0.2 ps Typ.	Deterministic Jitter
	t_{RJ}	3 ps Typ.	Random Jitter
	t_{RMS}	3 ps Typ.	σ (RMS of total distribution)
	t_{P-P}	25 ps Typ.	Peak to Peak
	t_{acc}	4 ps Typ.	Accumulated Jitter(σ) n=2 to 50000 cycles
Phase Jitter	t_{PJ}	0.05 $\times 10^{-3}$ UI Typ.	offset frequency: 12 kHz to 20 MHz
		1 ps Max.	
Aging *3	f_a	$\pm 5 \times 10^{-6}$	$T_a=+25$ °C, First year, $V_{CC}=3.3$ V

*1 As per below table

*2 Based on DTS-2075 Digital timing system made from WAVECREST with jitter analysis software VISI6.

*3 Except : PCH,DCH

Output mode (Duty)		P:Duty 50 ± 5 %		D:Duty 50 ± 2.5 %	
Frequency range (MHz)		125 to 318.75	318.751 to 400	62.5 to 159.375	159.376 to 200
Details of frequency stability	H: $\pm 100 \times 10^{-6}$ (0 °C to +70 °C)*4	PCH	—	DCH	—
	Y: $\pm 100 \times 10^{-6}$ (0 °C to +70 °C)*5	PCY	PCY	DCY	DCY
	Z: $\pm 50 \times 10^{-6}$ (0 °C to +70 °C)*6	PCZ	—	DCZ	—

*4 This includes initial frequency tolerance, temperature variation, supply voltage variation, reflow drift, and aging ($T_a=+25$ °C, 10 years).

*5 This includes initial frequency tolerance, temperature variation, supply voltage variation, and reflow drift(except aging).

*6 This includes initial frequency tolerance and temperature variation(except supply voltage variation, reflow drift, aging).

■ External dimensions

(Unit:mm) ■ Recommended soldering pattern (Unit:mm)

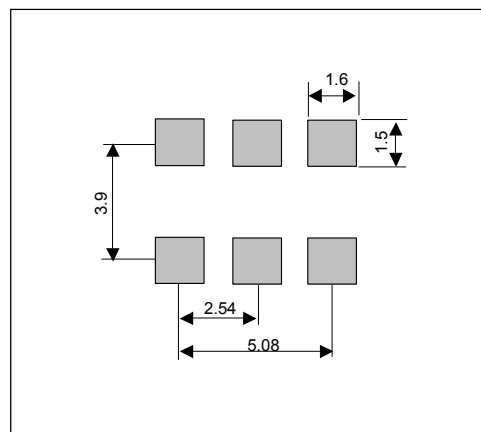
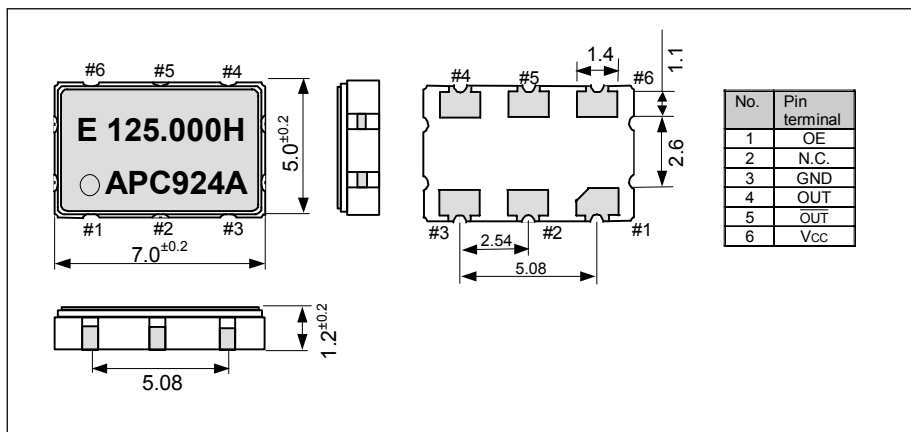

HIGH-STABILITY HIGH-FREQUENCY CRYSTAL OSCILLATOR

HG - 2150CA series

Product number (please contact us)
Q3514CA00xxxx00

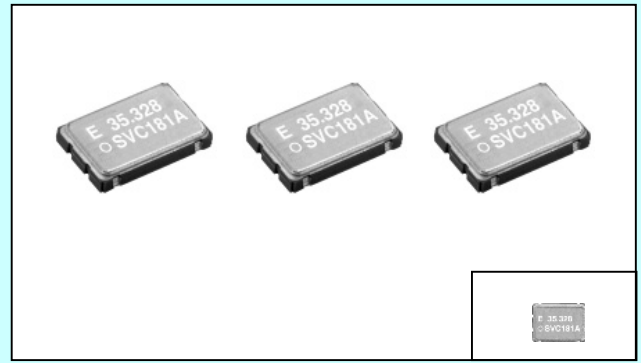

Actual size

- Frequency range : 1 MHz to 80 MHz
- Operating voltage : 3.3 V or 5.0 V
- Frequency stability : $\pm 15 \times 10^{-6}$ / -20 °C to +70 °C
- Function : Output enable(OE)
- Thickness : 1.5 mm Max.
- Lead(Pb)-free : Complies with EU RoHS directive (Lead free completely)

Specifications (characteristics)

Item	Symbol	Specifications		Remarks
		SVH / BXH	SVC / BXC	
Output frequency range	f_0	1.000 MHz to 80.000 MHz		60 MHz < f_0 ≤ 80 MHz Please contact us for inquiries
Operating voltage	V _{DD}	H:5.0 V ±0.5 V	C:3.3 V ±0.3 V	
Temperature range	Storage temperature	T _{STG} -40 °C to +125 °C		Stored as bare product after unpacking
	Operating temperature	T _{OPR} V:-20 °C to +70 °C X:-40 °C to +85 °C		
Frequency stability	$\Delta f/f_0$	S: $\pm 15 \times 10^{-6}$ *1		-20 °C to +70 °C
		B: $\pm 25 \times 10^{-6}$ *1		-40 °C to +85 °C
Current consumption	I _{OP}	30 mA Max.	25 mA Max.	No load condition, OE = V _{DD}
Output disable current	I _{OE}	15 mA Max.	12 mA Max.	OE=GND
Duty	tw/t	45 % to 55 %		50 % V _{DD}
High output voltage	V _{OH}	V _{DD} -0.4 V Min.		I _{OH} =-4 mA
Low output voltage	V _{OL}	0.4 V Max.		I _{OL} = 4 mA
Output load condition	C _L	15 pF Max.		CMOS load
Output enable input voltage	V _{IH}	70 % V _{DD} Min.		OE terminal
Output disable input voltage	V _{IL}	30 % V _{DD} Max.		OE terminal
Output rise and fall time	t _R / t _F	4 ns Max.		20 % V _{DD} to 80 % V _{DD}
Oscillation start up time	t _{OSC}	10 ms Max.		Time at minimum operating voltage to be 0 s.
Aging	f _a	$\pm 10 \times 10^{-6}$ Max. *2		T _a =+25 °C, 10 year

*1 Frequency stability includes variation in reflow soldering drift, operating temperature range, operating voltage range and load change.

*2 50 MHz < f_0 ≤ 80 MHz: $\pm 15 \times 10^{-6}$ Max.

External dimensions

(Unit:mm)

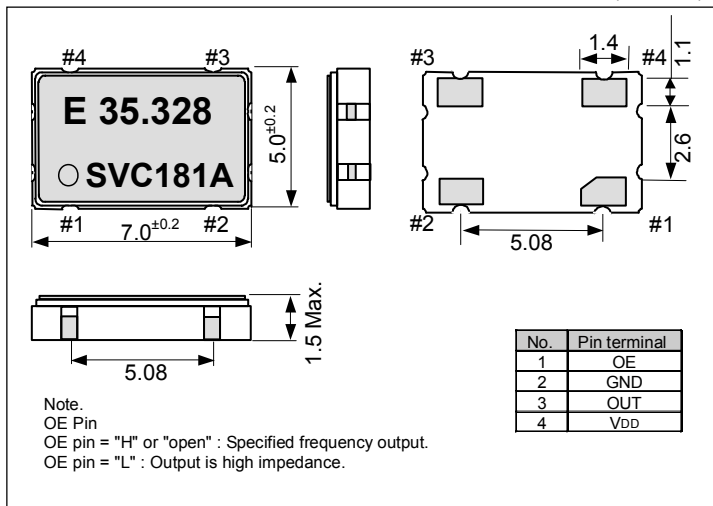

Recommended soldering pattern

(Unit:mm)

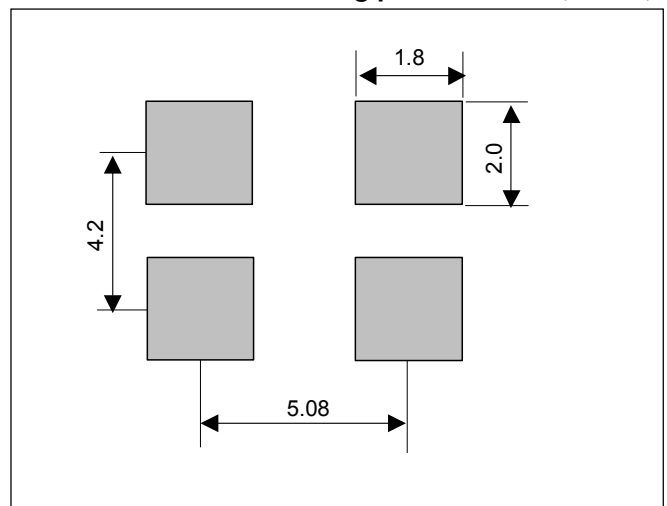

HIGH-STABILITY HIGH-FREQUENCY CRYSTAL OSCILLATOR

HG - 8002JA series

Product number (please contact us)

Q3502JAx1xxxx00

- Frequency range : 1 MHz to 125 MHz
- Operating voltage : 3.3 V or 5.0 V
- Frequency stability : $\pm 20 \times 10^{-6}$ / -20 °C to +70 °C
- Function : Output enable(OE) or Standby(\overline{ST})
- Thickness : 4.7 mm Max.
Package and pin compatible with SG-615.
- Lead(Pb)-free : Complies with EU RoHS directive

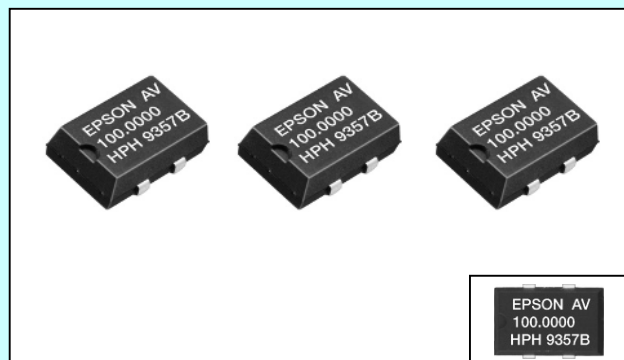

Actual Size

■ Specifications (characteristics)

Item	Symbol	Specifications			Remarks
		PT / ST	PH / SH	PC / SC	
Output frequency range	f_0	1.000 MHz to 125.000 MHz			
Operating voltage	V_{DD}	5.0 V \pm 0.25 V	3.3 V \pm 0.165 V		
Temperature range	Storage temperature	-55 °C to +125 °C			Stored as bare product after unpacking
	Operating temperature	-20 °C to +70 °C (-40 °C to +85 °C)		-40 °C to +85 °C	
Frequency stability	$\Delta f/f_0$	AV: $\pm 20 \times 10^{-6}$, BV: $\pm 25 \times 10^{-6}$ CX: $\pm 30 \times 10^{-6}$			AV, BV: -20 °C to +70 °C CX: -40 °C to +85 °C *1
Current consumption	I_{OP}	45 mA Max.		28 mA Max.	No load condition, Max. frequency
Output disable current	I_{OE}	30 mA Max.		16 mA Max.	OE=GND (PT, PH, PC)
Standby current	I_{ST}	50 μ A Max.			\overline{ST} =GND (ST, SH, SC)
Duty	tw/t	—		40 % to 60 %	CMOS load: 50% V_{DD} , Max. load condition
		40 % to 60 %		—	TTL load: 1.4V, Max. load condition
High output voltage	V_{OH}	V_{DD} -0.4 V Min.			I_{OH} = -16 mA (PT, ST, PH, SH), -8 mA (PC, SC)
Low output voltage	V_{OL}	0.4 V Max.			I_{OL} = 16 mA (PT, ST, PH, SH), 8 mA (PC, SC)
Output load condition (TTL)	N	2 TTL Max.	—		Max. frequency
Output load condition (CMOS)	C_L	15 pF Max.			Max. operating voltage
Output enable / disable input voltage	V_{IH}	2.0 V Min.		70 % V_{DD} Min.	\overline{ST} , OE terminal
	V_{IL}	0.8 V Max.		20 % V_{DD} Max.	\overline{ST} , OE terminal
Output rise and fall time	t_R / t_F	—		3 ns Max.	CMOS load: 20 % V_{DD} to 80 % V_{DD} level
		4 ns Max.		—	TTL load: 0.4 V to 2.4 V level
Oscillation start up time	t_{OSC}	10 ms Max.			Time at minimum operating voltage to be 0 s
Shock resistance	f_a	$\pm 2 \times 10^{-6}$ / year Max.			T_s =+25 °C, V_{DD} =5.0 V / 3.3 V (PC / SC)

PLL-PLL connection & Jitter specification, please refer to Page 41.

*1 PT, ST and PH, SH for "CX" stability will be available up to 55 MHz.

■ External dimensions

(Unit:mm)

■ Recommended soldering pattern

(Unit:mm)

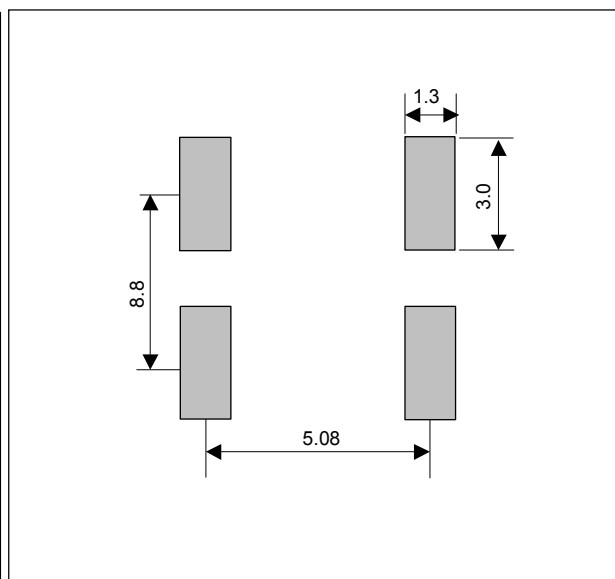
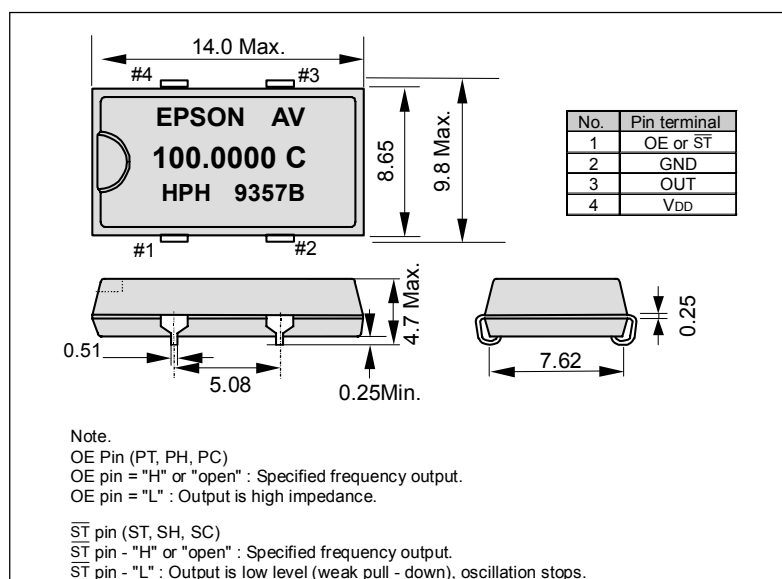

MULTI-OUTPUT CRYSTAL OSCILLATOR

32.768 kHz and 48 MHz

MG - 5020JE

Product number (please contact us)
Q33M22JE1xxx00

- Frequency range : 32.768 kHz and 48.00512 MHz
- Operating voltage : 32.768 kHz oscillation circuit 1.8 V to 3.6 V
 48 MHz oscillation circuit 2.7 V to 3.6 V.
- Built-in crystal : 32.768 kHz crystal unit
- Thickness : 1.5 mm Max.
- Lead(Pb)-free : Comply with EU RoHS directive.

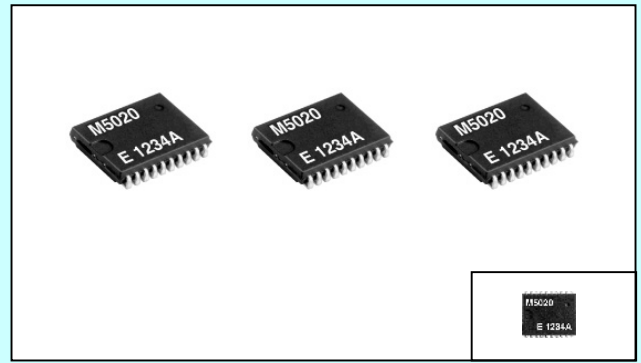

Actual size

Specifications (characteristics)

Item	Symbol	Specifications	Remarks
Output frequency range	f_0	32.768 kHz 48.005120 MHz	OUT32k - pin OUT - pin
Max. supply voltage	V _{DD} -GND	-0.3 V to +4.5 V	
Operating voltage	V _{DD} V _{BK}	2.7 V to 3.6 V 1.8 V to 3.6 V	PLL Output 32.768 kHz Output
Storage temperature	T _{STG}	-55 °C to +125 °C	Stored as bare product after unpacking
Operating temperature	T _{OPR}	-40 °C to +85 °C	
Frequency stability	$\Delta f/f_0$	$5 \pm 23 \times 10^{-6}$	T _a =+25 °C, V _{DD} =3.0 V
Current consumption 1 (PLL Stopping)	I _{OP1}	3 μ A Max.	V _{DD} =1.8 V to 3.6 V PWD =GND OUT32 k=No load condition
Current consumption 2 (PLL Working)	I _{OPP}	15 mA Max.	V _{DD} =2.7 V to 3.6 V PWD =HIGH OUT= No load condition
Duty	tw/t	40 % to 60 %	50 % V _{DD}
High output voltage	V _{OH}	V _{DD} -0.4 V Min.	I _{OH} =100 μ A(OUT32k), 4.0 mA(OUT)
Low output voltage	V _{OL}	0.4 V Max.	I _{OL} =-100 μ A(OUT32k), -4.0 mA(OUT)
Output condition	CL	15 pF Max.	OUT32k pin, OUT pin
Output enable input voltage	V _{IH}	80 % V _{DD} to V _{DD} +0.2 V	PWD pin
Output disable input voltage	V _{IL}	GND-0.2 V to 0.2 V _{DD}	PWD pin
Output rise time	t _R	5 ns Max.	20 %→80 % V _{DD} , OUT pin
Output fall time	t _F	5 ns Max.	80 %→20 % V _{DD} , OUT pin
Jitter	P _J	150 ps Max.	V _{DD} =2.7 V to 3.6 V Period jitter
Oscillation start up time	t _{STAI} t _{STAP}	3 s Max. 0.1 s	T _a =+25 °C, V _{DD} =0 V→1.8 V to 3.6 V V _{DD} =0 V → 2.7 V to 3.6 V, PWD=LOW→High
Aging	fa	$\pm 5 \times 10^{-6}$ / year Max.	T _a =+25 °C, V _{DD} = 3.0 V, First year

Block diagram

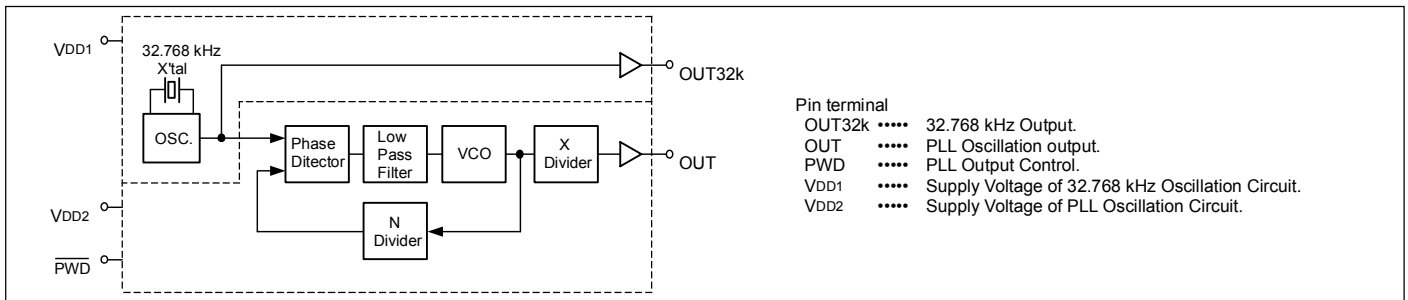

External dimensions

(Unit:mm)

Recommended soldering pattern

(Unit:mm)

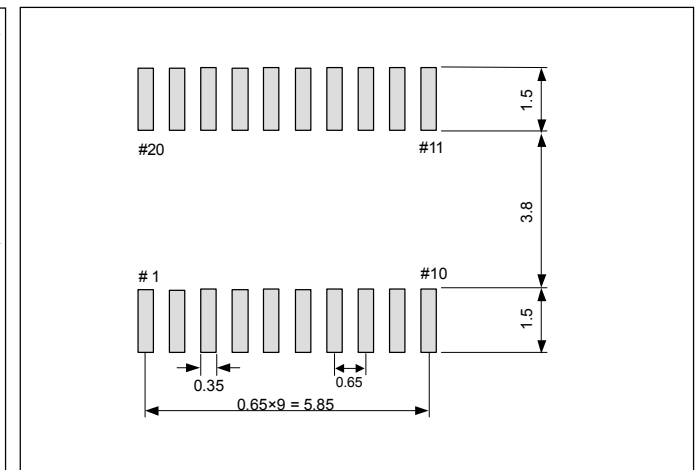
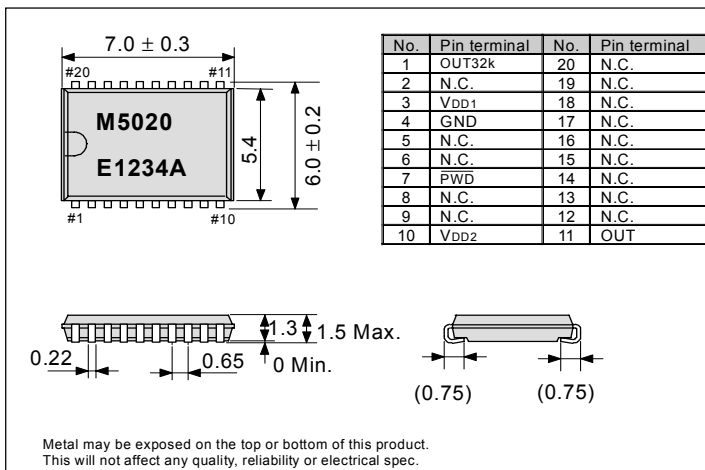

MULTI-OUTPUT CRYSTAL OSCILLATOR

MG - 5100SA series

Product number (Please contact us)
Q33M21SA1xxxxx00

- Frequency range : 76.9 kHz to 100 MHz
- Operating voltage : 3.3 V or 5.0 V
- Built-in crystal : AT crystal unit
- Thickness : 3.2 mm Typ.
- Lead(Pb)-free : Complies with EU RoHS directive
- Available output in 8 frequencies by select pin for CPUCLK.

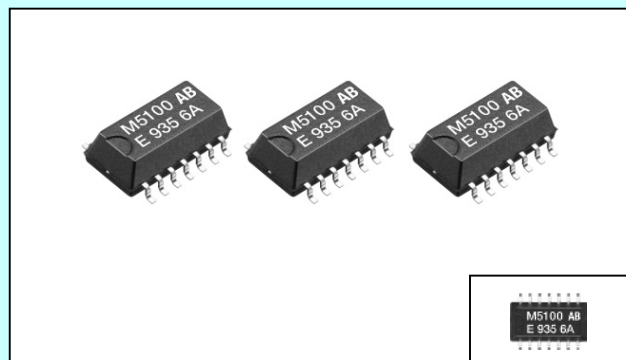

Actual size

■ Specifications (characteristics)

Item	Symbol	Specifications		Remarks
		V _{DD} =5.0V	V _{DD} =3.3V	
Output frequency range	f ₀	76.9 kHz to 100 MHz	76.9 kHz to 80 MHz	Please contact us for inquiries regarding available frequencies.
Power source voltage	Max. supply voltage	-0.3 V to +7.0 V		
	Operating voltage	V _{DD}		
Temperature range	Storage temperature	-55 °C to +100 °C		Stored as bare product after unpacking
	Operating temperature	T _{OPR}		
Frequency stability	Δf/f ₀	±100 × 10 ⁻⁶		
Current consumption	I _{OP}	100 mA Max.	65 mA Max.	No load, Max. frequency
Duty	tw/t	40 % to 60 %		CMOS load: 50 % V _{DD} , CL=15 pF
High output voltage	V _{OH}	V _{DD} -0.4 V Min.		I _{OH} =-4 mA
Low output voltage	V _{OL}	0.4 V Max.		I _{OL} =4 mA
Output condition	CL	25 pF Max.	15 pF Max.	Max. frequency and Max. operating voltage
Output enable / disenable input voltage	V _{IH}	80 % V _{DD} Min.		
	V _{IL}	20 % V _{DD} Max.		
Output rise time	t _R	5 ns Max.		20 % → 80 % V _{DD}
Output fall time	t _F	4 ns Max.		80 % → 20 % V _{DD}
Jitter	t _j	450 ps Max.		Cycle to Cycle jitter
		500 ps Max.		Peak to Peak jitter
Skew	t _{skw}	500 ps Max		Please contact us for inquiries about details.
Oscillation start up time	t _{OSC}	70 ms Max.		Time at minimum operating voltage to be 0s.
Aging	f _a	±5 × 10 ⁻⁶ / year Max.		T _a =+25 °C, V _{DD} =5.0 V / 3.3 V, First year

■ Block diagram

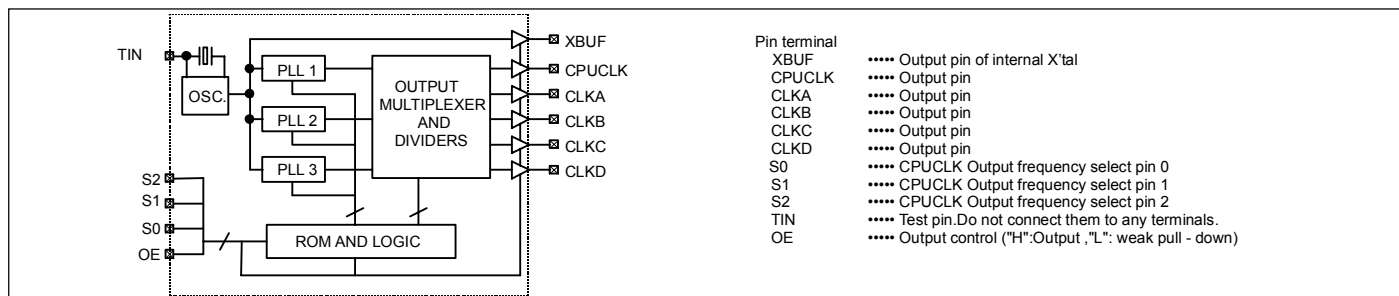

■ External dimensions

(Unit:mm)

■ Recommended soldering pattern

(Unit:mm)

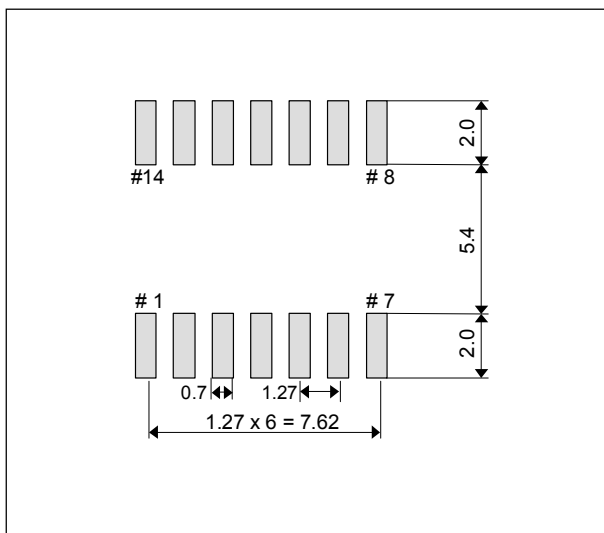
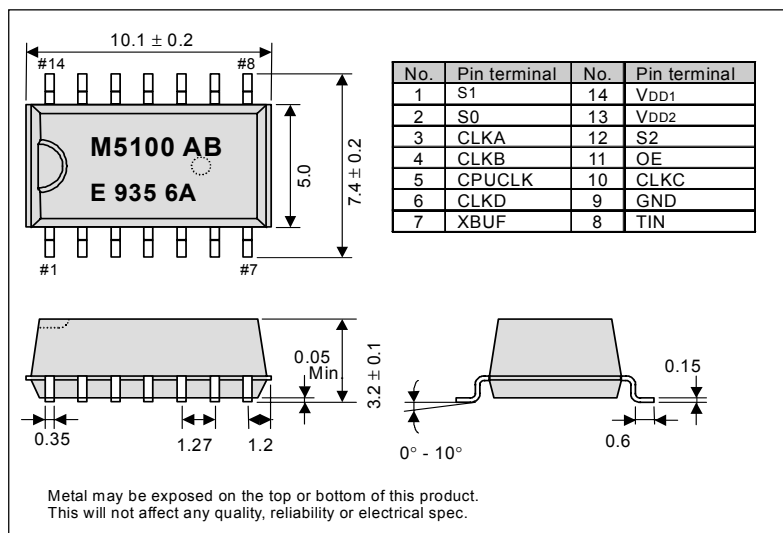

VOLTAGE –CONTROLLED CRYSTAL OSCILLATOR VCXO (Wide pull range) VG - 4231CA

Product number (please contact us)
Q3614CA00xxx00

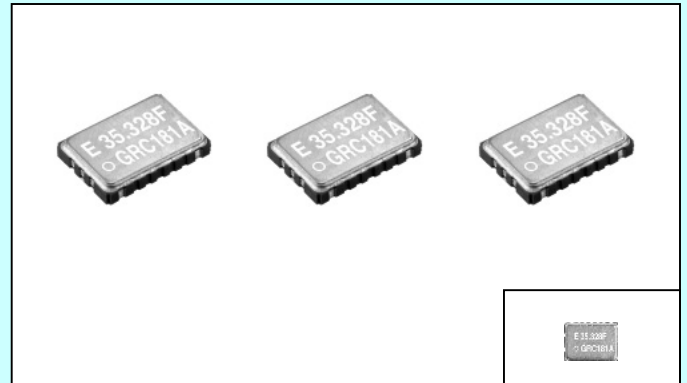

Actual size

- Frequency range : 1 MHz to 75 MHz
- Operating voltage : 3.3 V (DRC,GRC)
5.0 V (DRH,GRH)
- Pull range : $\pm 130 \times 10^{-6}$
- Thickness : 1.4 mm Typ.
- Lead(Pb)-free : Complies with EU RoHS directive
(Lead free completely)

Specifications (characteristics)

Item	Symbol	Specifications		Remarks
		DRH / GRH	DRC / GRC	
Output frequency range	f_0	1.000 MHz to 60.000 MHz	1.000 MHz to 75.000 MHz	Please contact us for inquiries regarding available frequencies.
Power source voltage	Operating voltage	V_{DD}	H:5.0 V ± 0.5 V C:3.3 V ± 0.3 V	
Temperature range	Storage temperature	T_{STG}	-40 °C to +125 °C	Stored as bare product after unpacking
	Operating temperature	T_{OPR}	As per below table	
Frequency stability	$\Delta f/f_0$	As per below table		$V_C=2.5$ V(DRH,GRH)/ $V_C=1.65$ V(DRC,GRC)
Current consumption	I_{OP}	20 mA Max.	10 mA Max.	No load condition
Output disable current	I_{OE}	15 mA Max.	7 mA Max.	OE=GND
Pull range	Δf_c	R: $\pm 130 \times 10^{-6}$ (1 MHz< f_0 ≤42 MHz) Q: $\pm 120 \times 10^{-6}$ (42 MHz< f_0 ≤75 MHz)		$V_C=2.5$ V ± 2.0 V(DRH,GRH) $V_C=1.65$ V ± 1.5 V(DRC,GRC)
Absolute pull range *1	APR	DR: $\pm 80 \times 10^{-6}$ Min., GR: $\pm 65 \times 10^{-6}$ Min.		Pull range: $\pm 130 \times 10^{-6}$
Modulation characteristics	BW	15 kHz Min.		± 3 dB (at 1kHz)
Input resistance	Z_{IN}	50 k Ω Min.		DC Level
Frequency change polarity		Positive polarity		$V_C=0.5$ V to 4.5 V(**H) , 0.15 V to 3.15 V(**C)
Duty	tw/t	40 % to 60 %		CMOS load:50 % V_{DD} level
High output voltage	V_{OH}	$V_{DD}-0.4$ V Min.		$I_{OH}=-0.8$ mA(DRC,GRC), $I_{OH}=-4$ mA(DRH,GRH)
Low output voltage	V_{OL}	0.4 V Max.		$I_{OL}= 3.2$ mA(DRC,GRC), $I_{OL}= 4$ mA(DRH,GRH)
Output load condition	C_L	15 pF Max.		CMOS load
Output enable / disable input voltage	V_{IH} V_{IL}	70 % V_{DD} Min. 30 % V_{DD} Max.		OE Terminal
Output rise and fall time	t_R / t_F	4 ns Max.		CMOS load: 20 % V_{DD} level to 80 % V_{DD} level
Oscillation start up time	t_{OSC}	10 ms Max.		Time at 90% V_{DD} to be 0 s
Aging	f_a	$\pm 10 \times 10^{-6}$ Max. *2		$T_a=+25$ °C, 10 years

*1 Absolute pull range = Pull range - (Frequency stability + 10 years Aging + Free fall + Vibration)

*2 50 MHz < f_0 ≤ 75 MHz : $\pm 15 \times 10^{-6}$ Max.

Stability / Temperature range

	Stability	Temperature range
DRC / DRH / DQC	$\pm 35 \times 10^{-6}$	-20 °C to +70 °C
GRC / GRH / GQC	$\pm 50 \times 10^{-6}$	-40 °C to +85 °C

External dimensions

(Unit:mm)

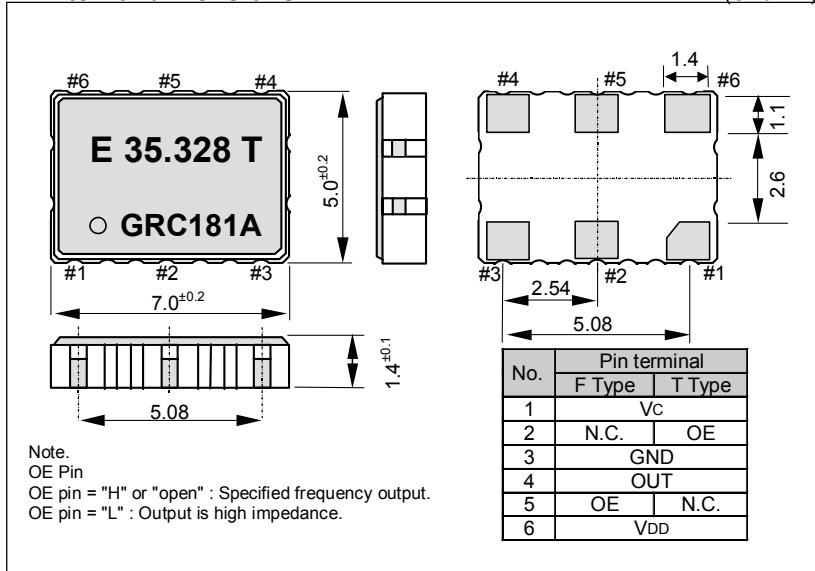

Recommended soldering pattern

(Unit:mm)

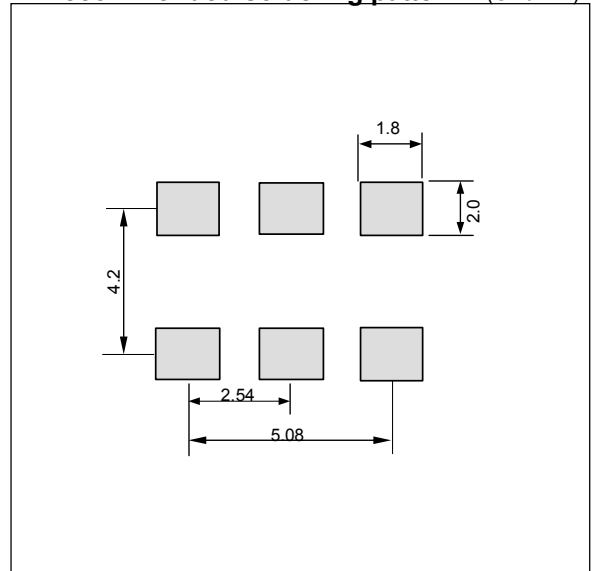

VOLTAGE –CONTROLLED CRYSTAL OSCILLATOR

VCXO

VG-1201CA

Product number (please contact us)

Q3603CA0xxxx00

- Frequency range : 1 MHz to 80 MHz
- Operating voltage : 3.3 V(**C) or 5.0V(**H)
- Function : Output enable(OE)
- Thickness : 1.4 mm Typ.
- Lead(Pb)-free : Complies with EU RoHS directive (Lead free completely)

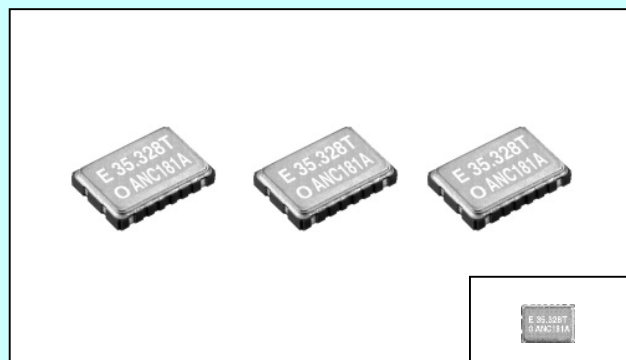

Actual size

■ Specifications (characteristics)

Item	Symbol	Specifications		Remarks
		ANH / AKH / BNH / BKH	ANC / AKC / BNC / BKC	
Output frequency range	f_0	1.000 MHz to 80.000 MHz		60 MHz < f_0 ≤ 80 MHz Please contact us for inquiries *1
Power source voltage	Operating voltage	V_{DD}	H:5.0 V ±0.5 V C:3.3 V ±0.3 V	
Temperature range	Storage temperature	T_{STG}	-40 °C to +125 °C	Stored as bare product after unpacking
	Operating temperature	T_{OPR}	As per below table	
Frequency stability	$\Delta f/f_0$	As per below table		
Current consumption	IOP	30 mA Max.	25 mA Max.	No load condition
Output disable current	IOE	15 mA Max.	12 mA Max.	OE=GND
Pull range	Δf_c	As per below table		$V_c=2.5 \text{ V} \pm 2.0 \text{ V(**H)}$, $1.65 \text{ V} \pm 1.50 \text{ V(**C)}$
Modulation characteristics		20 kHz Min.		± 3 dB (at 1kHz)
Input resistance	Z_{IN}	5 MΩ Min.		DC Level
Frequency change polarity		Positive polarity		$V_c=0.5 \text{ V}$ to 4.5 V(**H) , 0.15 V to $3.15 \text{ V}(□□C)$
Duty	tw/t	40 % to 60 %		CMOS load:50 % V_{DD} level
High output voltage	V_{OH}	$V_{DD}-0.4 \text{ V}$ Min.		IOH=-4 mA
Low output voltage	V_{OL}	0.4 V Max.		IOL= 4 mA
Output load condition	C_L	15 pF Max.		CMOS load
Output enable / disable input voltage	V_{IH}	70 % V_{DD} Min.		OE Terminal
	V_{IL}	30 % V_{DD} Max.		
Output rise and fall time	t_r / t_f	4 ns Max.		CMOS load: 20 % to 80 % V_{DD} level
Oscillation start up time	t_{OSC}	10 ms Max.		Time at 0.9 V_{DD} to be 0 s
Aging	fa	±10 × 10 ⁻⁶ Max. *2		Ta=+25 °C, 10 years

*1 Please contact us for inquiries about operating temperature, frequency stability, pull range.

*2 50 MHz < f_0 ≤ 80 MHz : ±15 × 10⁻⁶ Max.

■ Stability / Temperature range

	Stability	Temperature range
A	±20 × 10 ⁻⁶	-20 °C to +70 °C
B	±25 × 10 ⁻⁶	-40 °C to +85 °C

■ Pull range

	Pull range	Output frequency range
G	±50 × 10 ⁻⁶ Min	70 MHz < f_0 ≤ 80 MHz (3.3 V)
K	±75 × 10 ⁻⁶ Min	41 MHz < f_0 ≤ 80 MHz (5.0V) 41 MHz < f_0 ≤ 70 MHz (3.3V)
N	±100 × 10 ⁻⁶ Min	1 MHz ≤ f_0 ≤ 41 MHz

■ External dimensions

(Unit:mm) ■ Recommended soldering pattern (Unit:mm)

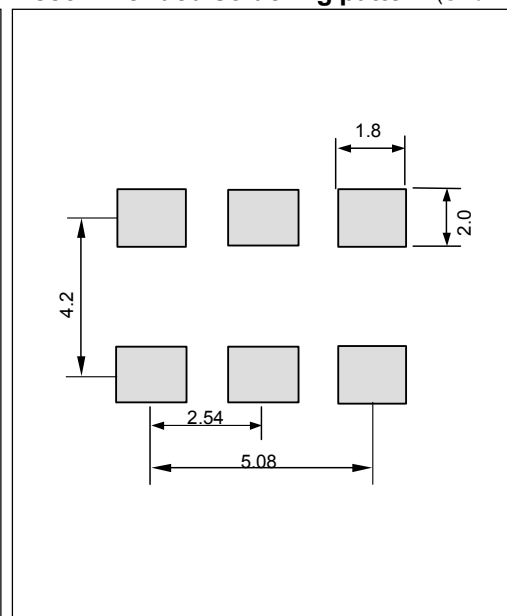
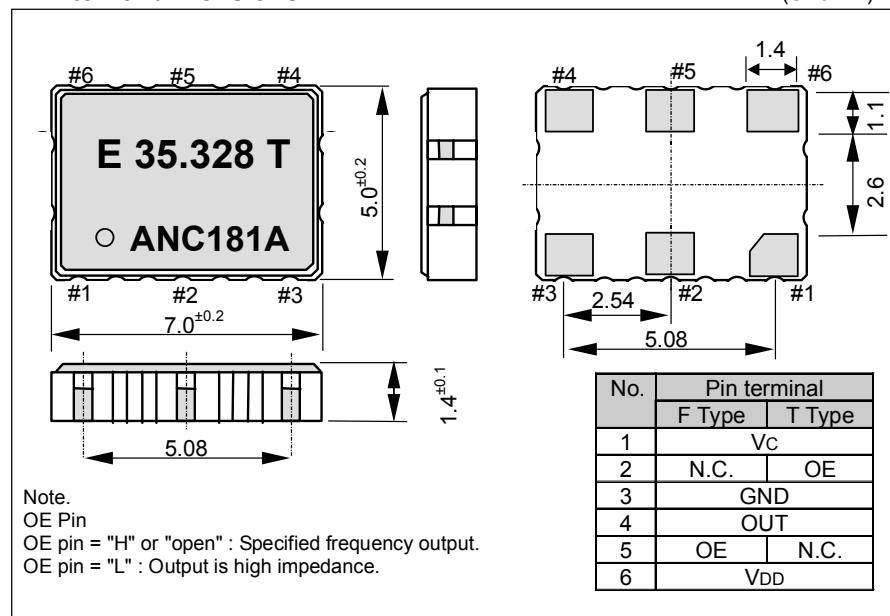

VOLTAGE –CONTROLLED CRYSTAL OSCILLATOR

VCXO

VG - 4030JA

Product number (please contact us)

Q3612JA01xxxx00

- Frequency range : 2 MHz to 28.63636 MHz
- Operating voltage : 3.3 V
- Pull range : 150×10^{-6} or 180×10^{-6} / $V_c=0.0$ to 3.0 V
- Thickness : 4.7 mm Max.
- Lead(Pb)-free : Complies with EU RoHS directive

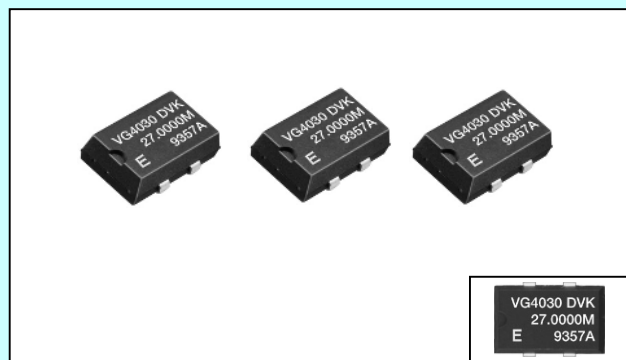

Actual size

■ Specifications (characteristics)

Item	Symbol	Specifications	Remarks	
		DVK		
Output frequency range	f_0	2.000 MHz to 28.63636 MHz	Please contact us for inquiries regarding available frequencies.	
Operating voltage	V_{DD}	3.3 V \pm 0.17 V		
Temperature range	Storage temperature	TSTG	-55 °C to +125 °C	Stored as bare product after unpacking
	Operating temperature	TOPR	-20 °C to +70 °C	
Frequency stability	$\Delta f/f_0$	$\pm 37 \times 10^{-6}$ Max.	$V_c=1.8$ V	
Current consumption	I_{OP}	18 mA Max.	No load condition	
Pull range	Δf_c	150×10^{-6} or 180×10^{-6}	$V_c=0.0$ to 3.0 V (Please contact us.)	
Input resistance	Z_{IN}	10 M Ω Min.	DC Level	
Frequency change polarity		Positive polarity	$V_c=0.0$ to 3.0 V	
Duty	tw/t	40 % to 60 %	CMOS load:50 % V_{DD} level	
High output voltage	V_{OH}	$V_{DD}-0.4$ V Min.	$I_{OH}=-0.8$ mA	
Low output voltage	V_{OL}	0.4 V Max.	$I_{OL}= 3.2$ mA	
Output load condition	C_L	30 pF Max.	CMOS load	
Output rise and fall time	t_{r} / t_{f}	6 ns Max.	CMOS load: 20 % V_{DD} level to 80 % V_{DD} level	
Oscillation start up time	t_{osc}	10 ms Max.	Time at minimum operating voltage to be 0 s	
Aging	f_a	$\pm 5 \times 10^{-6}$ / year Max.	$T_a=+25$ °C, $V_{DD}=3.3$ V, First year	

*Give the V_c voltage at the time of the power supply input as GND or Open without fail.

■ External dimensions

(Unit:mm) ■ Recommended soldering pattern (Unit:mm)

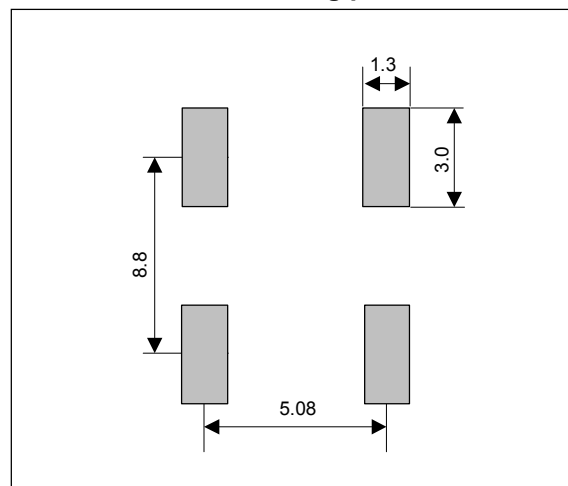
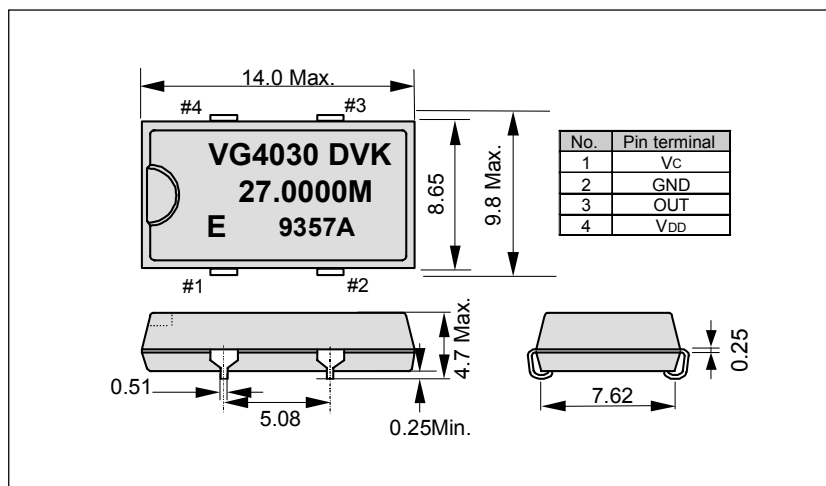

VOLTAGE –CONTROLLED CRYSTAL OSCILLATOR VCXO

VG-2828CB

Product number (please contact us)
Q3623CB00xxx00

- Frequency range : 13 MHz
- Operating voltage : 2.8 V
- Thickness : 1.2 mm Typ.
- Applications : GSM
- Low noise : -143 dBc/Hz Typ. at 1 kHz offset
- Lead(Pb)-free : Complies with EU RoHS directive (Lead free completely)

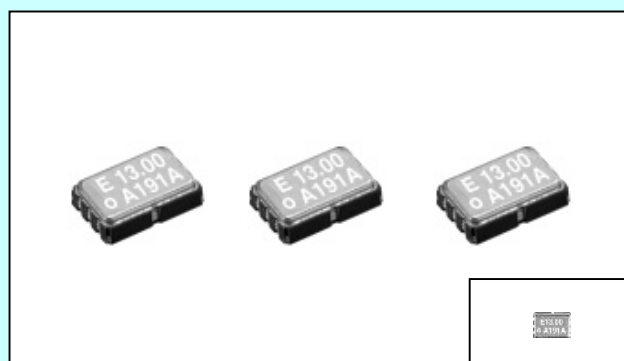

Actual size

■ Specifications (characteristics)

Item	Symbol	Specifications	Remarks
Output frequency range	f_0	13.000 MHz	
Power source voltage	Max. supply voltage	V_{CC-GND}	-0.3 V to +7.0 V
	Operating voltage	V_{CC}	2.8 V \pm 0.1 V
Temperature range	Storage temperature	T_{STG}	-40 °C to +85 °C
	Operating temperature	T_{OPR}	-20 °C to +75 °C
Frequency stability	$\Delta f/f_0$	$\pm 12 \times 10^{-6}$ Max. *	
Frequency control range	Δf_c	$\pm 12 \times 10^{-6}$ Min.	$V_C=1.0$ V(center), 0.06 V, 2.0 V
Frequency change polarity		Positive polarity	
Input resistance	Z_{IN}	10 M Ω Min.	V_C-GND (DC)
Current consumption	I_{CC}	1.0 mA Max.	10 k Ω //10 pF, $V_{CC}=2.8$ V
Duty	tw/t	30 % to 70 %	GND Level (DC cut)
Output voltage	V_{OUT}	0.8 V Min.	Peak to Peak
Output load condition	RL/CL	10 k Ω //10 pF	Please contact us for other Output load. DC cut capacitor =0.01 μ F

* Include initial frequency tolerance, reflow shift, temperature variation, supply voltage variation, load variation and aging.

Note:Please contact us for inquiries about specifications other than the above.

■ External dimensions

(Unit:mm) ■ Recommended soldering pattern (Unit:mm)

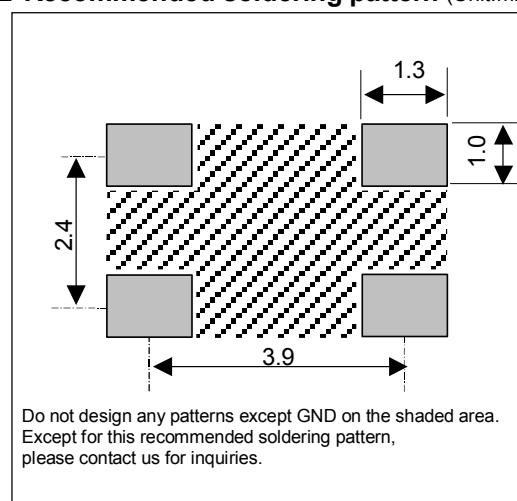
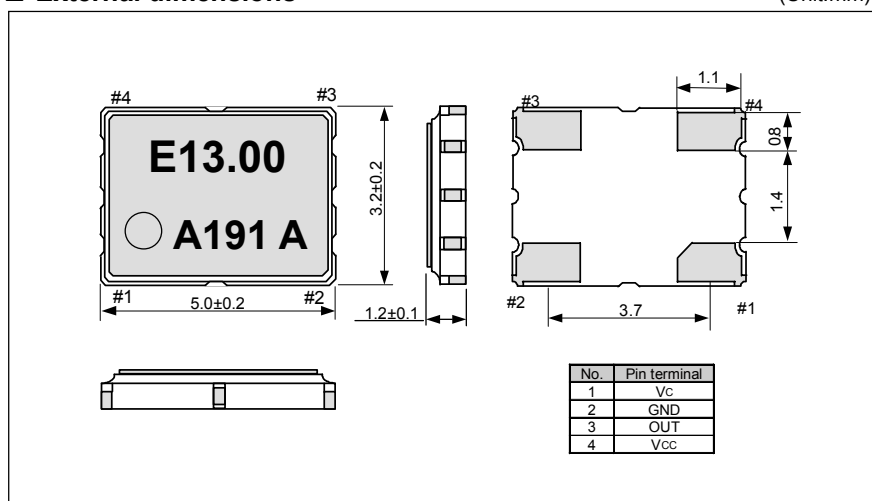

32 kHz TCXO

TG-3530 SA

Product Number (please contact us)
TG-3530 SA : Q3721SA01xxxx00

- Built-in 32.768 kHz crystal oscillator with high accuracy. (adjustment-free efficient operation)
- Temperature compensated circuit : Stabilized frequency tolerance at any operating temperature.
- Oscillation output voltage : 1.5 V to 5.5 V
- Temperature Compensated Voltage : 2.2 V to 5.5 V
- 32.768 kHz output : C-MOS output, output load : CL = 15 pF
- Complies with EU RoHS directive

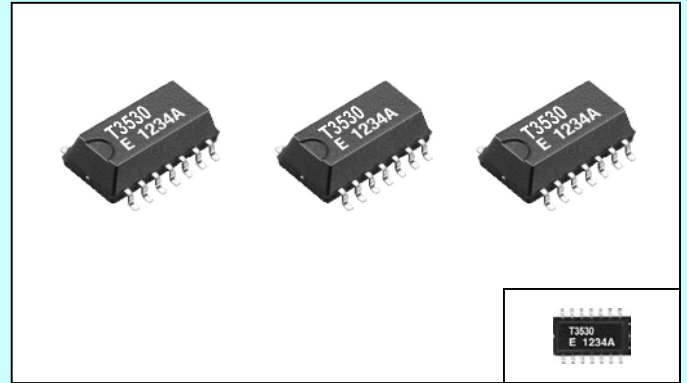

Actual size

Specifications (characteristics)

Item	Symbol	Specifications	Condition
Output frequency	f_o	32.768 kHz	
Max. supply voltage	$V_{DD} - GND$	-0.3 V to +7.0 V	
Oscillation output voltage	V_{DD}	1.5 V to 5.5 V	
Temperature compensated voltage	V_{DD}	2.2 V to 5.5 V	
Storage temperature	T_{STG}	-55 °C to +125 °C	Stored as bare product after unpacking
Operating temperature	T_{OPR}	-40 °C to +85 °C	Operating temperature
Frequency tolerance	$\Delta f / f$	$\pm 3.8 \times 10^{-6}$ * Equivalent to 10 seconds of monthly deviation	$T_a = -10 \text{ }^\circ\text{C}$ to $+60 \text{ }^\circ\text{C}$ $V_{DD} = 3.0 \text{ V}$
		$\pm 5.0 \times 10^{-6}$ * Equivalent to 13 seconds of monthly deviation	$T_a = -20 \text{ }^\circ\text{C}$ to $+70 \text{ }^\circ\text{C}$ $V_{DD} = 3.0 \text{ V}$
Frequency voltage characteristics	f / V	$\pm 1.0 \times 10^{-6} / \text{V}$ Max.	$T_a = +25 \text{ }^\circ\text{C}$ $V_{DD} = 2.2 \text{ V}$ to 5.5 V
Current consumption	I_{DD}	6.0 μA (Max.) 3.0 μA (Typ.)	$V_{DD} = 5.0 \text{ V}$, No load condition
		4.0 μA (Max.) 1.7 μA (Typ.)	$V_{DD} = 3.0 \text{ V}$, No load condition
Output voltage ("H" level)	V_{OH}	$V_{DD} - 0.4 \text{ V}$ Min.	$I_{OH} = -0.1 \text{ mA}$ $V_{DD} = 3.0 \text{ V}$
Output voltage ("L" level)	V_{OL}	0.4 V Max.	$I_{OL} = 0.1 \text{ mA}$ $V_{DD} = 3.0 \text{ V}$
Output load condition	C_L	15 pF Max.	CMOS load
Duty	t_w / t	40 % to 60 %	$V_{DD} = 1.5 \text{ V}$ to 5.5 V 1 / 2 V_{DD} level
Output rise time	t_{TLH}	200 ns Max.	CMOS load 20 % V_{DD} \rightarrow 80 % V_{DD}
Output fall time	t_{THL}	200 ns Max.	CMOS load 80 % V_{DD} \rightarrow 20 % V_{DD}
Oscillation start-up time	t_{osc}	1.0 s Max. *1)	$T_a = +25 \text{ }^\circ\text{C}$ $V_{DD} = 3.0 \text{ V}$
		3.0 s Max. *1)	$T_a = -40 \text{ }^\circ\text{C}$ to $+85 \text{ }^\circ\text{C}$ $V_{DD} = 3.0 \text{ V}$
Aging	f_a	$\pm 3.0 \times 10^{-6} / \text{year}$	$T_a = +25 \text{ }^\circ\text{C}$ $V_{DD} = 3.0 \text{ V}$, first year

*1) V_{DD} rise time < 10ms (10 % V_{DD} - 90 % V_{DD})

*2) If not specifically indicated, $T_a = -40 \text{ }^\circ\text{C}$ to $+85 \text{ }^\circ\text{C}$.

Frequency temperature characteristics (Ex.)

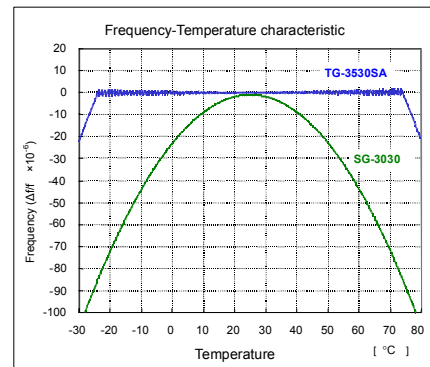

Terminal connection

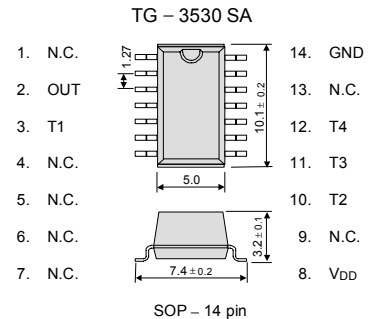

Signal Name	Input / Output	Function
V_{DD}	—	Connected to a positive power supply.
OUT	OUTPUT	32.768 kHz clock output pin (C-MOS).
GND	—	Connected to a ground.
T1, T2 T3, T4	—	* Used by the manufacture for testing. (Do not connect externally.)

REAL TIME CLOCK IC. For TG-3530SA

RX-4574 SG

Product Number (please refer to Application guide)
RX-4574 SG : Q414574Bxxxxx00

- By combining TG-3530SA with RX-4574SG (real-time clock IC), it is possible to achieve a ver high accuracy clock system.
- Functions are compatible with RX-4574 LC and RTC-4574 series (except 32 kHz oscillation function).
- Complies with EU RoHS directive

Note) RX-4574SG does not include the crystal unit.
 The external clock resources (C-MOS) of 32.768 kHz are necessary.
 Please input it from the XIN terminal.

Terminal connection

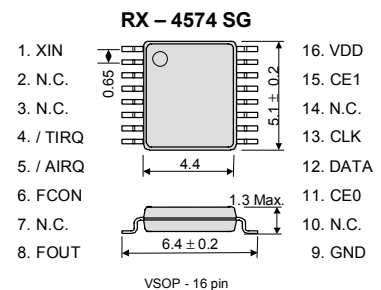

TCXO

TG - 5001LA

Product number (please contact us)
Q3712LA00xxxx00

- Frequency range : 13 MHz , 19.2 MHz, 26 MHz, 38.4MHz
- Operating voltage : 2.8 V Typ.
- Thickness : 1.15 mm Typ.
- Applications : GSM, CDMA, WCDMA
- Lead(Pb)-free : Complies with EU RoHS directive
(Lead free completely)

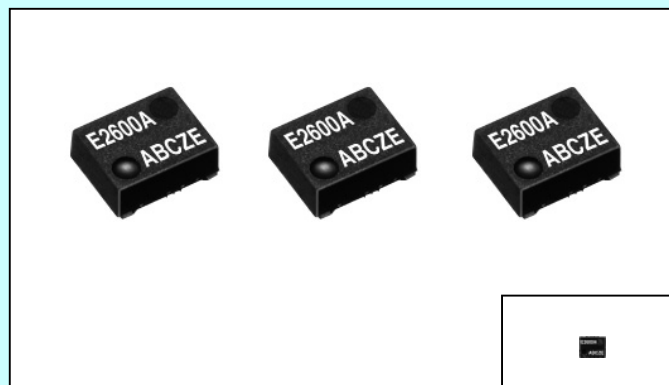

Actual size

■ Specifications (characteristics)

Item	Symbol	Specifications	Remarks
Output frequency	f_0	13 MHz, 19.2 MHz, 26 MHz, 38.4 MHz	
Power source voltage	Max. supply voltage	V_{CC-GND}	-0.3 V to +4.5 V
	Operating voltage	V_{CC}	2.8 V \pm 0.14 V
Temperature range	Storage temperature	T_{STG}	-40 °C to +85 °C
	Operating temperature	T_{OPR}	-30 °C to +85 °C
Frequency tolerance	Δf_0	$\pm 2.5 \times 10^{-6}$ Max.	$V_C=1.4$ V, +25 °C ± 2 °C
Frequency stability vs. temperature	Δf_T	$\pm 2.0 \times 10^{-6}$ Max.	-30 °C to +85 °C ($T_a=+25$ °C)
Frequency stability vs. load	Δf_L	$\pm 0.2 \times 10^{-6}$ Max.	10 k Ω // 10 pF ± 10 %
Frequency stability vs. supply voltage	Δf_V	$\pm 0.3 \times 10^{-6}$ Max.	2.8 V ± 5 %
Aging	f_a	$\pm 1.0 \times 10^{-6}$ Max.	$T_a=+25$ °C, first year
Current consumption	I_{CC}	1.5 mA Max.	19.2 MHz, $V_{CC}=2.8$ V, 10 k Ω // 10pF
Input resistance	Z_{IN}	800 k Ω Min.	V_C - GND (DC), $V_C=1.4$ V
Frequency control range	Δf_C	$\pm 5.0 \times 10^{-6}$ to $\pm 12.0 \times 10^{-6}$	$V_C=1.4$ V ± 1.0 V
Frequency change polarity		Positive polarity	
Duty	tw/t	40 % to 60 %	GND level (DC cut)
Output level	V_{OUT}	0.8 V Min.	Peak to peak
Output load	R_L/C_L	10 k Ω // 10 pF	Please contact us for other Output load. DC cut capacitor = 0.01 μ F

Note: Please contact us for inquiries about specifications other than the above.

■ External dimensions

(Unit:mm) ■ Recommended soldering pattern (Unit:mm)

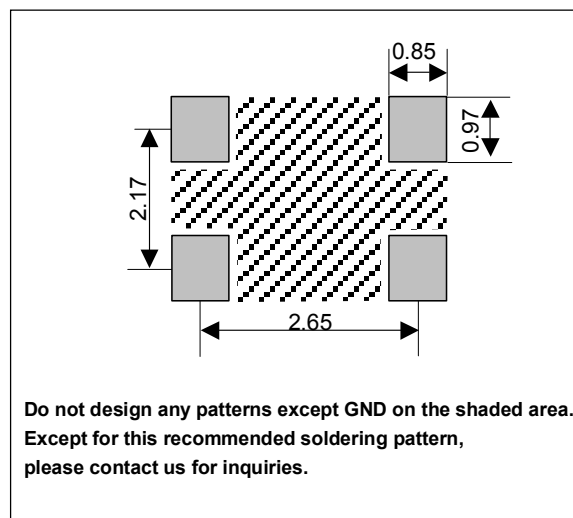
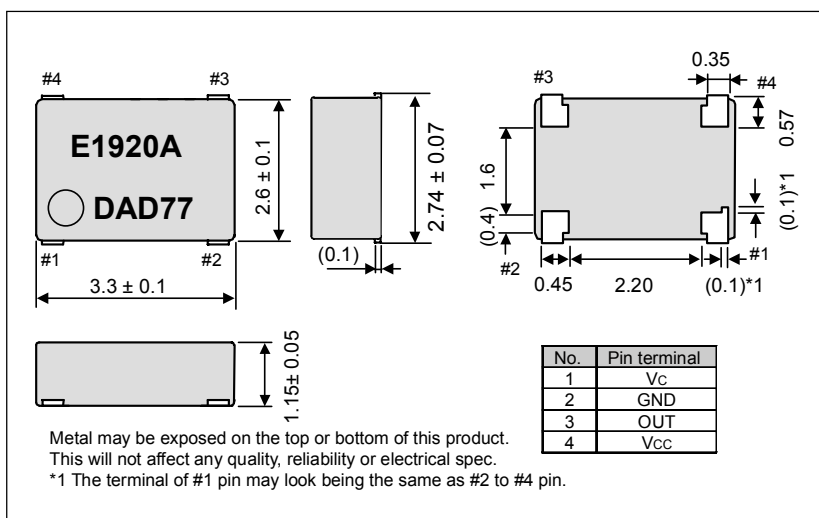

High-Stability Frequency

SERIAL-INTERFACE REAL TIME CLOCK MODULE

RX-4045 SA/NB

Product Number (please contact us)

RX-4045 SA : Q41404551xxxx00

RX-4045 NB : Q41404591xxxx00

- Built-in 32.768 kHz quartz oscillator : Frequency adjusted for high accuracy. ($\pm 5 \times 10^{-6} / T_a = +25^\circ\text{C}$)
- Interface Type : 4 wire high accuracy serial interface
- Operating voltage range : 1.7 V to 5.5 V
- Wide Timekeeper voltage range : 1.15 V to 5.5 V
- Various detection Functions : Oscillation stop detection function etc.
- Low backup current : 0.48 μA / 3 V (Typ.)
- 32.768kHz clock frequency output : Open drain output
- Function of time and calendar, the various detection function, and interrupt function etc.
- Complies with EU RoHS directive

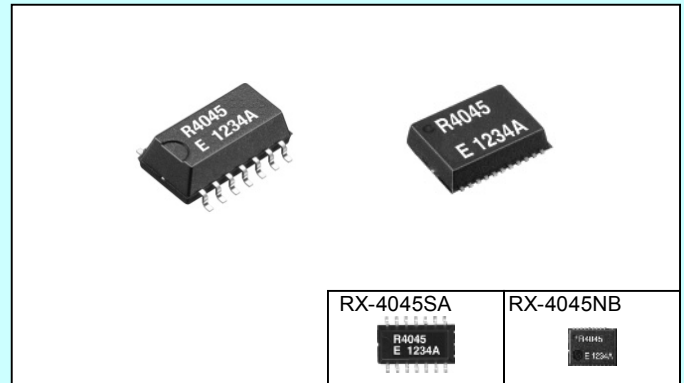

Actual size

* Refer to application manual for details.

<http://www.epsondevice.com>

Block diagram

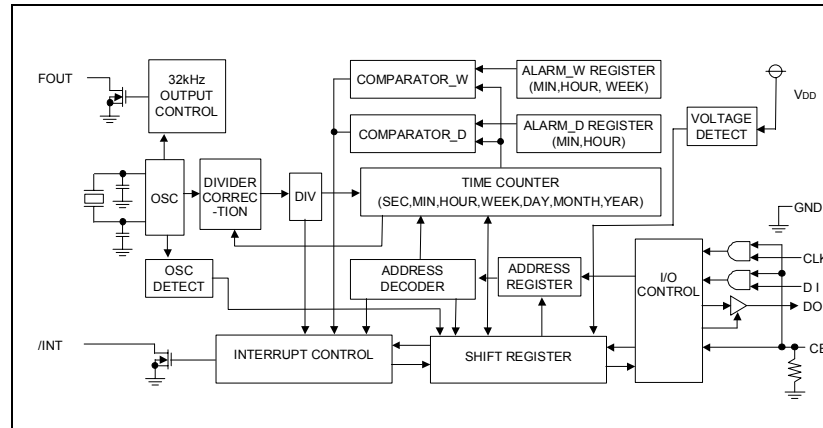

Overview

- **Features built-in 32.768 kHz quartz oscillator**
 - Frequency adjusted for high precision ($\pm 5 \times 10^{-6} / T_a = +25^\circ\text{C}$) (Equivalent to 13 seconds of monthly deviation)
- **The various detection Function**
 - Power supply voltage monitoring function (with selectable detection threshold)
 - Stop detection function
 - Power-on reset detection function
- **Equipped with alarm and timer**
 - Timer function produces a periodic interruption signal. As for the Alarm function an optional combination is produced. (Date of the week, time, minute)

Pin function

Signal Name	Input / Output	Function
CE	Input	The chip enabled input pin. (built-in pull-down resistance) At the "H" level, access becomes possible.
CLK	Input	The shift clock input pin for serial data transfer.
DI	Input	The data input pin for serial data transfer.
DO	Output	The data output pin for serial data transfer.
FOUT	Output	FOUT pin is 32.768 kHz clock output pin that output control is possible. (N-ch open drain) High impedance at the time of output off.
/INT	Output	Interrupt output (N-ch open drain)
TEST	—	* Used by the manufacturer for testing. (Do not connect externally.)
VDD	—	Connected to a positive power supply.
GND	—	Connected to a ground.

Terminal connection / External dimensions

(Unit:mm)

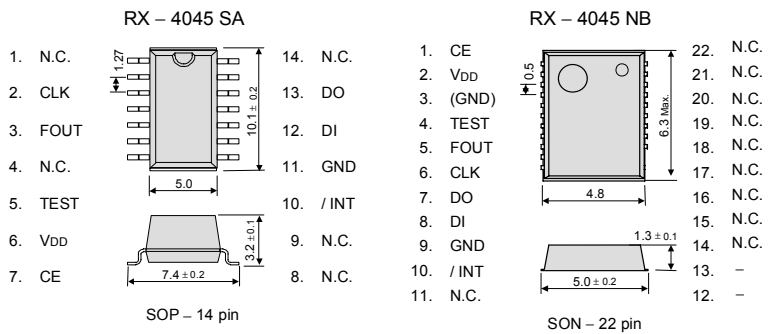

Metal may be exposed on the top or bottom of this product. This will not affect any quality, reliability or electrical spec.

Specifications (characteristics)

Recommended Operating Conditions

Item	Symbol	Condition	Min.	Typ.	Max.	Unit
Power voltage	VDD	—	1.7	3.0	5.5	V
Clock voltage	VCLK	—	1.15	3.0	5.5	V
Operating temperature	TOPR	—	-40	+25	+85	°C

Frequency characteristics

Item	Symbol	Condition	Rating	Unit
Frequency tolerance	$\Delta f / f$	$T_a = +25^\circ\text{C}$ $V_{DD} = 3.0\text{V}$	AA: 5 ± 5 *1) AC: 0 ± 5 *2)	$\times 10^{-6}$
Oscillation start-up time	tSTA	$T_a = +25^\circ\text{C}$ $V_{DD} = 2.0\text{V}$	1 Max.	s
Frequency / voltage characteristics	f / V	$T_a = +25^\circ\text{C}$ $V_{DD} = 2.0\text{V to } 5.5\text{V}$	± 1 Max.	$\times 10^{-6}$

*1) *2) Equivalent to 13 seconds of monthly deviation (excluding offset.)

DC characteristics

$T_a = -40^\circ\text{C to } +85^\circ\text{C}$

Item	Symbol	Condition	Min.	Typ.	Max.	Unit
Current Consumption	I _{BK}	CE = GND FOUT ; output OFF (Hi-Z)	VDD = 5 V	0.60	1.80	μA
			VDD = 3 V	0.48	1.20	
	I _{32k}	CE = GND FOUT ; 32.768 kHz output ON	VDD = 3 V	0.65	2.00	μA

Power supply detection voltage

$T_a = -30^\circ\text{C to } +70^\circ\text{C}$

Item	Symbol	Condition	Min.	Typ.	Max.	Unit
High-voltage mode	VDETH	VDD pin	1.90	2.10	2.30	V
Low-voltage mode	VDETL	VDD pin	1.15	1.30	1.45	V

Built-in SRAM

SERIAL-INTERFACE REAL TIME CLOCK MODULE

RX-4581 NB

Product number (please contact us)
RX-4581 NB : Q41458191000400

- Built in frequency adjusted 32.768 kHz crystal unit.
- Interface Type : Serial interface in 4 lines form.
- Operating voltage range : 1.6 V to 5.5 V
- Wide Timekeeper voltage range : 1.6 V to 5.5 V
- Low backup current : 0.4 μ A / 3 V (Typ.)
- Built-in SRAM : Built-in 128 bit (8 bit \times 16) RAM.
- 32.768kHz frequency output function : C-MOS output With Control Pin
- The various functions include full calendar, alarm, timer.
- Complies with EU RoHS directive

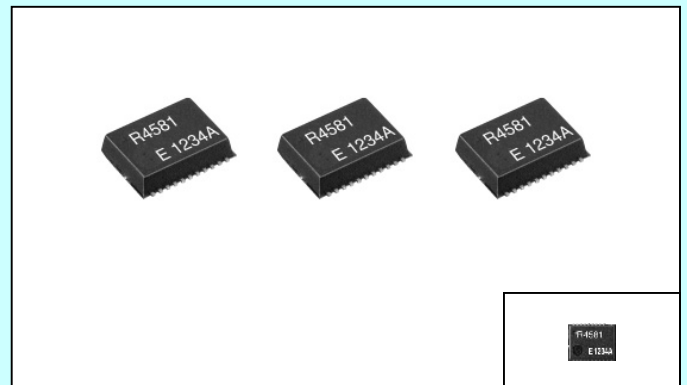

Actual size

* Refer to application manual for details.

<http://www.epsondevice.com>

■ Block diagram

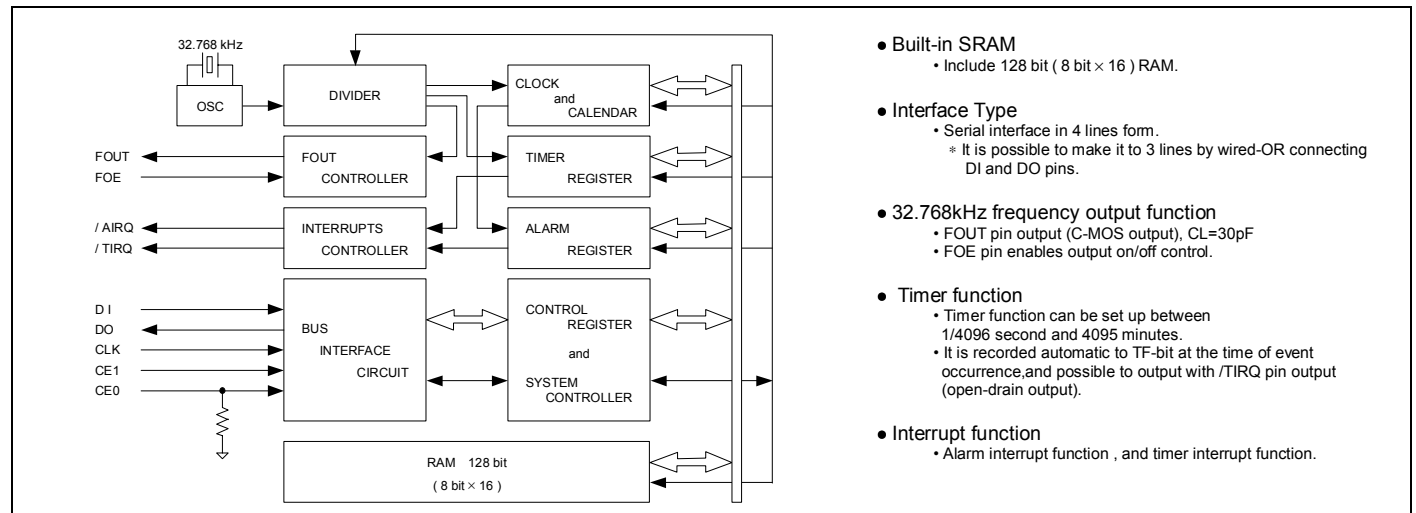

■ Overview

- Built-in SRAM
 - Include 128 bit (8 bit \times 16) RAM.
- Interface Type
 - Serial interface in 4 lines form.
 - * It is possible to make it to 3 lines by wired-OR connecting DI and DO pins.
- 32.768kHz frequency output function
 - FOUT pin output (C-MOS output), CL=30pF
 - FOE pin enables output on/off control.
- Timer function
 - Timer function can be set up between 1/4096 second and 4095 minutes.
 - It is recorded automatic to TF-bit at the time of event occurrence, and possible to output with /TIRQ pin output (open-drain output).
- Interrupt function
 - Alarm interrupt function , and timer interrupt function.

■ Pin Function

Signal Name	Input/Output	Function
CE0	Input	The chip enabled input pin 0. (It has a built -in pull-down resistance)
CE1	Input	The chip enabled input pin 1. (It does not have a built -in pull-down resistance)
CLK	Input	The shift clock input pin for serial data transfer.
DI	Input	The data input pin for serial data transfer.
DO	Output	The data output pin for serial data transfer.
FOUT	Output	This pin outputs the reference clock signal at 32.768 kHz (CMOS output). High impedance at the time of output off.
FOE	Input	The input pin for the FOUT output control.
/ AIRQ	Output	The open drain output pin for alarm and time update interrupts.
/ TIRQ	Output	The open drain output pin for timer interrupt.
VDD	—	Connected to a positive power supply.
GND	—	Connected to a ground.

■ Terminal connection / External dimensions (Unit:mm)

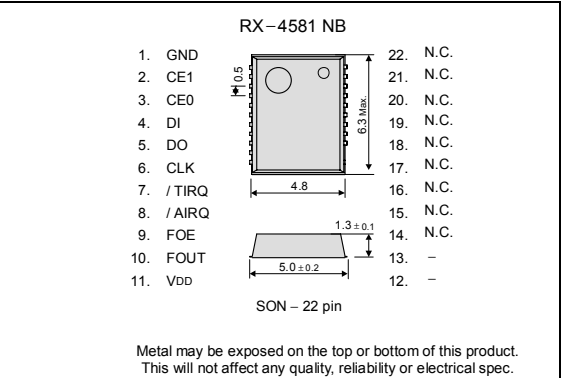

■ Specifications (characteristics)

■ Recommended Operating Conditions						
Item	Symbol	Condition	Min.	Typ.	Max.	Unit
Power voltage	VDD	—	1.6	3.0	5.5	V
Clock voltage	VCLK	—	1.6	3.0	5.5	V
Operating temperature	TOPR	—	-40	+25	+85	°C

■ Frequency characteristics				
Item	Symbol	Condition	Rating	Unit
Frequency tolerance	$\Delta f / f$	Ta = +25 °C VDD = 3.0 V	5 \pm 23 *	$\times 10^{-6}$
Oscillation start-up time	tSTA	Ta = +25 °C VDD = 3.0 V	3 Max.	s

* Please ask for tighter tolerance. (Equivalent to 1 minute of monthly deviation)

■ DC characteristics						
Ta = -40 °C to +85 °C						
Item	Symbol	Condition	Min.	Typ.	Max.	Unit
Current Consumption	IBK	CE0, CE1 = GND FOE = GND	VDD = 5 V	0.6	1.2	μ A
		FOUT ;output OFF (Hi - z)	VDD = 3 V	0.4	0.8	
	I32k	CE0, CE1 = GND FOE = VDD	VDD = 5 V	8.0	20.0	μ A
		FOUT ; 32.768 kHz output ON CL = 30 pF	VDD = 3 V	5.0	12.0	

Built-in EEPROM

SERIAL-INTERFACE REAL TIME CLOCK MODULE
RTC - 9701 JE

Product Number (please contact us)
RTC - 9701 JE : Q41970171000100

- Built in frequency adjusted 32.768 kHz crystal unit.
- Interface Type : Serial interface in 4 lines form.
- Operating voltage range : 2.7 V to 3.6 V
- Wide Timekeeper voltage range : 1.8 V to 5.5 V
- Include EEPROM : 4 kbit (256 × 16 bit)
- Various detection Functions : Ex.Power supply voltage monitoring function
- 32.768kHz frequency output function: C-MOS output With Control Pin
- The various functions include full calendar, alarm, timer.
- Complies with EU RoHS directive.

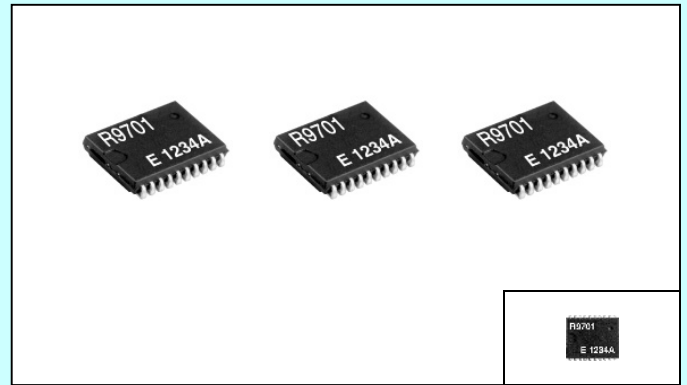

* Refer to application manual for details.

Actual size

<http://www.epsondevice.com>

■ **Block diagram**

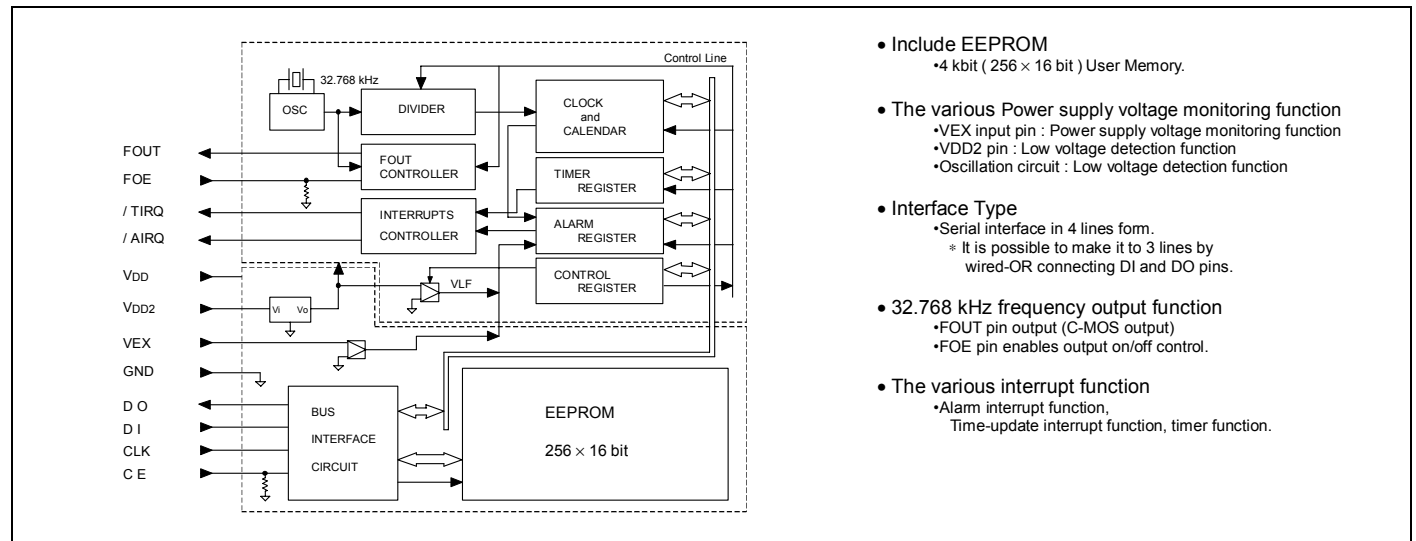

■ **Overview**

- Include EEPROM
 - 4 kbit (256 × 16 bit) User Memory.
- The various Power supply voltage monitoring function
 - VEX input pin : Power supply voltage monitoring function
 - VDD2 pin : Low voltage detection function
 - Oscillation circuit : Low voltage detection function
- Interface Type
 - Serial interface in 4 lines form.
 - * It is possible to make it to 3 lines by wired-OR connecting DI and DO pins.
- 32.768 kHz frequency output function
 - FOUT pin output (C-MOS output)
 - FOE pin enables output on/off control.
- The various interrupt function
 - Alarm interrupt function,
 - Time-update interrupt function, timer function.

■ **Pin Function**

Signal Name	Input / Output	Function
VDD	—	Connected to a positive power supply.
VDD2	—	RTC power. * Always supply the power irrespective of action situation to this terminal.
VEX	—	External voltage detection input pin
CE	Input	The chip enabled input pin. (built-in pull-down resistance)
CLK	Input	The shift clock input pin for serial data transfer.
DI	Input	The data input pin for serial data transfer.
DO	Output	The data output pin for serial data transfer.
FOUT	Output	This pin outputs the reference clock signal at 32.768 kHz (CMOS output). High impedance at the time of output off.
FOE	Input	The input pin for the FOUT output control.
/AIRQ	Output	Open drain output pin for alarm and time update interrupts.
/TIRQ	Output	Open drain output pin for timer interrupt.
GND	—	Connected to a ground.

■ **Terminal connection / External dimensions (Unit:mm)**

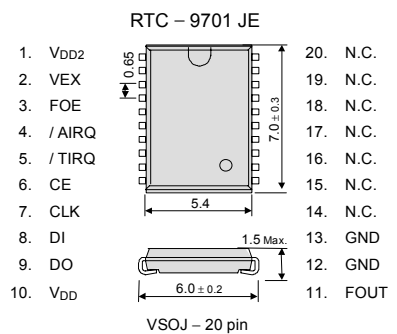

Metal may be exposed on the top or bottom of this product. This will not affect any quality, reliability or electrical spec

■ **Specifications (characteristics)**

* If not specifically indicated, VDD = 2.7 V to 3.6 V , VDD2 = 1.8 V to 5.5 V , Ta = -40 °C to +85 °C

■ **Recommended Operating Conditions**

Item	Symbol	Condition	Min.	Typ.	Max.	Unit
Power voltage	VDD	VDD pin	2.7	3.0	3.6	V
Clock voltage	VDD2	VDD2 pin	1.8	3.0	5.5	V
Analog voltage	VEX	VEX pin	1.4		5.5	V
Operating temperature	TOPR	—	-40	+25	+85	°C

■ **Frequency characteristics**

Item	Symbol	Condition	Rating	Unit
Frequency tolerance	$\Delta f / f$	Ta = +25 °C VDD = 3.0 V	5 ± 23 *	× 10 ⁻⁶

* Please ask for tighter tolerance. (Equivalent to 1 minute of monthly deviation)

■ **EEPROM Memory characteristics**

Item	Min.	Typ.	Max.	Unit
Memory contents	4 kbit (256 × 16 bit)			—
Program/Erase cycle	10 ⁵			times
Current consumption (write to EEPROM)		1	3	mA
Access time		5	10	ms
CLK dock cycle	VDD = 3.0 V ± 0.3 V	1000		ns
CLK dock cycle	VDD = 3.3 V ± 0.3 V	900		ns

■ **AC characteristics**

Item	Min.	Typ.	Max.	Unit
CLK dock cycle	500			ns

Built-in Temperature Sensor SERIAL-INTERFACE REAL TIME CLOCK MODULE RTC - 4701 JE / NB

Product Number (please contact us)

RTC - 4701 JE : Q41470171000200
RTC - 4701 NB : Q41470191000200

- Built-in 32.768 kHz quartz oscillator : Frequency adjusted for high accuracy. (5±23 × 10⁻⁶)
- Interface Type : Serial interface in 3 lines form.
- Operating voltage range : 1.6 V to 5.5 V
- Wide Timekeeper voltage range : 1.6 V to 5.5 V
- Built-in temperature sensor : Detects temperature.
Convert of output to analog voltage
- 32.768kHz frequency output function : C-MOS output With Control Pin
- Function of time and calendar, the various interrupt function etc.
- Complies with EU RoHS directive

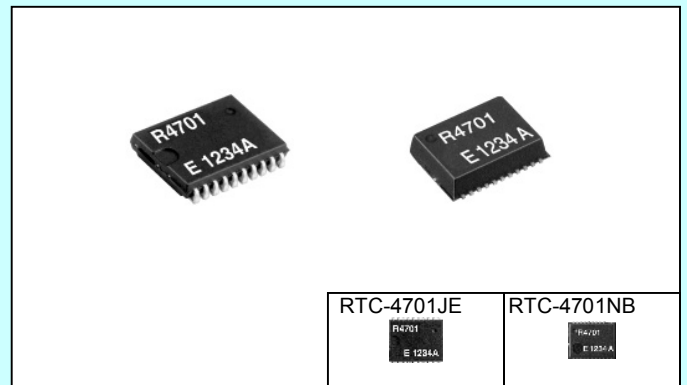

Actual size

* Refer to application manual for details.

<http://www.epsondevice.com>

Block diagram

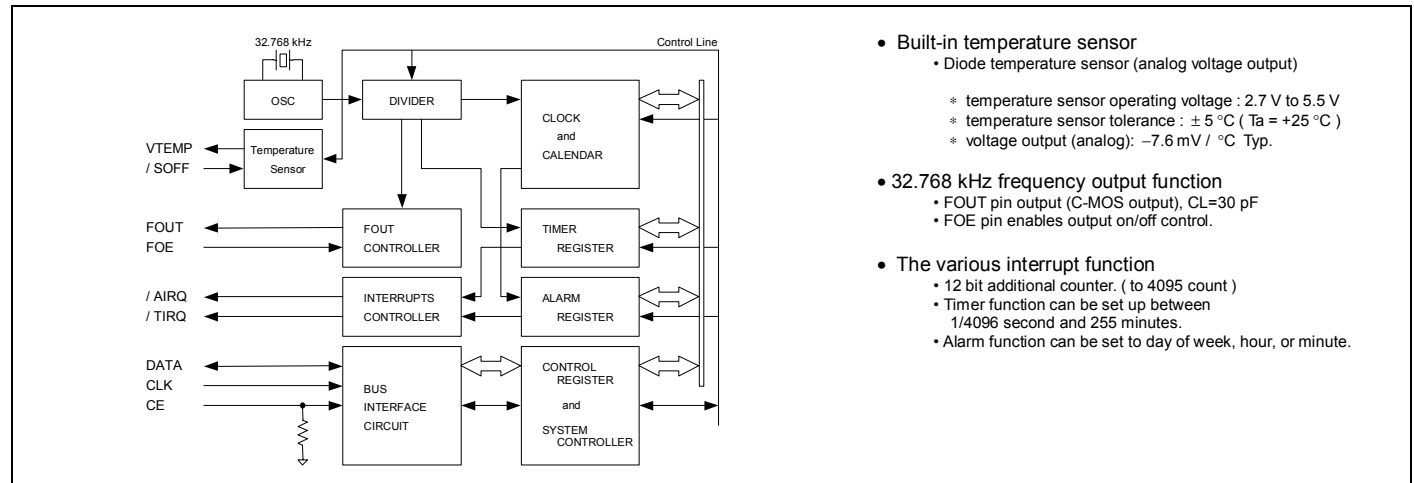

Overview

- Built-in temperature sensor
 - Diode temperature sensor (analog voltage output)
 - * temperature sensor operating voltage : 2.7 V to 5.5 V
 - * temperature sensor tolerance : ± 5 °C (Ta = +25 °C)
 - * voltage output (analog) : -7.6 mV / °C Typ.
- 32.768 kHz frequency output function
 - FOUT pin output (C-MOS output), CL=30 pF
 - FOE pin enables output on/off control.
- The various interrupt function
 - 12 bit additional counter. (to 4095 count)
 - Timer function can be set up between 1/4096 second and 255 minutes.
 - Alarm function can be set to day of week, hour, or minute.

Pin Function

Signal Name	Input / Output	Function						
CE	Input	The chip enabled input pin. (Built-in pull-down resistance)						
CLK	Input	The shift clock input pin for serial data transfer.						
DATA	Bi-directional	The data input / output pin for serial data transfer.						
FOUT	Output	<table border="1"> <thead> <tr> <th>FOE input</th> <th>FOUT output</th> </tr> </thead> <tbody> <tr> <td>HIGH</td> <td>32.768 kHz output * C-MOS output</td> </tr> <tr> <td>LOW</td> <td>output OFF * Hi - z</td> </tr> </tbody> </table>	FOE input	FOUT output	HIGH	32.768 kHz output * C-MOS output	LOW	output OFF * Hi - z
FOE input	FOUT output							
HIGH	32.768 kHz output * C-MOS output							
LOW	output OFF * Hi - z							
FOE	Input							
VTEMP	Output	The voltage output pin for the temperature sensor (analog).						
/SOFF	Input	The input pin for the temperature sensor control.						
/AIRQ	Output	Output 1 pin (N-ch open drain)						
/TIRQ	Output	Output 2 pin (N-ch open drain)						
VDD	—	Connected to a positive power supply.						
GND	—	Connected to a ground.						

Terminal connection / External dimensions

(Unit:mm)

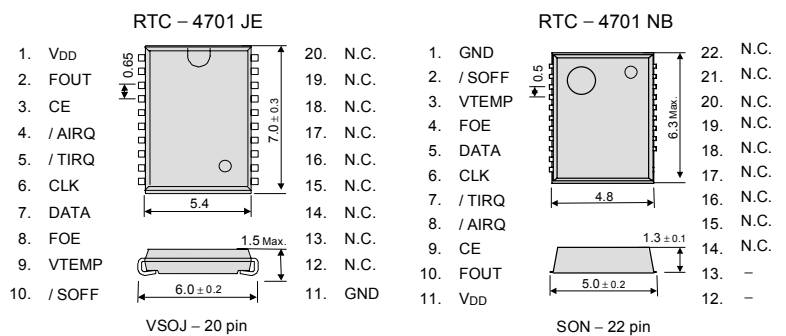

Metal may be exposed on the top or bottom of this product. This will not affect any quality, reliability or electrical spec.

Temperature sensor characteristics

* If not specifically indicated, GND = 0 V, VDD = 2.7 V to 5.5 V, Ta = -40 °C to +85 °C

Item	Symbol	Condition	Min.	Typ.	Max.	Unit
Temperature output voltage	VTEMP	VTEMP pin, Ta = +25 °C GND based output voltage		1.480		V
Output tolerance	TACR	Ta = +25 °C			± 5.0	°C
Temperature sensitivity	VSE	-40 °C ≤ Ta ≤ +85 °C	-7.1	-7.6	-8.1	mV / °C
Linearity	ΔNL	-40 °C ≤ Ta ≤ +85 °C			± 2.0	%
Temperature detection range	TSOP	ΔNL ≤ ± 2.0 %	-40		+ 85	°C
Output resistance	Ro	VTEMP pin, Ta = +25 °C GND standard and VDD standard		1.0	3.0	kΩ

* Temperature sensitivity $VSE = (V(+85\text{ }^{\circ}\text{C}) - V(-40\text{ }^{\circ}\text{C})) / 125 \text{ [mV / }^{\circ}\text{C]}$
 * Linearity $\Delta NL = \frac{a}{b} \times 100 \text{ [%]}$
 * Output resistance (Ro) $Ro = \frac{\Delta V}{\Delta I} \text{ [}\Omega\text{]}$

a : Maximum deviation between the measured value of VTEMP and approximate straight line.
 b : Difference between the measured values at -40 °C and +85 °C.

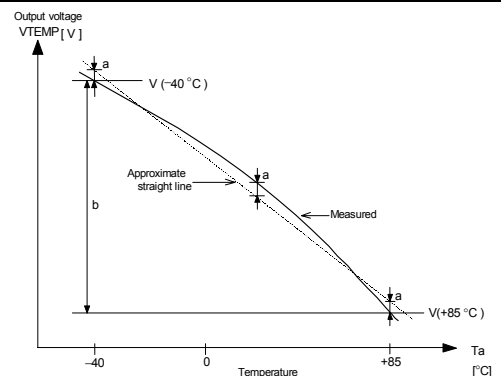

SERIAL-INTERFACE REAL TIME CLOCK MODULE

RTC - 4574 SA / JE / NB

Product Number (please contact us)

- RTC - 4574 SA : Q41457451000200
- RTC - 4574 JE : Q41457471000100
- RTC - 4574 NB : Q41457491xxxx00

- Built in frequency adjusted 32.768 kHz crystal unit.
- Interface Type : Serial interface in 3 lines form.
- Operating voltage range : 1.6 V to 5.5 V
- Wide Timekeeper voltage range : 1.6 V to 5.5 V
- Low backup current : 0.5 μ A / 3 V (Typ.)
- 32.768kHz frequency output function: C-MOS output With Control Pin
- The various functions include full calendar, alarm, timer.
- Complies with EU RoHS directive.

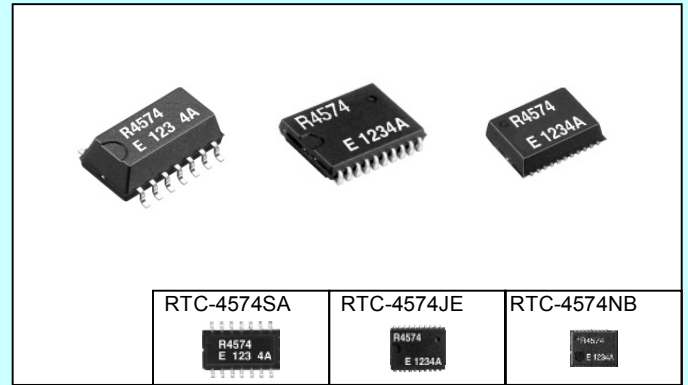

Actual size

* Refer to application manual for details.

<http://www.epsondevice.com>

Block diagram

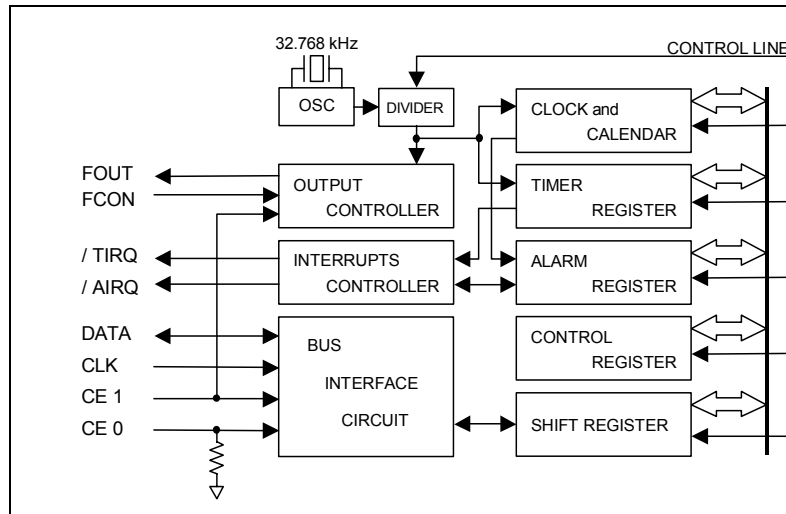

Overview

- 32.768 kHz frequency output function
 - FOUT pin output (C-MOS output), CL=30 pF
 - Output frequency selectable from 1/30 Hz to 32.768 kHz(32 Values)
- Timer function
 - Timer function can be set upbetween 1/4096 second and 255 minutes.
 - It is recorded automatic to TF-bit at the time of event occurrence, and possible to output with /TIRQ pin output (open-drain output).
 - Selectable one time mode or repeat mode.
- Alarm function
 - Alarm function can be set to any combination of day of week, hour, or minute.
 - It is recorded automatic to AF-bit at the time of event occurrence, and possible to output with /AIRQ pin output (open-drain output).

* Functions are compatible with RX - 4574 LC.

Terminal connection / External dimensions

(Unit:mm)

RTC - 4574 SA		RTC - 4574 JE		RTC - 4574 NB	
1. GND	14. FCON	1. V _{DD}	20. N.C.	1. GND	22. N.C.
2. FOUT	13. CE1	2. FOUT	19. N.C.	2. FCON	21. N.C.
3. N.C.	12. DATA	3. CE0	18. N.C.	3. N.C.	20. N.C.
4. N.C.	11. CLK	4. /AIRQ	17. N.C.	4. CE1	19. N.C.
5. N.C.	10. /TIRQ	5. /TIRQ	16. N.C.	5. DATA	18. N.C.
6. N.C.	9. /AIRQ	6. CLK	15. N.C.	6. CLK	17. N.C.
7. V _{DD}	8. CE0	7. DATA	14. N.C.	7. /TIRQ	16. N.C.
		8. CE1	13. N.C.	8. /AIRQ	15. N.C.
		9. FCON	12. N.C.	9. CE0	14. N.C.
		10. GND	11. N.C.	10. FOUT	13. -
				11. V _{DD}	12. -

Metal may be exposed on the top or bottom of this product. This will not affect any quality, reliability or electrical spec.

Specifications (characteristics)

Recommended Operating Conditions						
Item	Symbol	Condition	Min.	Typ.	Max.	Unit
Power voltage	V _{DD}	—	1.6	3.0	5.5	V
Clock voltage	V _{CLK}	—	1.6	3.0	5.5	V
Operating temperature	T _{OPR}	—	-40	+25	+85	°C

Frequency characteristics				
Item	Symbol	Condition	Rating	Unit
Frequency tolerance	$\Delta f / f$	T _a = +25 °C V _{DD} = 3.0 V	5 ± 23 *	× 10 ⁻⁶
Oscillation start-up time	t _{STA}	T _a = +25 °C V _{DD} = 1.6 V	3 Max.	s

DC characteristics						
T _a = -40 °C to +85 °C						
Item	Symbol	Condition	Min.	Typ.	Max.	Unit
Current Consumption	I _{BK}	CE0, CE1 = GND FOUT ; output OFF (Hi - z)	V _{DD} = 5 V	1.0	2.0	μ A
			V _{DD} = 3 V	0.5	1.0	
	I _{32k}	CE0 = GND CE1 = V _{DD} FOUT ; 32.768 kHz output ON CL = 30 pF	V _{DD} = 5 V	8.0	20.0	μ A
			V _{DD} = 3 V	5.0	12.0	

* Please ask for tighter tolerance. (Equivalent to 1 minute of monthly deviation)

Small size thin model package

SERIAL-INTERFACE REAL TIME CLOCK MODULE

RX - 4574 LC

Product Number (please contact us)

RX - 4574 LC : Q414574C0xxxx00

- Built in frequency adjusted 32.768 kHz crystal unit.
- Interface Type : Serial interface in 3 lines form.
- Operating voltage range : 1.6 V to 5.5 V
- Wide Timekeeper voltage range : 1.3 V to 5.5 V
- Low backup current : 0.35 μ A / 3 V (Typ.)
- 32.768kHz frequency output function : C-MOS output With Control Pin
- The various functions include full calendar, alarm, timer.
- Complies with EU RoHS directive



Actual size

* Refer to application manual for details.

<http://www.epsondevice.com>

■ Block diagram

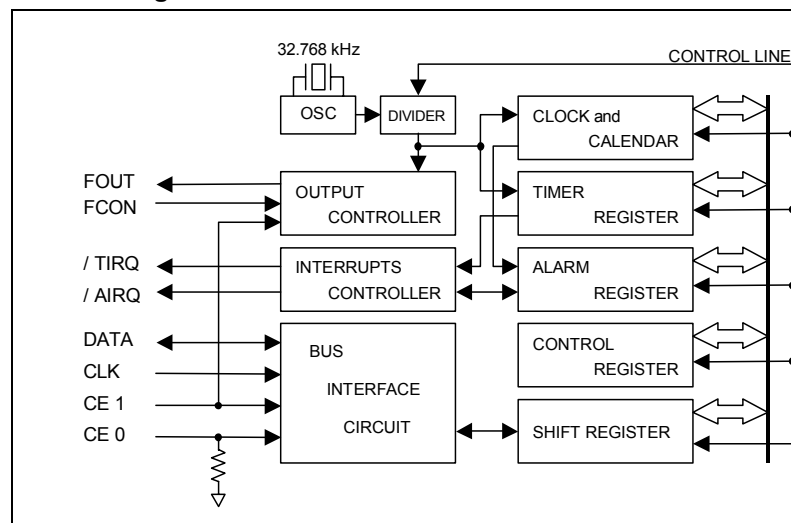

■ Overview

- 32.768 kHz frequency output function
 - FOUT pin output (C-MOS output), CL=30 pF
 - Output frequency is selectable from 1/30 Hz to 32.768 kHz(32 Values)
- Timer function
 - Timer function which can be set up between 1/4096 second and 255 minutes.
 - It is recorded automatic to TF-bit at the time of event occurrence, and possible to output with /TIRQ pin output (open-drain output).
 - Selectable one time mode or repeat mode.
- Alarm function
 - Alarm function can be set to any combination of day of week, hour, or minute.
 - It is recorded automatic to AF-bit at the time of event occurrence, and possible to output with /AIRQ pin output (open-drain output).

* Functions are compatible with RTC-4574 SA/ JE/ NB.

■ Pin Function

Signal Name	Input / Output	Function
CE0	Input	The chip enabled input pin 0. When both CE0 and CE1 pins are at the "H" level, access to this Real time clock module becomes possible.
CE1	Input	The chip enabled input pin 1. When the CE1 pin is at the HIGH level, the FOUT pin is in the output state.
CLK	Input	The shift clock input pin for serial data transfer.
DATA	Bi-directional	The data input / output pin for serial data transfer.
FOUT	Output	This pin outputs the reference clock signal at 32.768 kHz (CMOS output). High impedance at the time of output off.
FCON	Input	The input pin for the FOUT output control.
/AIRQ	Output	The open drain output pin for alarm and time update interrupts.
/TIRQ	Output	The open drain output pin for timer interrupt.
VDD	—	Connected to a positive power supply.
GND	—	Connected to a ground.

■ Terminal connection / External dimensions (Unit:mm)

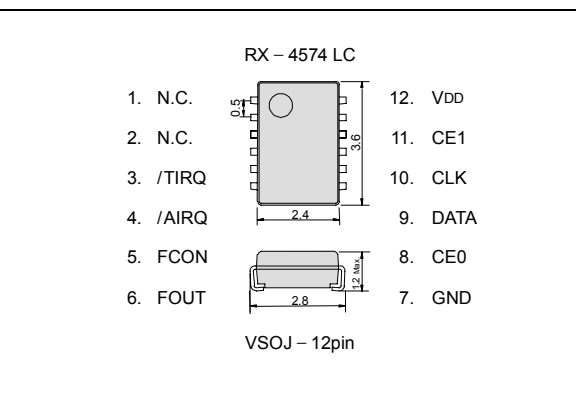

■ Specifications (characteristics)

Recommended Operating Conditions						
Item	Symbol	Condition	Min.	Typ.	Max.	Unit
Power voltage	VDD	—	1.6	3.0	5.5	V
Clock voltage	VCLK	—	1.3	3.0	5.5	V
Operating temperature	T _{OPR}	—	-40	+25	+85	°C

Frequency characteristics				
Item	Symbol	Condition	Rating	Unit
Frequency tolerance	$\Delta f / f$	T _a = +25 °C VDD = 3.0 V	5 ± 23 *	× 10 ⁻⁶
Oscillation Start-up time	t _{STA}	T _a = +25 °C VDD = 1.6 V	1 Max.	s
		T _a = -40 °C to +85 °C VDD = 1.6 V	3 Max.	s

*Equivalent to 1 minute of monthly deviation

DC characteristics						
Item	Symbol	Condition	Min.	Typ.	Max.	Unit
Current Consumption	I _{BK}	CE0, CE1 = GND FOUT ;output OFF (Hi - z)	VDD = 5 V	0.45	0.9	μ A
			VDD = 3 V	0.35	0.7	
	I _{32k}	CE0 = GND CE1 = VDD FOUT ; 32.768 kHz output ON CL = 30 pF	VDD = 5 V	8.0	20.0	μ A
			VDD = 3 V	5.0	12.0	

T_a = -40 °C to +85 °C

FOR AUTOMOTIVE SERIAL-INTERFACE REAL TIME CLOCK MODULE RA - 4574 SA

Product Number (please contact us)
RTC - 4574 SA : Q41A47451xxxx00

- Built in frequency adjusted 32.768 kHz crystal unit.
- Interface Type : Serial interface in 3 lines form.
- Operating voltage range : 1.6 V to 5.5 V
- Wide Timekeeper voltage range : 1.6 V to 5.5 V
- Low backup current : 0.5 μ A / 3 V (Typ.)
- 32.768kHz frequency output function : C-MOS output With Control Pin
- The various functions include full calendar, alarm, timer.
- Complies with EU RoHS directive.

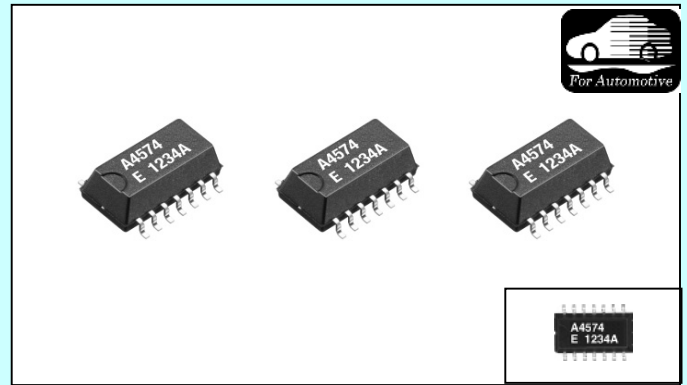

Actual size

* Refer to application manual for details.

<http://www.epsondevice.com>

■ Block diagram

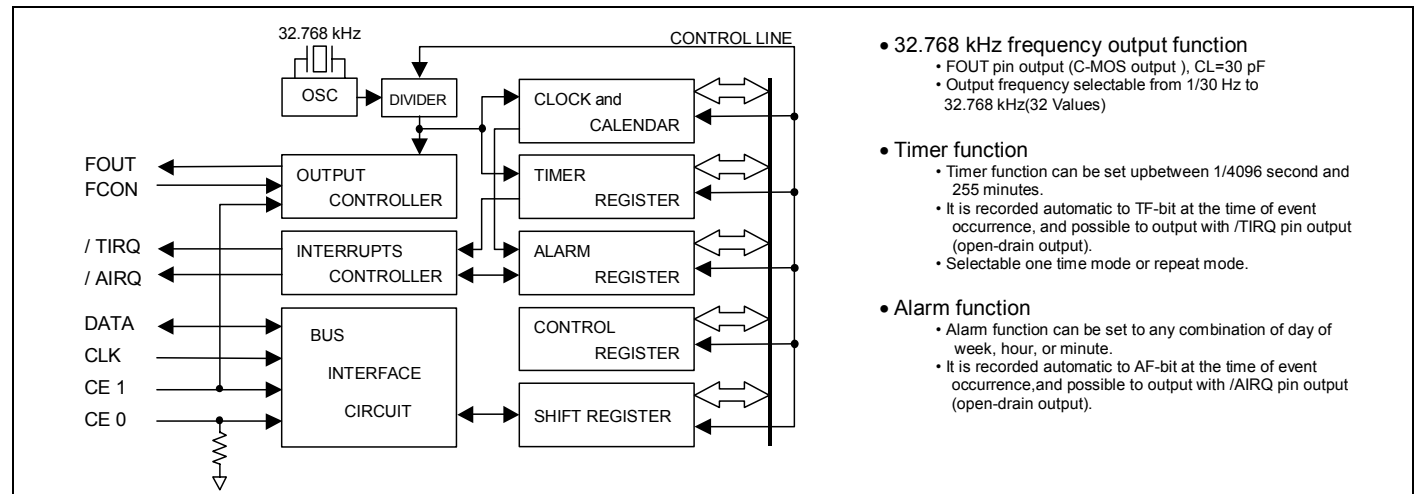

■ Overview

- 32.768 kHz frequency output function
 - FOUT pin output (C-MOS output), CL=30 pF
 - Output frequency selectable from 1/30 Hz to 32.768 kHz(32 Values)
- Timer function
 - Timer function can be set up between 1/4096 second and 255 minutes.
 - It is recorded automatic to TF-bit at the time of event occurrence, and possible to output with /TIRQ pin output (open-drain output).
 - Selectable one time mode or repeat mode.
- Alarm function
 - Alarm function can be set to any combination of day of week, hour, or minute.
 - It is recorded automatic to AF-bit at the time of event occurrence, and possible to output with /AIRQ pin output (open-drain output).

■ Pin Function

Signal Name	Input / Output	Function
CE0	Input	The chip enabled input pin 0. When both CE0 and CE1 pins are at the "H" level, access to this Real time clock module becomes possible.
CE1	Input	The chip enabled input pin 1. When the CE1 pin is at the HIGH level, the FOUT pin is in the output state.
CLK	Input	The shift clock input pin for serial data transfer.
DATA	Bi-directional	The data input / output pin for serial data transfer.
FOUT	Output	This pin outputs the reference clock signal at 32.768 kHz (CMOS output). High impedance at the time of output off.
FCON	Input	The input pin for the FOUT output control.
/AIRQ	Output	The open drain output pin for alarm and time update interrupts.
/TIRQ	Output	The open drain output pin for timer interrupt.
VDD	—	Connected to a positive power supply.
GND	—	Connected to a ground.

■ Terminal connection / External dimensions (Unit:mm)

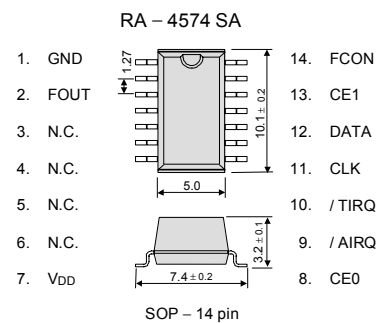

Metal may be exposed on the top or bottom of this product. This will not affect any quality, reliability or electrical spec.

■ Specifications (characteristics)

■ Recommended Operating Conditions

Item	Symbol	Condition	Min.	Typ.	Max.	Unit
Power voltage	VDD	—	1.6	3.0	5.5	V
Clock voltage	VCLK	—	1.6	3.0	5.5	V
Operating temperature	T _{OPR}	—	-40	+25	+85	°C

■ Frequency characteristics

Item	Symbol	Condition	Rating	Unit
Frequency tolerance	$\Delta f/f$	T _a = +25 °C VDD = 3.0 V	5 ± 23 *	× 10 ⁻⁶
Oscillation start-up time	t _{STA}	T _a = +25 °C VDD = 1.6 V	3 Max.	s

* Please ask for tighter tolerance.(Equivalent to 1 minute of monthly deviation)

■ DC characteristics

T_a = -40 °C to +85 °C

Item	Symbol	Condition	Min.	Typ.	Max.	Unit
Current Consumption	I _{BK}	CE0, CE1 = GND FOUT ; Output OFF (Hi - z)	VDD = 5 V	1.0	2.0	μ A
			VDD = 3 V	0.5	1.0	
	I _{32k}	CE0 = GND CE1 = VDD FOUT ; 32.768 kHz output ON CL = 30 pF	VDD = 5 V	8.0	20.0	μ A
			VDD = 3 V	5.0	12.0	

Simple Function

SERIAL-INTERFACE REAL TIME CLOCK MODULE

RTC - 4543 SA/SB

Product Number (please contact us)

- RTC - 4543 SA : Q41454351000200
- RTC - 4543 SB : Q41454361000200

- Built in frequency adjusted 32.768 kHz crystal unit.
- Interface type : Serial-interface
- Operating voltage range : 2.5 V to 5.5 V
- Wide Timekeeper voltage range : 1.4 V to 5.5 V
- 32.768kHz frequency output function : C-MOS output With Control Pin
- The various functions include full calendar, timer, and low voltage detection.
- Complies with EU RoHS directive

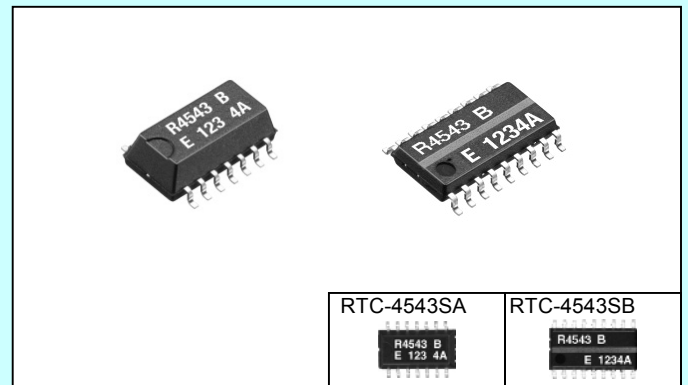

Actual size

* Refer to application manual for details.

<http://www.epsondevice.com>

Block diagram

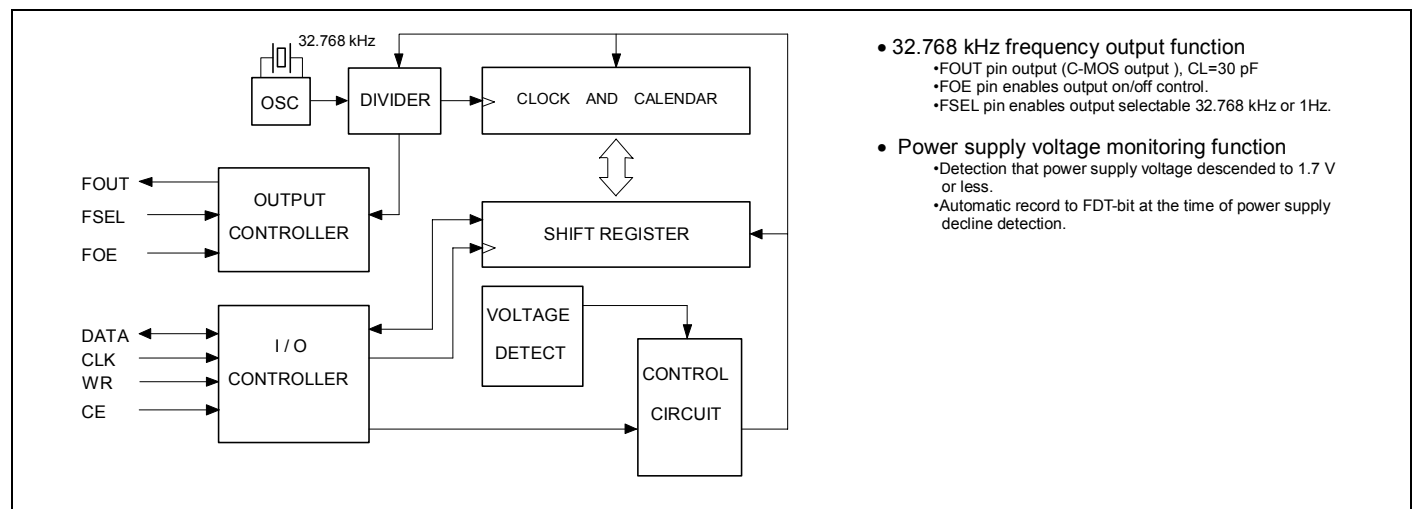

Overview

- 32.768 kHz frequency output function
 - FOUT pin output (C-MOS output), CL=30 pF
 - FOE pin enables output on/off control.
 - FSEL pin enables output selectable 32.768 kHz or 1Hz.
- Power supply voltage monitoring function
 - Detection that power supply voltage descended to 1.7 V or less.
 - Automatic record to FDT-bit at the time of power supply decline detection.

Pin Function

Signal Name	Input / Output	Function
CE	Input	The chip enabled input pin. At the HIGH level, access becomes possible.
CLK	Input	The shift clock input pin for serial data transfer.
WR	Input	DATA pin input / output switching pin.
DATA	Bi-directional	The data input / output pin for serial data transfer.
FOUT	Output	32.768 kHz or 1Hz clock output pin (C-MOS output). High impedance at output off.
FOE	Input	The input pin for the FOUT output control.
FSEL	Input	Select the frequency that is output from the FOUT pin.
VDD	—	Connected to a positive power supply.
GND	—	Connected to a ground.

Terminal connection / External dimensions

(Unit:mm)

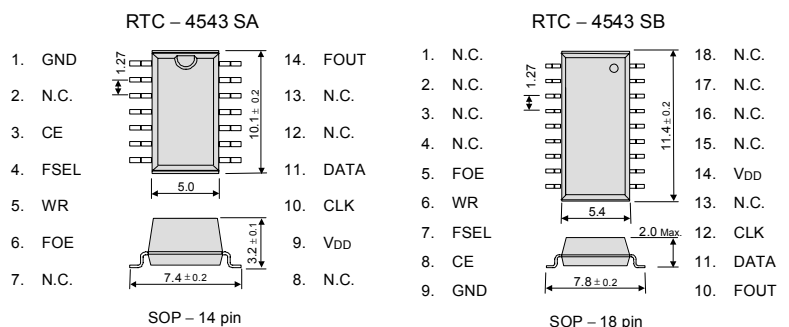

Metal may be exposed on the top or bottom of this product. This will not affect any quality, reliability or electrical spec.

Specifications (characteristics)

Recommended Operating Conditions

Item	Symbol	Condition	Min.	Typ.	Max.	Unit
Power voltage	VDD	—	2.5	5.0	5.5	V
Clock voltage	VCLK	—	1.4	5.0	5.5	V
Operating temperature	TOPR	—	-40	+25	+85	°C

Frequency characteristics

Item	Symbol	Condition	Rating	Unit
Frequency tolerance	$\Delta f/f$	Ta = +25 °C VDD = 5.0 V	5 ± 23*	× 10 ⁻⁶
Oscillation start-up time	t _{STA}	Ta = +25 °C VDD = 2.5 V	3 Max.	s

* Please ask for tighter tolerance.(Equivalent to 1 minute of monthly deviation)

DC characteristics

Ta = -40 °C to +85 °C

Item	Symbol	Condition	Min.	Typ.	Max.	Unit
Current Consumption	IBK	CE = GND FOE = GND FOUT ;output OFF (Hi-z)	VDD = 5 V	1.5	3.0	μA
			VDD = 3 V	1.0	2.0	
			VDD = 2 V	0.5	1.0	

Supply Voltage Detection Characteristic

Ta = -40 °C to +85 °C

Item	Symbol	Condition	Min.	Typ.	Max.	Unit
Power supply detection voltage	VDT	VDD pin	1.4	1.7	2.0	V

High-Stability

I²C-Bus INTERFACE REAL TIME CLOCK MODULE

RX - 8025 SA / NB

Product number (please contact us)

RX - 8025 SA : Q41802551xxxx00
 RX - 8025 NB : Q41802591xxxx00

- Built-in 32.768 kHz quartz oscillator : Frequency adjusted for high accuracy ($\pm 5 \times 10^{-6}$ / Ta = +25 °C)
- Interface Type : I²C-Bus Interface (400 kHz)
- Operating voltage range : 1.70 V to 5.5 V
- Wide Timekeeper voltage range : 1.15 V to 5.5 V
- Various detection Functions : Ex. Oscillation stop detection function
- Low backup current : 0.48 μ A / 3 V (Typ.)
- 32.768kHz frequency output function : C-MOS output With Control Pin
- The various functions include full calendar, alarm, timer.
- Complies with EU RoHS directive

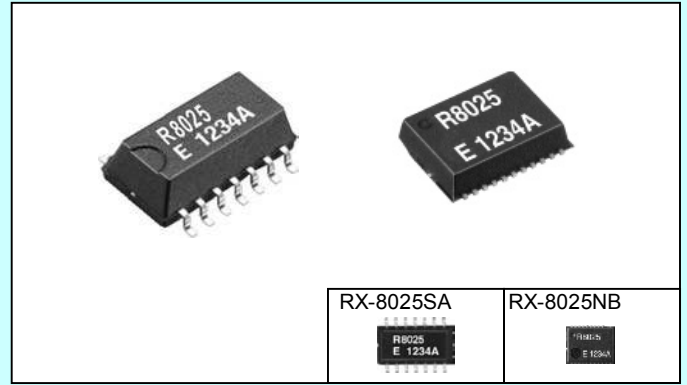

* Refer to application manual for details.

Actual size

*The I²C-Bus is a trademark of Philips Electronics N.V.

<http://www.epsondevice.com>

■ Block diagram

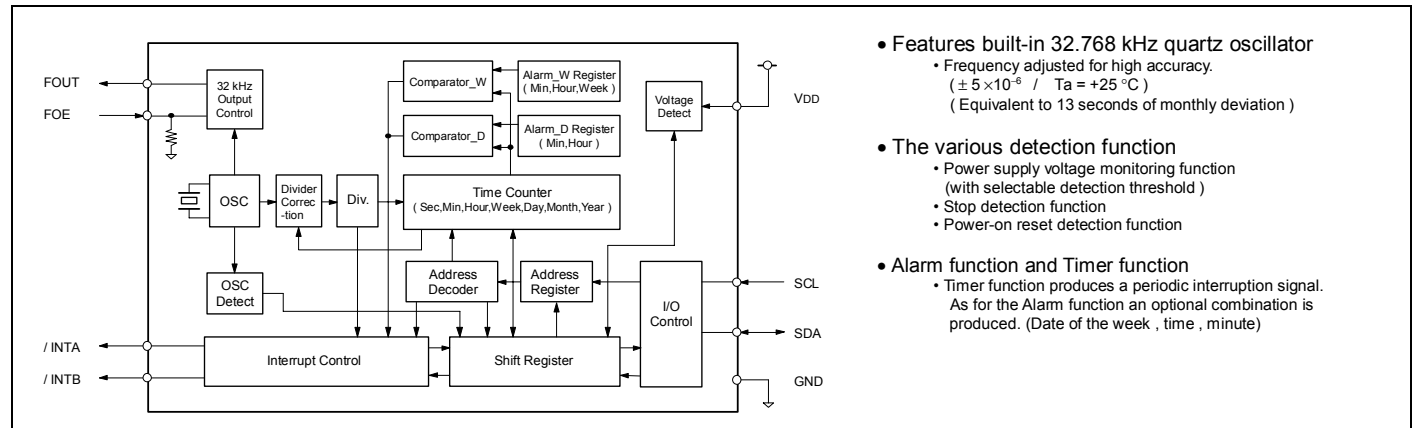

■ Overview

- Features built-in 32.768 kHz quartz oscillator
 - Frequency adjusted for high accuracy. ($\pm 5 \times 10^{-6}$ / Ta = +25 °C) (Equivalent to 13 seconds of monthly deviation)
- The various detection function
 - Power supply voltage monitoring function (with selectable detection threshold)
 - Stop detection function
 - Power-on reset detection function
- Alarm function and Timer function
 - Timer function produces a periodic interruption signal. As for the Alarm function an optional combination is produced. (Date of the week, time, minute)

■ Pin Function

Signal Name	Input / output	Function																						
SCL	Input	Serial clock input pin																						
SDA	Bi-directional	Data input and output pin																						
FOUT	Output	FOUT pin is 32.768 kHz clock output pin (C-MOS) that output control is possible.																						
FOE	Input	<table border="1"> <thead> <tr> <th>FOE input</th> <th>/CLEN1 bit</th> <th>/CLEN2 bit</th> <th>FOUT output</th> </tr> </thead> <tbody> <tr> <td>L</td> <td>X</td> <td>X</td> <td>OFF (LOW)</td> </tr> <tr> <td rowspan="3">H</td> <td>0</td> <td>0</td> <td>32.768 kHz</td> </tr> <tr> <td>0</td> <td>1</td> <td>32.768 kHz</td> </tr> <tr> <td>1</td> <td>0</td> <td>32.768 kHz</td> </tr> <tr> <td>1</td> <td>1</td> <td>0</td> <td>OFF(LOW)</td> </tr> </tbody> </table>	FOE input	/CLEN1 bit	/CLEN2 bit	FOUT output	L	X	X	OFF (LOW)	H	0	0	32.768 kHz	0	1	32.768 kHz	1	0	32.768 kHz	1	1	0	OFF(LOW)
FOE input	/CLEN1 bit	/CLEN2 bit	FOUT output																					
L	X	X	OFF (LOW)																					
H	0	0	32.768 kHz																					
	0	1	32.768 kHz																					
	1	0	32.768 kHz																					
1	1	0	OFF(LOW)																					
/INTA	Output	Interrupt output A pin (N-ch open drain)																						
/INTB	Output	Interrupt output B pin (N-ch open drain)																						
TEST	—	* Used by the manufacture for testing. (Do not connect externally.)																						
VDD	—	Connected to a positive power supply.																						
GND	—	Connected to a ground.																						

■ Terminal connection / External dimensions

(Unit:mm)

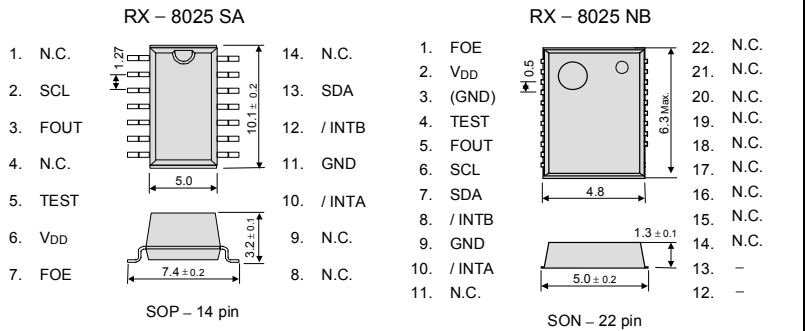

Metal may be exposed on the top or bottom of this product. This will not affect any quality, reliability or electrical spec.

■ Specifications (characteristics)

■ Recommended Operating Conditions						
Item	Symbol	Condition	Min.	Typ.	Max.	Unit
Power voltage	VDD	—	1.7	3.0	5.5	V
Clock voltage	VCLK	—	1.15	3.0	5.5	V
Operating temperature	TOPR	—	-40	+25	+85	°C

■ Frequency characteristics				
Item	Symbol	Condition	Range	Unit
Frequency tolerance	$\Delta f/f$	Ta = +25 °C VDD = 3.0 V	AA: 5 ± 5 ⁺¹⁾ AC: 0 ± 5 ⁺²⁾	$\times 10^{-6}$
Oscillation start-up time	t _{STA}	Ta = +25 °C VDD = 2.0 V	1 Max.	s
Frequency voltage characteristics	f/V	Ta = +25 °C VDD = 2.0 V to 5.5 V	± 1 Max.	$\times 10^{-6}$

*1) *2) Equivalent to 13 seconds of monthly deviation (excluding offset).

■ DC characteristics						
Item	Symbol	Condition	Min.	Typ.	Max.	Unit
Current Consumption	I _{BK}	f _{SCL} = 0Hz FOE = GND FOUT ; output OFF(LOW)	VDD = 5 V	0.60	1.80	μ A
			VDD = 3 V	0.48	1.20	
	I _{32k}	f _{SCL} = 0Hz VDD, FOE = 5.5 V FOUT ; output ON (Output=OPEN; CL = 0 pF)	VDD = 5.5 V	3.0	6.5	μ A

■ Power supply detection voltage						
Item	Symbol	Condition	Min.	Typ.	Max.	Unit
High-voltage mode	VDETH	VDD pin	1.90	2.10	2.30	V
Low-voltage mode	VDETL	VDD pin	1.15	1.30	1.45	V

Low current consumption

I²C-Bus INTERFACE REAL TIME CLOCK MODULE
RTC - 8564 JE / NB

Product Number (please contact us)

RTC - 8564 JE : Q41856471000100

RTC - 8564 NB : Q41856491000200

- Built in frequency adjusted 32.768 kHz crystal unit.
- Interface Type : I²C-Bus Interface (400 kHz)
- Operating voltage range : 1.8 V to 5.5 V
- Timekeeper voltage range : 1.0 V to 5.5 V / -20 °C to +70 °C
- Low backup current : 275 nA / 3.0 V(Typ.)
- 32.768kHz frequency output function : C-MOS output With Control Pin
- The various functions include full calendar, alarm, timer, and power supply voltage monitoring function
- Complies with EU RoHS directive



* Refer to application manual for details.

Actual size

* The I²C-Bus is a trademark of Philips Electronics N.V.

<http://www.epsondevice.com>

■ Block diagram

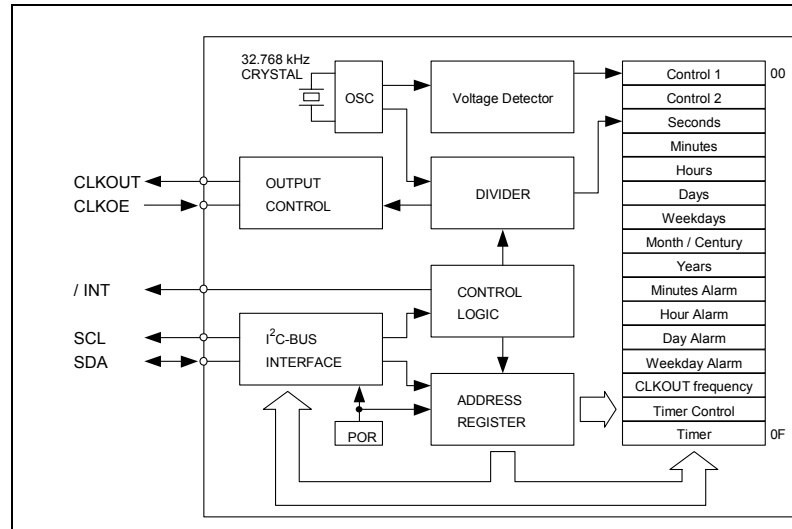

■ Overview

- Interface Type
 - I²C hi-speed bus specifications. (400 kHz)
 - * I²C-Bus slave address : read A3h and write A2h
- Low Timekeeper voltage range
 - 1.0 V to 5.5 V / Ta = -20 °C to +70 °C
 - 1.1 V to 5.5 V / Ta = -40 °C to +85 °C
- 32.768 kHz frequency output function
 - CLKOUT pin output (C-MOS output), CL=30 pF
 - CLKOE pin enables output on/off control.
 - Output selectable
 - <32.768 kHz, 1024 Hz, 32 Hz, 1 Hz>
- The various interrupt function
 - Timer function can be set up between 1/4096 second and 255 minutes.
 - Alarm function can be set to any combination of day of week, hour, or minute.

* Functions are compatible with RX-8564 LC series.

■ Pin Function

Signal Name	Input/Output	Function															
SCL	Input	Serial clock input pin.															
SDA	Bi-directional	Data input and output pin.															
CLKOUT	Output	FOUT pin is 32.768 kHz clock output pin (C-MOS) that output control is possible. CLKOE pin control the frequency output from CLKOUT pin with FE-bit etc.															
CLKOE	Input	<table border="1"> <thead> <tr> <th>CLKOE pin input</th> <th>FE bit</th> <th>CLKOUT pin output</th> </tr> </thead> <tbody> <tr> <td>HIGH</td> <td>1</td> <td>Output (C-MOS)</td> </tr> <tr> <td></td> <td>0</td> <td>OFF (LOW)</td> </tr> <tr> <td>LOW</td> <td>1</td> <td>OFF (LOW)</td> </tr> <tr> <td></td> <td>0</td> <td>OFF (LOW)</td> </tr> </tbody> </table>	CLKOE pin input	FE bit	CLKOUT pin output	HIGH	1	Output (C-MOS)		0	OFF (LOW)	LOW	1	OFF (LOW)		0	OFF (LOW)
CLKOE pin input	FE bit	CLKOUT pin output															
HIGH	1	Output (C-MOS)															
	0	OFF (LOW)															
LOW	1	OFF (LOW)															
	0	OFF (LOW)															
/INT	Output	Interrupt output (N-ch open drain)															
VDD	—	Connected to a positive power supply.															
GND	—	Connected to a ground.															

■ Terminal connection / External dimensions

(Unit:mm)

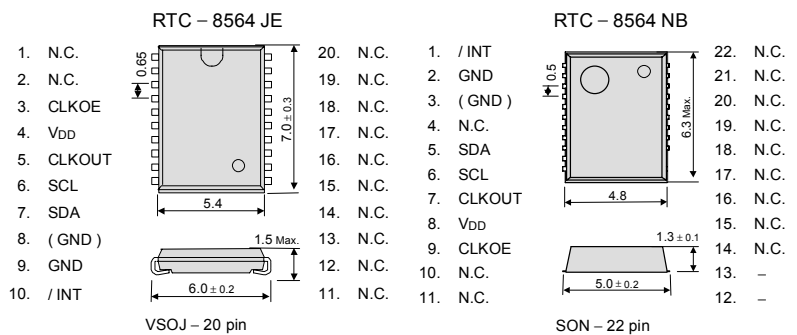

Metal may be exposed on the top or bottom of this product. This will not affect any quality , reliability or electrical spec.

■ Specifications (characteristics)

■ Recommended Operating Conditions

Item	Symbol	Condition	Min.	Typ.	Max.	Unit
Power voltage	VDD	—	1.8	3.0	5.5	V
Clock voltage	VCLK	—	VLOW	3.0	5.5	V
Operating temperature	TOPR	—	-40	+25	+85	°C

■ Low voltage detection

Item	Symbol	Condition	Typ.	Max.	Unit
Low voltage detection	VLOW	Ta = -20 °C ~ +70 °C	0.9	1.0	V
		Ta = -40 °C ~ +85 °C	0.9	1.1	V

■ Frequency characteristics

Item	Symbol	Condition	Rating	Unit
Frequency tolerance	Δ f / f	Ta = +25 °C VDD = 3.0 V	5 ± 23 *	× 10 ⁻⁶

* Equivalent to 1 minute of monthly deviation

■ DC characteristics

Ta = -40 °C to +85 °C

Item	Symbol	Condition	Min.	Typ.	Max.	Unit
Current Consumption	I _{BK}	fSCL = 0 Hz CLKOE = GND	VDD = 5 V	330	800	nA
		CLKOUT ; output OFF (LOW)	VDD = 3 V	275	700	
	I _{S2K}	fSCL = 0 Hz CLKOE = VDD	VDD = 5 V	2.5	3.4	μA
		CLKOUT ; 32.768 kHz output ON (Output=OPEN ; CL = 0 pF)	VDD = 3 V	1.5	2.2	

Low power consumption / Small size thin model package

I²C-Bus INTERFACE REAL TIME CLOCK MODULE

RX - 8564 LC

Product Number (please contact us)
RX - 8564 LC : Q418564C0xxxx00

- Built in frequency adjusted 32.768 kHz crystal unit.
- Interface Type : I²C-Bus Interface (400 kHz)
- Operating voltage range : 1.8 V to 5.5 V
- Wide Timekeeper voltage range : 1.0 V to 5.5 V / Ta = +25 °C
- Low backup current : 275 nA / 3.0 V(Typ.)
- 32.768kHz frequency output function : C-MOS output With Control Pin
- The various functions include full calendar, alarm, timer, and power supply voltage monitoring function.
- Complies with EU RoHS directive

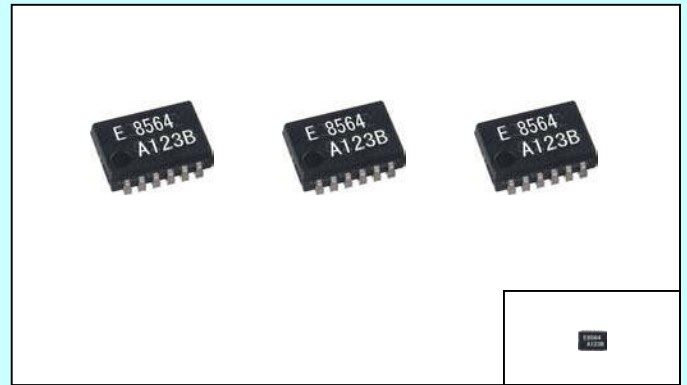

Actual size

* Refer to application manual for details.

* The I²C-Bus is a trademark of Philips Electronics N.V.

<http://www.epsondevice.com>

■ Block diagram

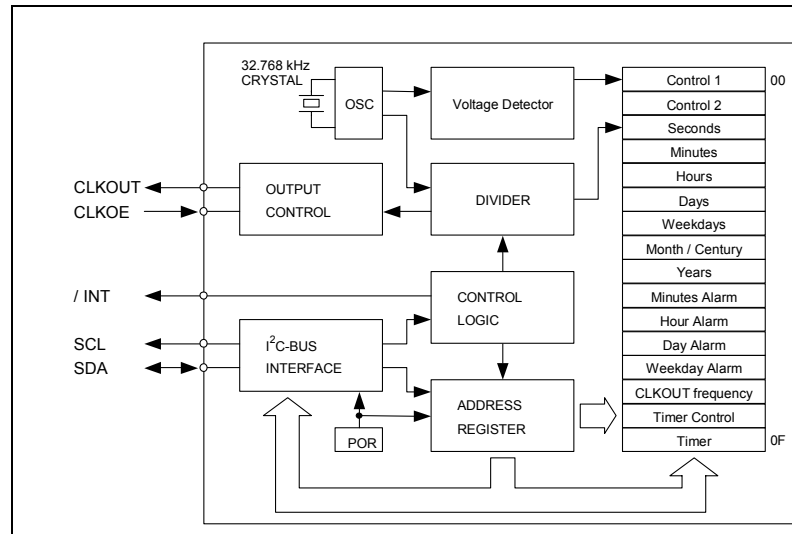

■ Overview

- Interface Type
 - I²C hi-speed bus specifications. (400 kHz)
 - I²C-Bus slave address : read A3h and write A2h
 - Low Timekeeper voltage
 - 1.0 V to 5.5 V / Ta = +25 °C
 - 1.3 V to 5.5 V / Ta = -40 °C to +85 °C
 - 32.768 kHz frequency output function
 - CLKOUT pin output (C-MOS output), CL=30 pF
 - CLKOE pin enables output on/off control.
 - Output selectable <32.768 kHz, 1024 Hz, 32 Hz, 1 Hz>
 - The various interrupt function
 - Timer function can be set up between 1/4096 second and 255 minutes.
 - Alarm function can be set to any combination of day of week, hour, or minute.
- * Functions are compatible with RTC-8564 JE / NB series.

■ Pin Function

Signal Name	Input / Output	Function													
SCL	Input	Serial clock input pin													
SDA	Bi-directional	Data input and output pin													
CLKOUT	Output	CLKOUT pin is 32.768 kHz clock output pin (C-MOS) that output control is possible. CLKOE pin control the frequency output from CLKOUT pin with FE-bit, FD1-bit, FD0-bit.													
CLKOE	Input	<table border="1"> <thead> <tr> <th>CLKOE pin input</th> <th>FE bit</th> <th>CLKOUT pin output</th> </tr> </thead> <tbody> <tr> <td rowspan="2">HIGH</td> <td>1</td> <td>Output (C-MOS)</td> </tr> <tr> <td>0</td> <td>OFF (LOW)</td> </tr> <tr> <td rowspan="2">LOW</td> <td>1</td> <td>OFF (LOW)</td> </tr> <tr> <td>0</td> <td>OFF (LOW)</td> </tr> </tbody> </table>	CLKOE pin input	FE bit	CLKOUT pin output	HIGH	1	Output (C-MOS)	0	OFF (LOW)	LOW	1	OFF (LOW)	0	OFF (LOW)
CLKOE pin input	FE bit	CLKOUT pin output													
HIGH	1	Output (C-MOS)													
	0	OFF (LOW)													
LOW	1	OFF (LOW)													
	0	OFF (LOW)													
/INT	Output	Interrupt output (N-ch open drain)													
VDD	—	Connected to a positive power supply.													
GND	—	Connected to a ground.													

■ Terminal connection / External dimensions (Unit:mm)

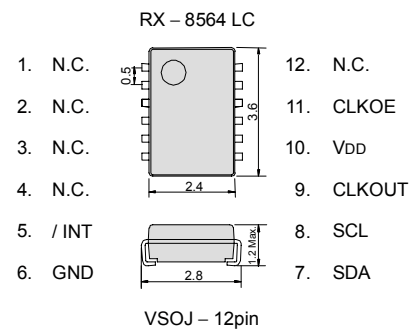

■ Specifications (characteristics)

■ Recommended Operating Conditions						
Item	Symbol	Condition	Min.	Typ.	Max.	Unit
Power voltage	VDD	—	1.8	3.0	5.5	V
Clock voltage	VCLK	—	V _{LOW}	3.0	5.5	V
Operating temperature	TOPR	—	-40	+25	+85	°C

■ Low voltage detection						
Item	Symbol	Condition	Min.	Typ.	Max.	Unit
Low voltage detection	V _{LOW}	Ta = +25 °C		0.9	1.0	V
		Ta = -20 °C to +70 °C		0.9	1.2	V
		Ta = -40 °C to +85 °C		0.9	1.3	V

■ DC characteristics						
Item	Symbol	Condition	Min.	Typ.	Max.	Unit
Current Consumption	I _{BK}	f _{SCL} = 0 Hz CLKOE = GND	V _{DD} = 5 V	330	800	nA
		CLKOUT ; output OFF (LOW)	V _{DD} = 3 V	275	700	nA
	I _{32k}	f _{SCL} = 0 Hz CLKOE = V _{DD}	V _{DD} = 5 V	2.5	3.4	μA
CLKOUT ; 32.768 kHz Output ON (Output=OPEN ; CL = 0 pF)	V _{DD} = 3 V	1.5	2.2			

I²C-Bus INTERFACE REAL TIME CLOCK MODULE

RX - 8581 SA / JE / NB

Product Number (please contact us)

RX - 8581 SA : Q41858151xxxx00

RX - 8581 JE : Q41858171xxxx00

RX - 8581 NB : Q41858191000200

- Built-in frequency adjusted 32.768 kHz crystal unit.
- Interface Type : I²C-Bus Interface (400 kHz)
- Operating voltage range : 1.8 V to 5.5 V
- Wide Timekeeper voltage range : 1.6 V to 5.5 V
- Low backup current : 0.45 μA / 3 V (Typ.)
- 32.768kHz frequency output function : C-MOS output With Control Pin
- The various functions include full calendar, alarm, timer.
- Complies with EU RoHS directive

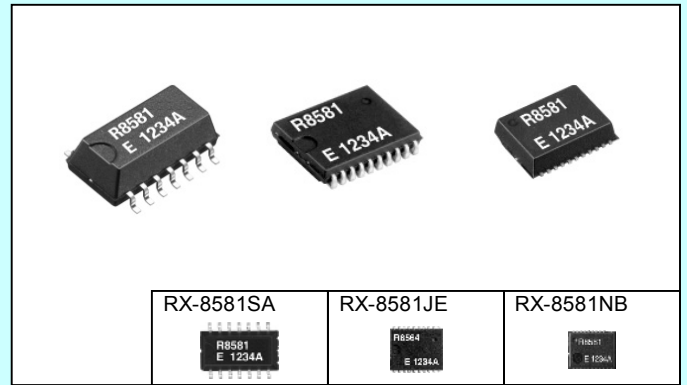

Actual size

* Refer to application manual for details.

* The I²C-Bus is a trademark of Philips Electronics N.V.

<http://www.epsondevice.com>

Block diagram

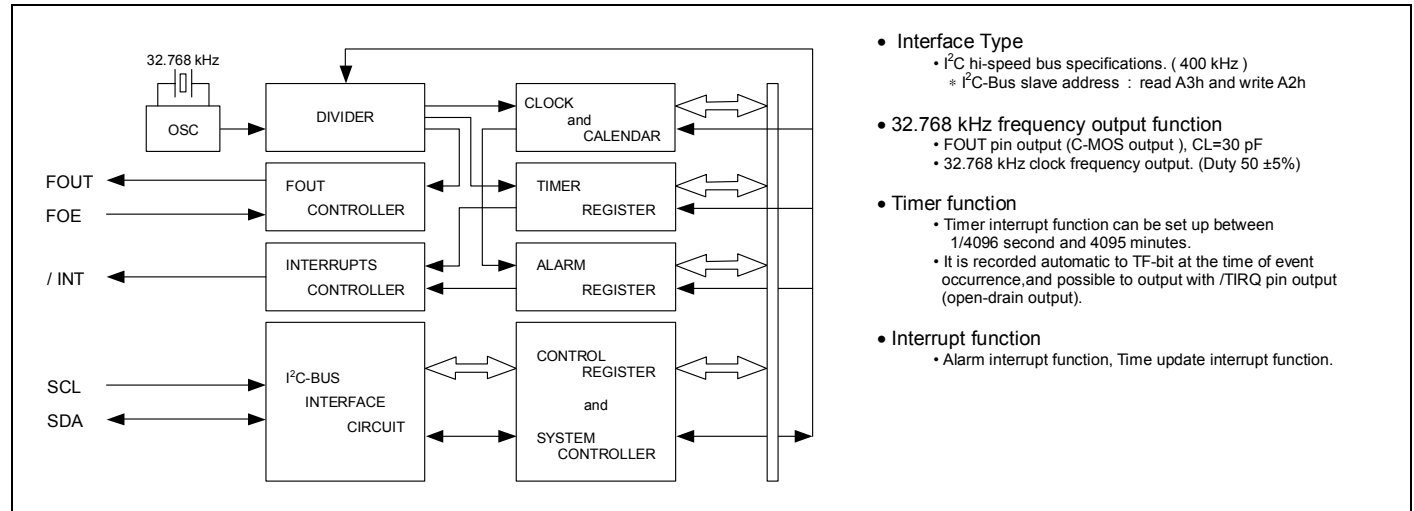

Overview

- Interface Type
 - I²C hi-speed bus specifications. (400 kHz)
 - I²C-Bus slave address : read A3h and write A2h
- 32.768 kHz frequency output function
 - FOUT pin output (C-MOS output), CL=30 pF
 - 32.768 kHz clock frequency output. (Duty 50 ±5%)
- Timer function
 - Timer interrupt function can be set up between 1/4096 second and 4095 minutes.
 - It is recorded automatic to TF-bit at the time of event occurrence, and possible to output with /TIRQ pin output (open-drain output).
- Interrupt function
 - Alarm interrupt function, Time update interrupt function.

Terminal connection / External dimensions

(Unit:mm)

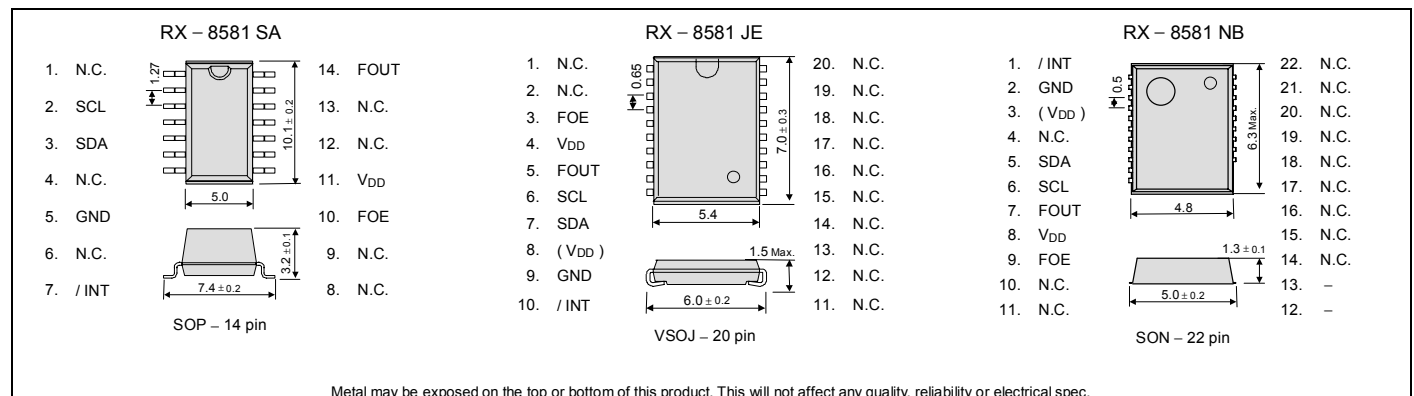

Metal may be exposed on the top or bottom of this product. This will not affect any quality, reliability or electrical spec.

Specifications (characteristics)

Recommended Operating Conditions						
Item	Symbol	Condition	Min.	Typ.	Max.	Unit
Power voltage	VDD	—	1.8	3.0	5.5	V
Clock voltage	VCLK	—	1.6	3.0	5.5	V
Operating temperature	TOPR	—	-40	+25	+85	°C

Frequency characteristics				
Item	Symbol	Condition	Rating	Unit
Frequency tolerance	$\Delta f / f$	T _a = +25 °C VDD = 3.0 V	5 ± 23 *	× 10 ⁻⁶
FOUT output Duty	tw / t	T _a = -40 °C to +85 °C VDD = 2.4 V to 5.5 V	50 ± 5	%

* Please ask for tighter tolerance. (Equivalent to 1 minute of monthly deviation)

DC characteristics						
T _a = -40 °C to +85 °C						
Item	Symbol	Condition	Min.	Typ.	Max.	Unit
Current Consumption	IBK	f _{SCL} = 0 Hz FOE = GND	VDD = 5 V	0.65	1.2	μA
		FOUT ; output OFF (LOW)	VDD = 3 V	0.45	0.8	
	I32k	f _{SCL} = 0 Hz FOE = VDD	VDD = 5 V	8.0	20.0	μA
		FOUT ; 32.768 kHz output ON CL = 30 pF	VDD = 3 V	5.0	12.0	

FOR AUTOMOTIVE
I²C-Bus INTERFACE REAL TIME CLOCK MODULE
RA - 8581 SA

Product Number (please contact us)
RA - 8581 SA : Q41A88151xxxx00

- Built-in frequency adjusted 32.768 kHz crystal unit.
- Interface Type : I²C-Bus Interface (400 kHz)
- Operating voltage range : 1.8 V to 5.5 V
- Wide Timekeeper voltage range : 1.6 V to 5.5 V
- Low backup current : 0.45 μA / 3 V (Typ.)
- 32.768kHz frequency output function : C-MOS output With Control Pin
- The various functions include full calendar, alarm, timer.
- Complies with EU RoHS directive

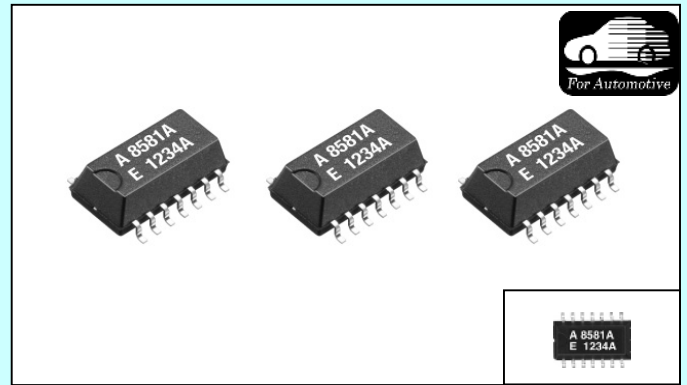

Actual size

* Refer to application manual for details.

* The I²C-Bus is a trademark of Philips Electronics N.V.

<http://www.epsondevice.com>

■ **Block diagram**

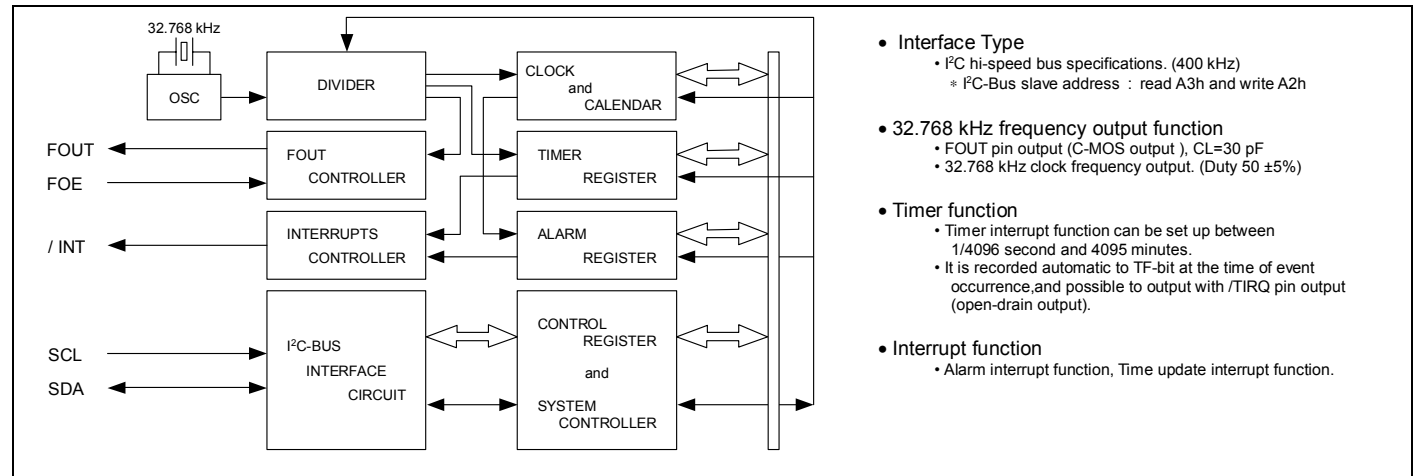

■ **Overview**

- **Interface Type**
 - I²C hi-speed bus specifications. (400 kHz)
 - I²C-Bus slave address : read A3h and write A2h
- **32.768 kHz frequency output function**
 - FOUT pin output (C-MOS output), CL=30 pF
 - 32.768 kHz clock frequency output. (Duty 50 ±5%)
- **Timer function**
 - Timer interrupt function can be set up between 1/4096 second and 4095 minutes.
 - It is recorded automatic to TF-bit at the time of event occurrence, and possible to output with /TIRQ pin output (open-drain output).
- **Interrupt function**
 - Alarm interrupt function, Time update interrupt function.

■ **Pin Function**

Signal Name	Input / Output	Function						
SCL	Input	Serial clock input pin						
SDA	Bi-directional	Data input and output pin						
FOUT	Output	FOUT pin outputs the reference clock signal at 32.768 kHz. FOE pin inputs the FOUT output control.						
FOE	Input	<table border="1"> <thead> <tr> <th>FOE pin input</th> <th>FOUT pin output</th> </tr> </thead> <tbody> <tr> <td>HIGH</td> <td>Output (C-MOS)</td> </tr> <tr> <td>LOW</td> <td>OFF (LOW)</td> </tr> </tbody> </table>	FOE pin input	FOUT pin output	HIGH	Output (C-MOS)	LOW	OFF (LOW)
FOE pin input	FOUT pin output							
HIGH	Output (C-MOS)							
LOW	OFF (LOW)							
/INT	Output	Interrupt output (N-ch open drain)						
VDD	—	Connected to a positive power supply.						
GND	—	Connected to a ground.						

■ **Terminal connection / External dimensions (Unit:mm)**

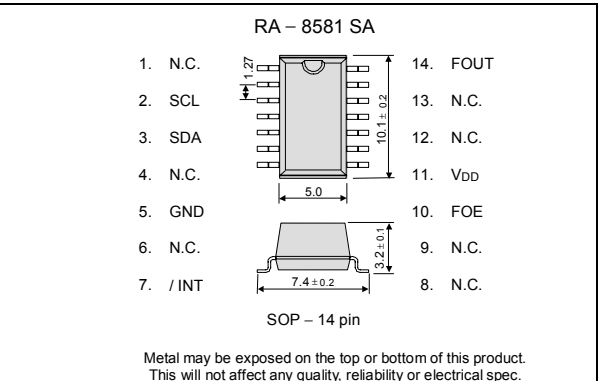

■ **Specifications (characteristics)**

■ Recommended Operating Conditions						
Item	Symbol	Condition	Min.	Typ.	Max.	Unit
Power voltage	VDD	—	1.8	3.0	5.5	V
Clock voltage	VCLK	—	1.6	3.0	5.5	V
Operating temperature	TOPR	—	-40	+25	+85	°C

■ Frequency characteristics				
Item	Symbol	Condition	Rating	Unit
Frequency tolerance	Δf/f	Ta = +25 °C VDD = 3.0 V	5 ± 23 *	× 10 ⁻⁶
FOUT output Duty	tw / t	Ta = -40 °C to +85 °C VDD = 2.4 V to 5.5 V	50 ± 5	%

* Please ask for tighter tolerance. (Equivalent to 1 minute of monthly deviation)

■ DC characteristics						
Item	Symbol	Condition	Min.	Typ.	Max.	Unit
Current Consumption	IBK	fSCL = 0 Hz FOE = GND FOUT ; Output OFF (LOW)	VDD = 5 V	0.65	1.2	μA
			VDD = 3 V	0.45	0.8	
Current Consumption	I32k	fSCL = 0 Hz FOE = VDD FOUT ; 32.768 kHz Output ON CL = 30 pF	VDD = 5 V	8.0	20.0	μA
			VDD = 3 V	5.0	12.0	

4-bit REAL TIME CLOCK MODULE

RTC-7301SF / DG

Product number (please contact us)

RTC-7301SF : Q42730181000200
 RTC-7301DG : Q42730111000200

- Built-in crystal oscillator 32.768 kHz with frequency adjusted
- Frequency selectable clock output (32.768 kHz to 1/30 Hz)
- Built-in 30 second adjustment function, digital pace adjustment function (Max. adjustment: $\pm 192 \times 10^{-6}$)
- Built-in alarm and timer interrupt functions.
- Built-in semiconductor temperature sensor (Voltage output: -7.8 mV / °C, RTC-7301SF)
- Operating voltage range: 2.4 V to 5.5 V, time keeping voltage range: 1.6 V to 5.5 V
- Low current consumption (0.6 μ A / 3 V Typ.)
- High speed parallel interface compatible with SRAM
- Complies with EU RoHS directive

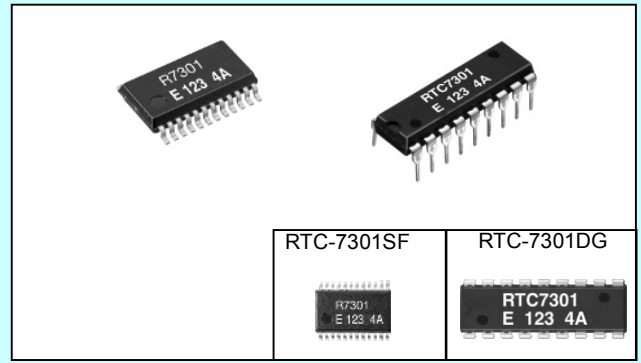

Actual size

Refer to application manual for details.

<http://www.epsondevice.com>

Block diagram

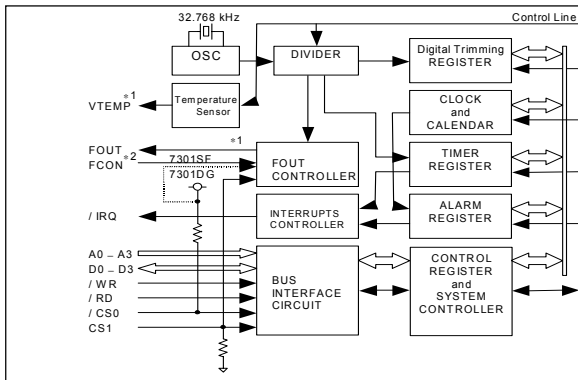

This is a block diagram for RTC-7301SF.

Be aware that RTC-7301DG differs according to the following 2 points.

- *1) The VTEMP output is not connected to an external pin.
- *2) The FCON input pin is not connected to an external pin, but is fixed at "H" internally.

Specifications (characteristics)

Absolute Max. rating

GND=0 V

Item	Symbol	Condition	Min.	Max.	Unit
Supply voltage	V _{DD}	V _{DD} to GND	-0.3	+7.0	
Input voltage	V _{IN}	Input terminal, D ₀ to D ₃ pins	GND-0.3	V _{DD} +0.3	V
Output voltage(1)	V _{OUT1}	/IRQ pin		+8.0	
Output voltage(2)	V _{OUT2}	F _{OUT} , D ₀ -D ₃ , V _{TEMP} pin		V _{DD} +0.3	
Storage temperature	T _{STG}	Stored as bare product after unpacking	-55	+125	°C

Operating range

GND = 0 V

Item	Symbol	Condition	Min.	Max.	Unit
Power voltage	V _{DD}	—	2.4	5.5	V
Clock voltage	V _{CLK}	—	1.6	5.5	V
Operating temperature	T _{OPR}	No condensation	-40	+85	°C

Frequency characteristics

Item	Symbol	Condition	Range	Unit
Frequency precision	$\Delta f / f$	T _a =+25 °C, V _{DD} =3.0 V	B:5±23 (**1)	×10 ⁻⁶
Oscillation Start up time	t _{STA}	T _a =+25 °C, V _{DD} =2.4 V	3.0 Max.	s
Frequency temperature characteristics	T _{OP}	T _a =-10 °C to +70 °C V _{DD} =3.0 V, +25 °C	+10 / -120	×10 ⁻⁶
Frequency voltage characteristics	f/V	T _a =+25 °C, V _{DD} =1.6 V to 5.5 V	±2.0 Max.	×10 ⁻⁶ /V
Aging	f _a	T _a =+25 °C, V _{DD} =3.0 V First year	±5.0 Max.	×10 ⁻⁶ /year

(*1) Please ask tighter tolerance

DC characteristics

(GND=0 V, V_{DD}=1.6 V to 5.5 V, T_a=-40 °C to +85 °C)

Item	Symbol	Condition	Min.	Typ.	Max.	Unit	
Current consumption (When non-accessed) F _{OUT} =Output OFF V _{TEMP} =Output OFF	I _{DD1}	/CS ₀ /RD, /WR=V _{DD} A ₀ -A ₃ , CS ₁ =GND D ₀ -D ₃ /IRQ=Hi-Z	V _{DD} =5 V	—	1.0	2.0	μA
	I _{DD2}	F _{OUT} =Hi-Z(OFF) V _{TEMP} =Hi-Z(OFF)		V _{DD} =3 V	—	0.6	

Note) There is no V_{TEMP} pin on the RTC-7301DG so standards for the V_{TEMP} pin within the conditions described above do not apply.

Temperature sensor characteristics

GND=0 V, T_a=-40 °C to +85 °C

Item	Symbol	Condition	Min.	Typ.	Max.	Unit
Temperature output voltage	V _{TEMP}	T _a =+25 °C, GND based output voltage V _{TEMP} pins, V _{DD} =2.7 V to 5.5 V		1.470		V
Output precision	T _{ACR}	T _a =+25 °C, V _{DD} =2.7 V to 5.5 V			±5.0	°C
Temperature sensitivity	V _{SE}	-40 °C ≤ T _a ≤ +85 °C, V _{DD} =2.7 V to 5.5 V	-7.3	-7.8	-8.3	mV / °C
Linearity	ΔNL	-40 °C ≤ T _a ≤ +85 °C, V _{DD} =2.7 V to 5.5 V			±2.0	%
Temperature detection range	T _{SOP}	ΔNL ≤ ±2.0 %, V _{DD} =2.7 V to 5.5 V	-40		+85	°C
Output resistance	R ₀	T _a =25 °C, V _{TEMP} pins, V _{DD} =2.7 V to 5.5 V GND standard and V _{DD} standard		1.0	3.0	kΩ
Load condition	C _L	V _{DD} =2.7 V to 5.5 V			100	pF
	R _L	V _{DD} =2.7 V to 5.5 V	500			kΩ
Response time	t _{rsp}	V _{DD} =3.3 V C _L =50 pF, R _L =500 kΩ, Max. ±1 °C			200	μs

Note) There is no temperature sensor function on the RTC-7301DG.

External dimensions/Terminal connection

(Unit:mm)

RTC-7301SF (SSOP 24-pin)

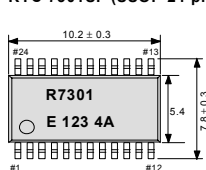

No.	Pin terminal	No.	Pin terminal
1	/CS0	24	V _{DD}
2	FCON	23	(V _{DD})
3	FOUT	22	(V _{DD})
4	VTEMP	21	(V _{DD})
5	V _{DD}	20	(V _{DD})
6	/IRQ	19	(V _{DD})
7	A ₀	18	CS ₁
8	A ₁	17	D ₀
9	A ₂	16	D ₁
10	A ₃	15	D ₂
11	/RD	14	D ₃
12	GND	13	/WR

RTC-7301DG (DIP 18-pin)

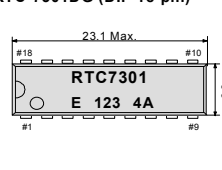

No.	Pin terminal	No.	Pin terminal
1	/CS0	18	V _{DD}
2	FOUT	17	(V _{DD})
3	/IRQ	16	(V _{DD})
4	A ₀	15	CS ₁
5	A ₁	14	D ₀
6	A ₂	13	D ₁
7	A ₃	12	D ₂
8	/RD	11	D ₃
9	GND	10	/WR

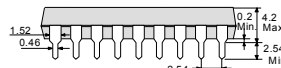
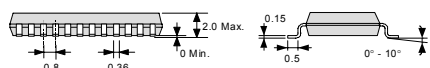

Metal may be exposed on the top or bottom of this product. This will not affect any quality, reliability or electrical spec.

4-bit REAL TIME CLOCK MODULE

RTC - 62421 / 62423

Product number (please contact us)

RTC-62421 : Q42624211xxxx00
 RTC-62423 : Q42624231xxxx00

- Built-in crystal unit allows adjustment-free efficient operation.
- 24 h / 12 h changeable and leap year automatically adjustable (Gregorian calendar).
- Pins and functions are compatible with the MSM6242 series.
- Complies with EU RoHS directive.

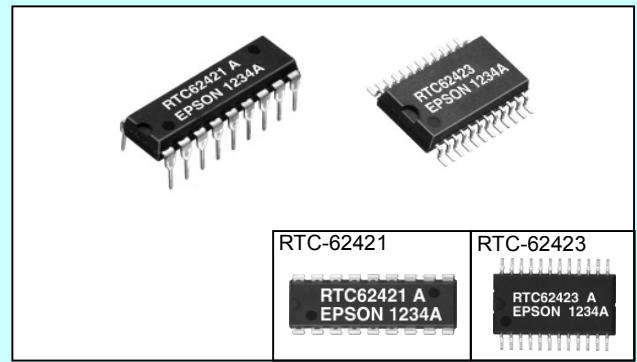

Actual size

Refer to application manual for details.

<http://www.epsondevice.com>

■ Block diagram

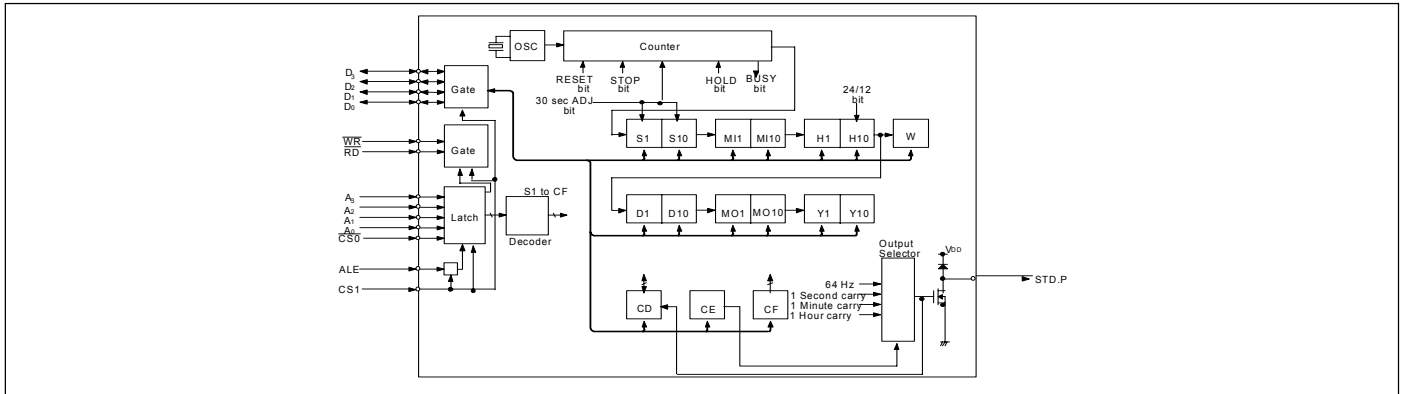

■ Specifications (characteristics)

■ Absolute Max. rating

Item	Symbol	Condition	Min.	Max.	Unit
Supply voltage	V _{DD}	T _a =+25 °C	-0.3	+7.0	V
Input voltage	V _{IO}	T _a =+25 °C	GND-0.3	V _{DD} +0.3	V
Storage temperature *	T _{STG}	RTC-62421	-55	+85	°C
		RTC-62423	-55	+125	°C

*Stored as bare product after unpacking

■ Operating range

Item	Symbol	Condition	Min.	Max.	Unit
Power voltage	V _{DD}	—	4.5	5.5	V
Clock voltage	V _{CLK}	—	2.0	5.5	V
Operating temperature	T _{OPR}	Stored as bare product after unpacking	-40	+85	°C

■ Frequency characteristics

Item	Symbol	Condition	Range	Unit
Frequency precision	Δf / f	T _a =+25 °C V _{DD} =5.0 V	62421A	±10
			62421B	±50
			62423A	±20
			62423	±50
Frequency temperature characteristics	T _{OP}	-10 °C to +70 °C (+25 °C)	+10 / -120	
		-40 °C to +85 °C (+25 °C)	+10 / -220	
Frequency voltage characteristics	f/V	T _a =+25 °C, V _{DD} =4.5 V to 5.5 V	±5.0 Max.	×10 ⁻⁶ /V
Aging	fa	T _a =+25 °C, V _{DD} =5.0 V, First year	±5.0 Max.	×10 ⁻⁶ /year

■ DC characteristics

Item	Symbol	Condition	Min.	Typ.	Max.	Unit	Applicable terminal
Current consumption	I _{DD1}	CS ₁ = 0 V	—	15	30	μA	—
	I _{DD2}	V _{DD} =5 V V _{DD} =2 V	—	1	1.8	μA	—
"H" input voltage (1)	V _{IH1}	—	2.2	—	—	V	All inputs other than CS ₁
"L" input voltage (1)	V _{IL1}	—	—	—	0.8	V	All inputs other than CS ₁
"L" output voltage (1)	V _{OL1}	I _{OL} =2.5 mA	—	—	0.4	V	D ₀ to D ₃
"H" output voltage	V _{OH}	I _{OH} =-400 μA	2.4	—	—	V	D ₀ to D ₃
"L" output voltage (2)	V _{OL2}	I _{OL} =2.5 mA	—	—	0.4	V	STD.P
OFF leak current	I _{OFFLK}	V _I =V _{DD} /0 V	—	—	10/-10	μA	—
Input capacity	C _I	Input frequency 1 MHz	—	5	—	pF	Input Pins
"H" input voltage (2)	V _{IH2}	V _{DD} =2.0 V to 5.5 V	4/5 V _{DD}	—	—	V	CS ₁
"L" input voltage (2)	V _{IL2}	V _{DD} =2.0 V to 5.5 V	—	—	1/5 V _{DD}	V	CS ₁
Input leak current (1)	I _{LK1}	V _I =V _{DD} /0 V	—	—	1/-1	μA	Input other than D ₀ to D ₃
Input leak current (2)	I _{LK2}	V _I =V _{DD} /0 V	—	—	10/-10	μA	D ₀ to D ₃

■ Terminal connection/External dimensions

(Unit:mm)

● RTC-62421 (DIP 18-pin)

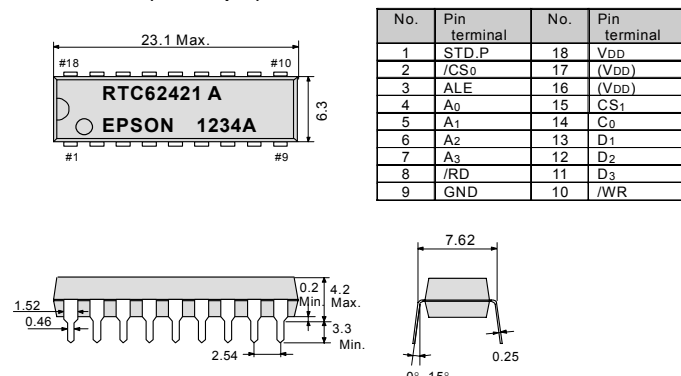

● RTC-62423 (SOP 24-pin)

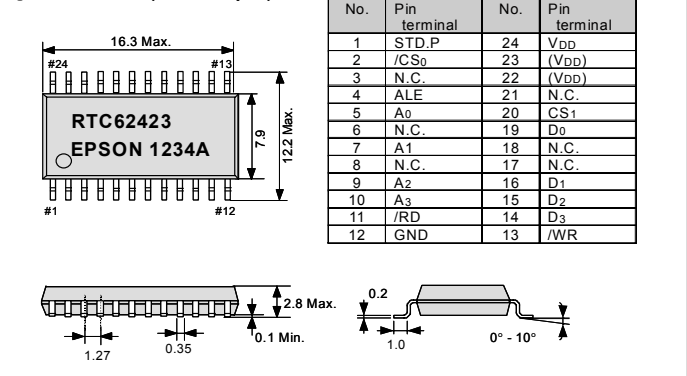

Metal may be exposed on the top or bottom of this product. This will not affect any quality, reliability or electrical spec.

4-bit REAL TIME CLOCK MODULE

RTC - 72421 / 72423

Product number (please contact us)

RTC-72421 : Q42724211xxxx00
 RTC-72423 : Q42724231xxxx00

- Built-in crystal unit allows adjustment-free efficient operation.
- 24 h / 12 h changeable and leap year automatically adjustable (Gregorian calendar).
- Complies with EU RoHS directive.

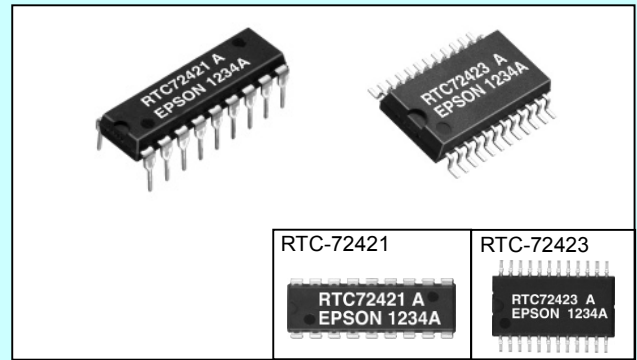

Refer to application manual for details.

Actual size

■ Block diagram

<http://www.epsondevice.com>

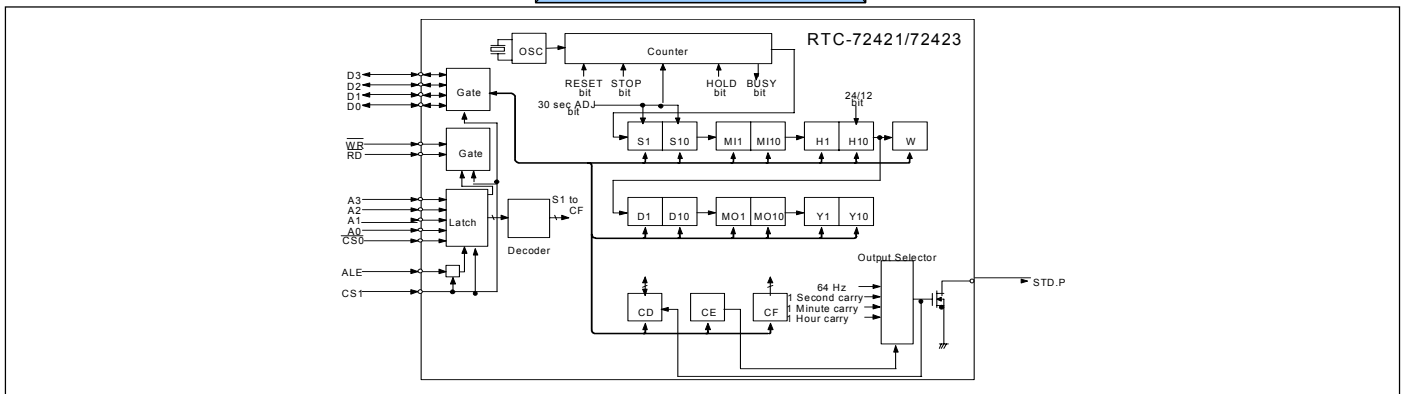

■ Specifications (characteristics)

■ Absolute Max. rating

Item	Symbol	Condition	Min.	Max.	Unit
Supply voltage	V _{DD}	T _a =+25 °C	-0.3	+7.0	V
Input voltage	V _{I/O}	T _a =+25 °C	GND-0.3	V _{DD} +0.3	V
Storage temperature *	T _{STG}	RTC-72421	-55	+85	°C
		RTC-72423	-55	+125	°C

*Stored as bare product after unpacking

■ Operating range

Item	Symbol	Condition	Min.	Max.	Unit
Power voltage	V _{DD}	—	4.5	5.5	V
Clock voltage	V _{CLK}	—	2.0	5.5	V
Operating temperature	T _{OPR}	RTC-72421	-10	+70	°C
		RTC-72423	-40	+85	°C

Stored as bare product after unpacking

■ Frequency characteristics

Item	Symbol	Condition	Range	Unit
Frequency precision	Δf/f	T _a =+25 °C V _{DD} =5.0 V	72421A	±10
			72421B	±50
			72423A	±20
			72423	±50
Frequency temperature characteristics	TOP	-10 °C to +70 °C (+25 °C)	+10 / -120	×10 ⁻⁶
		-40 °C to +85 °C (+25 °C)	+10 / -220	
Frequency voltage characteristics	f/V	T _a =+25 °C, V _{DD} =2.0 V to 5.5 V	±5.0 Max.	×10 ⁻⁶ /V
Aging	fa	T _a =+25 °C, V _{DD} =5.0 V, First year	±5.0 Max.	×10 ⁻⁶ /year

■ DC characteristics

Item	Symbol	Condition	Min.	Typ.	Max.	Unit	Applicable terminal
Current consumption	I _{DD1}	CS ₁ =0 V	—	1	10	μA	—
	I _{DD2}	Exclude input/output current V _{DD} =2 V	—	0.9	5		—
"H" input voltage (1)	V _{IH1}	—	2.2	—	—	V	All inputs other than CS ₁
"L" input voltage (1)	V _{IL1}	—	—	—	0.8	V	—
"L" output voltage (1)	V _{OL1}	I _{OL} =2.5 mA	—	—	0.4	V	D ₀ to D ₃
"H" output voltage	V _{OH}	I _{OH} =-400 μA	2.4	—	—	V	—
"L" output voltage (2)	V _{OL2}	I _{OL} =2.5 mA	—	—	0.4	V	STD.P
OFF leak current	I _{OFFLK}	V _I =V _{DD} /0 V	—	—	10/-10	μA	—
Input capacity	C ₁	Input frequency 1 MHz	—	10	—	pF	Input other than D ₀ to D ₃
			—	20	—		D ₀ to D ₃ , STD.P
"H" input voltage (2)	V _{IH2}	V _{DD} =2.0 V to 5.5 V	4/5 V _{DD}	—	—	V	CS ₁
"L" input voltage (2)	V _{IL2}	—	—	—	1/5 V _{DD}	V	—
Input leak current (1)	I _{LK1}	V _I =V _{DD} /0 V	—	—	1/-1	μA	Input other than D ₀ to D ₃
Input leak current (2)	I _{LK2}	—	—	—	10/-10	μA	D ₀ to D ₃

■ Terminal connection/External dimensions

(Unit:mm)

● RTC-72421 (DIP 18-pin)

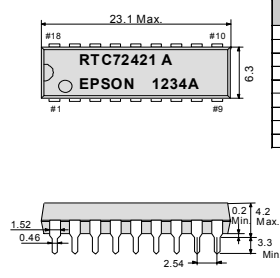

● RTC-72423 (SOP 24-pin)

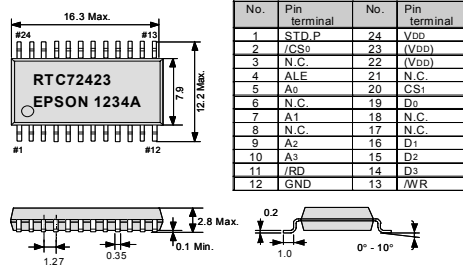

Metal may be exposed on the top or bottom of this product. This will not affect any quality, reliability or electrical spec.

SAW Filter

FF-32N

Product number (please contact us)

Q51FF32N0xxxx00

- Frequency range : 310 MHz to 435 MHz
- Thickness : 0.98 mm Typ.
- Applications : Wireless remote-control, Security (Automotive keyless entry, ARIB std. T67 in Japan)
- Lead(Pb)-free : Complies with EU RoHS directive (Lead free completely)
- Filter of low impedance by an original design.
- Low-loss, Narrow Pass bandwidth, High stability by using crystal substrate.

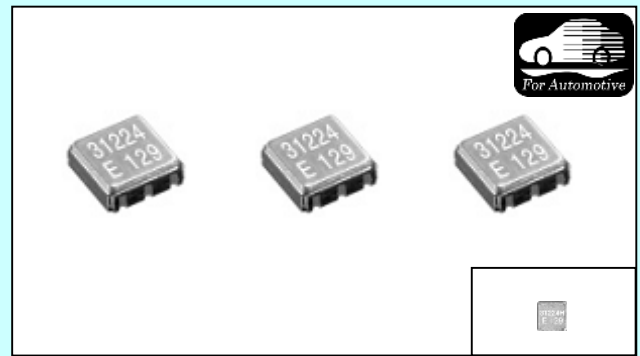

Actual size

■ Specifications (characteristics)

Item	Symbol	Specifications		Remarks	
Nominal frequency range	f _N	310 MHz to 435 MHz	426 MHz , 429 MHz band*	*ARIB std. T67 in Japan	
Temperature range	Storage temperature range	TSTG	-55 °C to +125 °C	-55 °C to +125 °C	Stored as bare product after unpacking
	Operable temperature	TOPR	-40 °C to +85 °C	-10 °C to +60 °C	
Insertion Loss	IL	3.5 dB Max.	3.5 dB Max.	Minimum Loss	
Pass bandwidth	BW3	f _N ±200 kHz Min.	f _N ±300 kHz Min.	Reference to minimum loss (3 dB down)	
Attenuation	ATT	f _N -21.4 MHz : 40 dBMin. f _N -10.7 MHz : 35 dBMin.	f _N -21.4 MHz : 40 dB Min. f _N -10.7 MHz : 35 dB Min.	Reference to minimum loss	
Peak temperature	ΘT	+25 °C ±15 °C	+25 °C ±15 °C		
Temperature coefficient	α	-(3.4±0.8) × 10 ⁻⁸ / °C ²	-(3.4±0.8) × 10 ⁻⁸ / °C ²		
Terminal impedance	Z	370 Ω Typ.		Ex: 315 MHz	
		160 Ω Typ.		Ex:433.92 MHz	
			220 Ω Typ.	Ex:429.45 MHz	

■ Test fixture

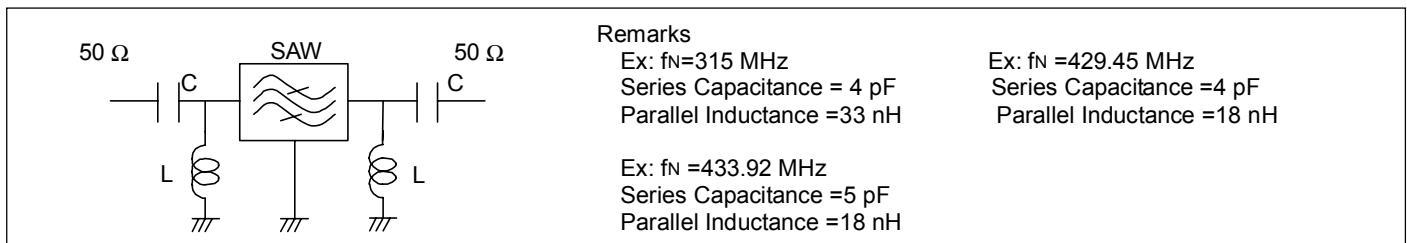

■ External dimension

(Unit:mm)

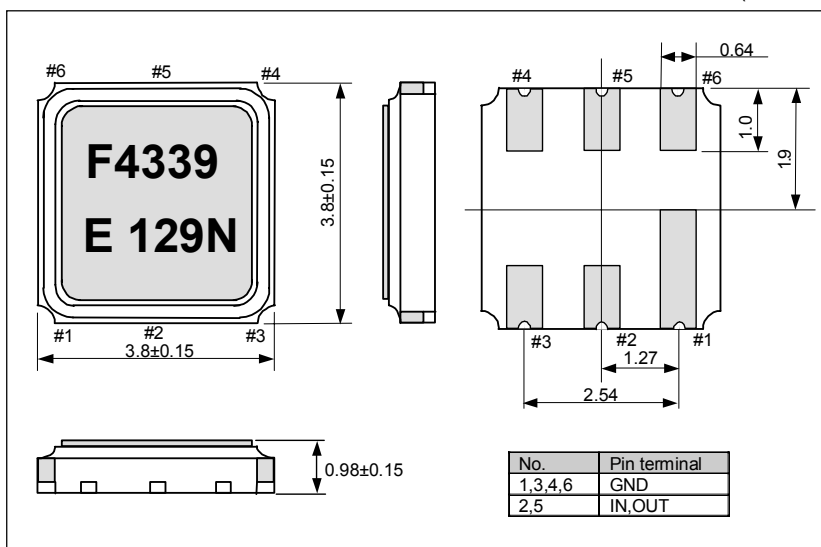

■ Recommended soldering pattern (Unit:mm)

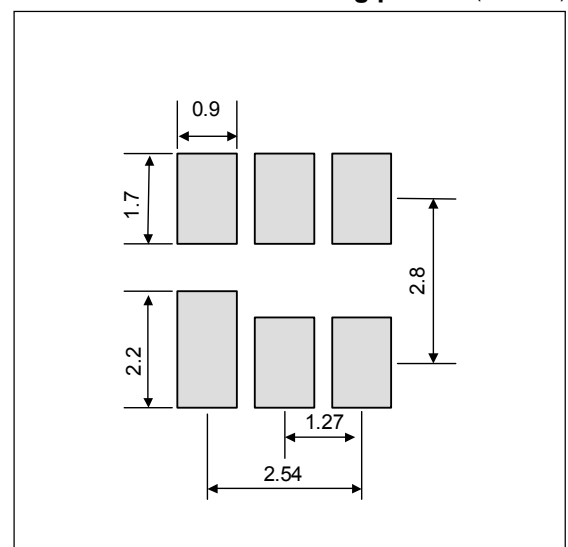

SAW Filter

FF - 555

Product number (please contact us)

Q51FF5550xxxx00

- Frequency range : 300 MHz to 500 MHz
- Thickness : 1.5 mm Typ.
- Applications : Wireless remote-control, Security (Automotive keyless entry)
- Lead(Pb)-free : Complies with EU RoHS directive (Lead free completely)
- Excellent shock resistance and environmental capability (prevention for contamination)
- Low-loss, Narrow Pass bandwidth, High stability by using crystal substrate.

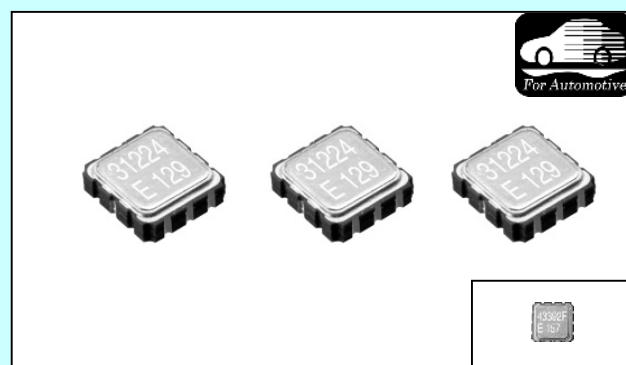

Actual size

■ Specifications (characteristics)

Item	Symbol	Specifications	Remarks	
Nominal frequency range	f _N	300 MHz to 500 MHz		
Temperature range	Storage temperature range	T _{STG}	-55 °C to +125 °C	Stored as bare product after unpacking
	Operable temperature	T _{OPR}	-40 °C to +85 °C	
Insertion Loss	IL	3.5 dB Max.	Minimum Loss	
Pass bandwidth	BW _{3.5}	f _N ± 100 kHz Min.	Reference to Through level (3.5 dB down)	
Attenuation	ATT	At f _N -21.4 MHz 40 dB Min. At f _N -10.7 MHz 40 dB Min.	Reference to Through level	
Peak temperature	Θ _T	+25 °C ±15 °C		
Temperature coefficient	α	$-(3.4 \pm 0.8) \times 10^{-8} / ^\circ\text{C}^2$		
Terminal impedance	Z	370 Ω Typ.	Ex : 315 MHz	
		260 Ω Typ.	Ex : 433.92 MHz	

■ Test fixture

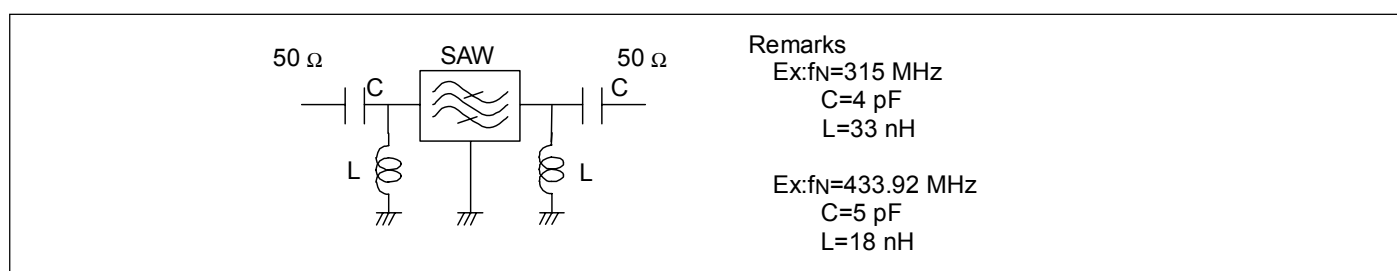

■ External dimensions

(Unit:mm)

■ Recommended soldering pattern (Unit:mm)

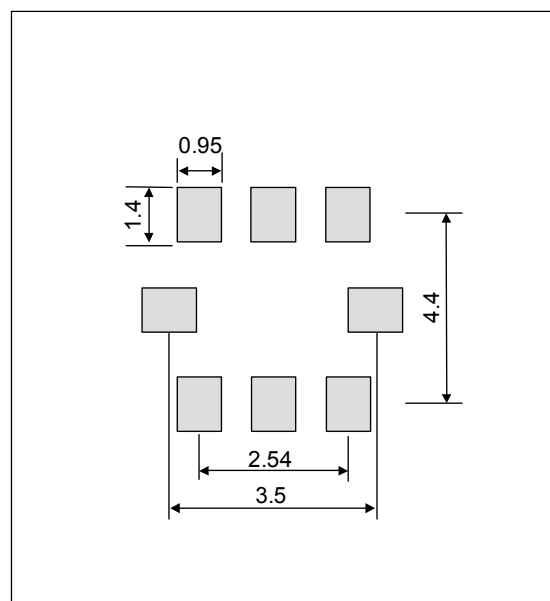
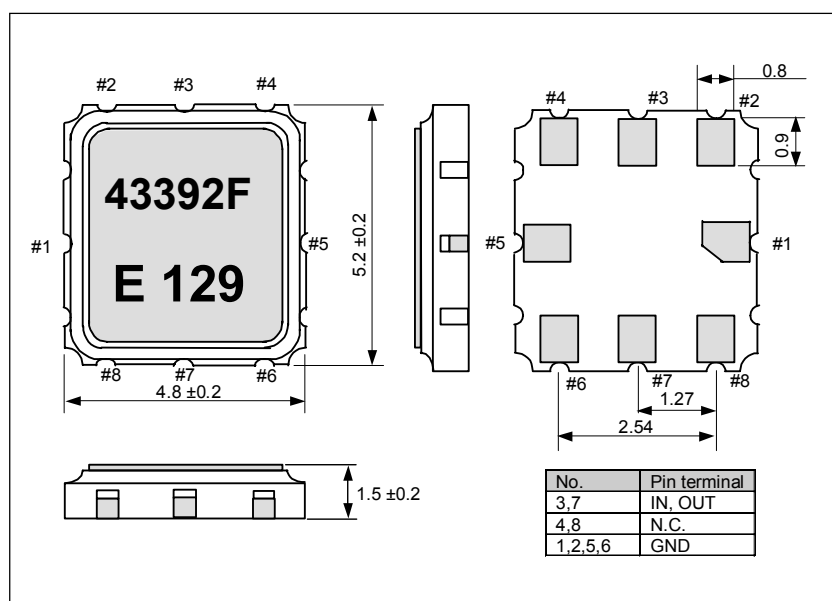

SAW FILTER FOR TPMS

FF - 585

Product number (please contact us)

Q51FF5850xxx00

- Frequency range : 300 MHz to 500 MHz
- Thickness : 1.5 mm Typ.
- Applications : Safety system(Automotive TPMS)
Wireless remote-control
Automotive keyless entry
- Lead(Pb)-free : Complies with EU RoHS directive
(Lead free completely)
- Excellent shock resistance and environmental capability
(prevention for contamination)
- Low-loss, Narrow Pass bandwidth, High stability by using
crystal substrate.

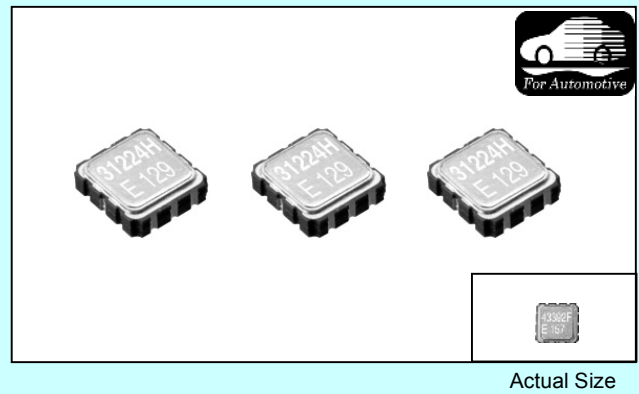

■ Specifications (characteristics)

Item	Symbol	Specifications	Remarks	
Nominal frequency range	f _N	300 MHz to 500 MHz		
Temperature range	Storage temperature range	T _{STG}	-55 °C to +125 °C	Stored as bare product after unpacking
	Operable temperature	T _{OPR}	-40 °C to +85 °C	
Insertion Loss	IL	3.5 dB Max.	Minimum Loss	
Pass bandwidth	BW3.5	f _N ± 200 kHz Min.	Reference to minimum loss (3.5 dB down)	
Attenuation	ATT	At f _N +21.4 MHz 40 dB Min. At f _N -21.4 MHz 40 dB Min.	Reference to Through level	
Peak temperature	Θ _T	+25 °C ±15 °C		
Temperature coefficient	α	-(3.4± 0.8) × 10 ⁻⁸ / °C ²		
Terminal impedance	Z	370 Ω Typ.	Ex : 315 MHz	
		260 Ω Typ.	Ex : 433.92 MHz	

■ Test fixture

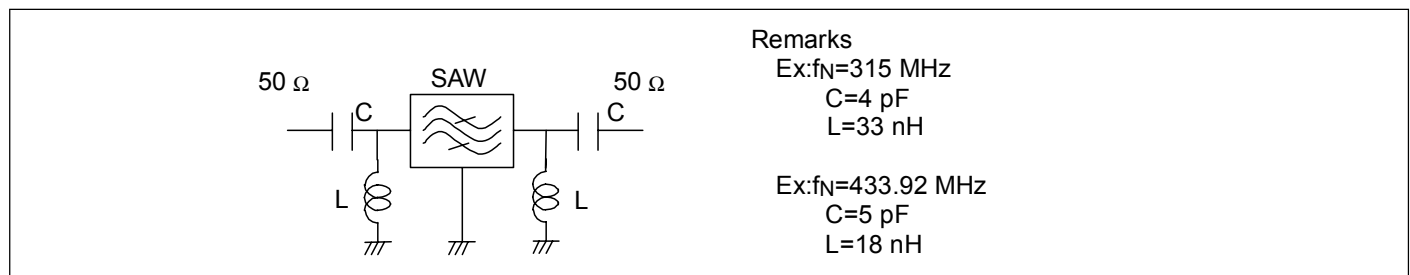

■ External dimensions

(Unit:mm)

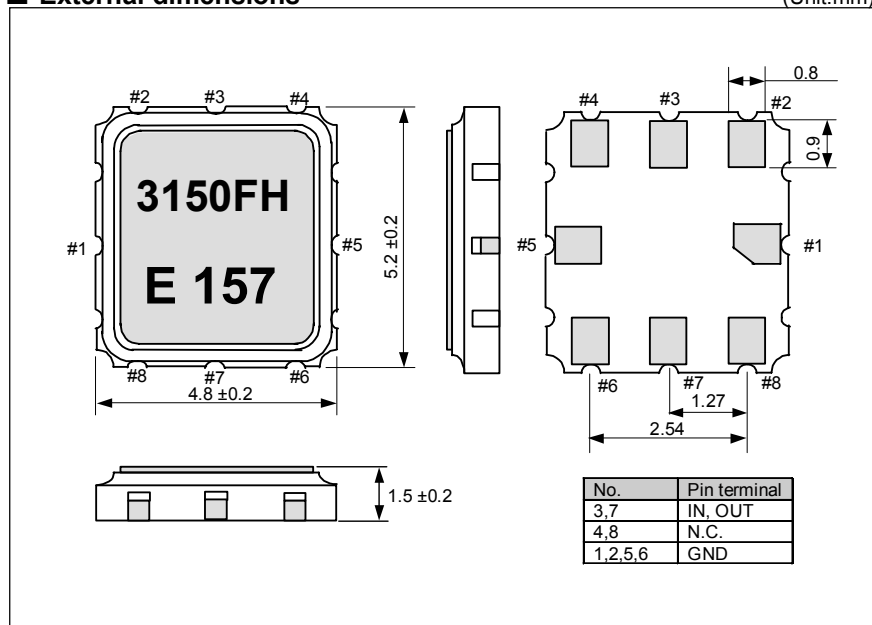

■ Recommended soldering pattern (Unit:mm)

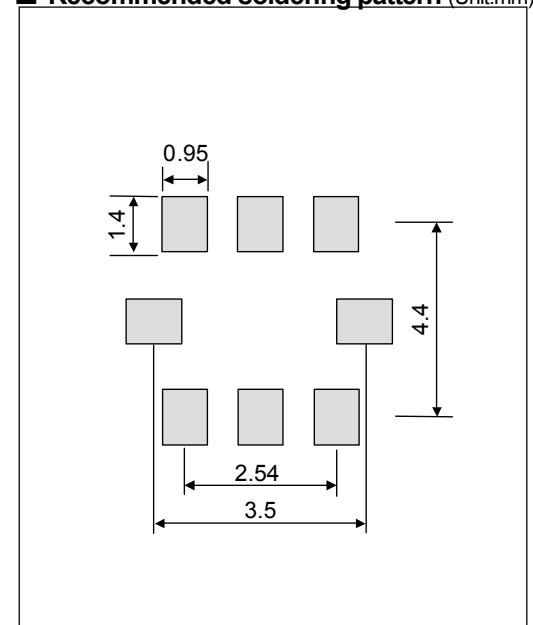

Ultra Small Vibration Gyro Sensor (angler rate sensor)

XV - 3500CB

Product number (please contact us)
Q71350020xxxx00

- Ultra Small Package size SMD(5 x 3.2 x 1.3 mm)
- Hermetic sealing provides excellent sustainable environmental capability
- High stability using vibration crystal
- Clipped startup time and low power consumption with sleep mode
- Complies with EU RoHS directive (Lead free completely)

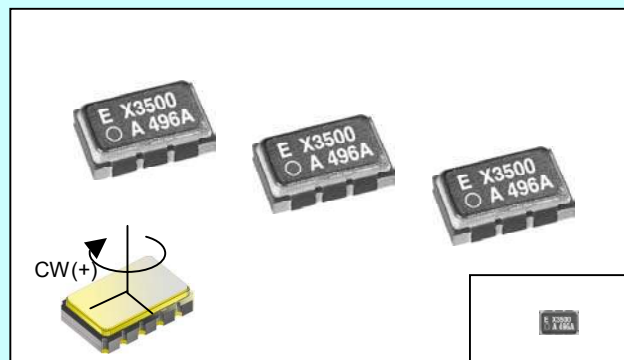

Actual size

Ideal application for use

- Detection picture stabilization of DVC and DSC
- Detection of moving with man machine interface

■ Specifications (characteristics)

■ Absolute Max. Rating

Item	Symbol	Specifications			Remarks
		Min.	Typ.	Max.	
Power Supply Voltage	V _{DD}	-0.3 V		7.0 V	V _{SS} =0 V
Input Voltage	V _{IN}	-0.3 V		V _{DD} +0.3 V	V _{SS} =0 V
Storage Temperature	T _{STG}	-40 °C		+85 °C	

■ Operating Condition

Item	Symbol	Specifications			Remarks
		Min.	Typ.	Max.	
Operating Voltage	V _{DD}	2.7 V	3.0 V	3.3 V	V _{SS} =0 V
Operating Temperature	T _{OPR}	-20 °C		+80 °C	
Output Current	I _{VO}	0		±100 μA	

■ Electrical Characteristics

Item	Symbol	Specifications			Remarks
		Min.	Typ.	Max.	
Drive Frequency	fd		46.5 kHz 50.3 kHz		
Sensitivity	S ₀		0.67 mV/deg/s		V _{DD} =3.0 V, T _a =+25 °C
Sensitivity Deviation	S _p			±5 %	T _a =+25 °C
Temp.Characteristic of Sensitivity	S _{pt}			±5 %	Based +25 °C, V _{DD} =3.0 V
Output (at Angular Velocity=0)	V _O	V _r -50 mV	V _r	V _r +50 mV	T _a =+25 °C
Reference Voltage	V _r	1320 mV	1350 mV	1380 mV	T _a =+25 °C
Maximum Angular Velocity	I	-100 deg/s		+100 deg/s	
Linearity	NI			±5 % FS	T _a =+25 °C
Phase Delay	Φ ₂₀		4 (Degree)		at 20Hz phase delay angle
Frequency Response	BW		200 Hz		phase delay angle 90 °
Output Noise	r _N			20 mV p-p	Using EPSON circuit
Cross Axis Sensitivity	CS			±5 %	T _a =+25 °C
Power Consumption	Generally	I _{OP}	1.7 mA		V _O , V _r : Output No load condition
	Sleep Mode	I _{SLEEP}	1 mA		V _O , V _r : Output No load condition
Startup Time	T _{STA}		240 ms		V _O , V _r : Output No load condition

■ External Dimensions (Unit:mm)

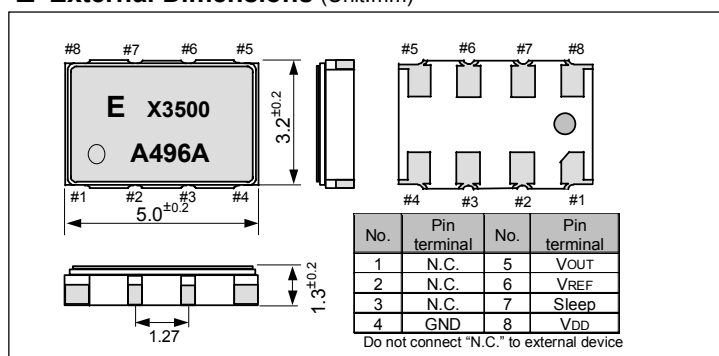

■ Recommended Soldering Pattern (Unit:mm)

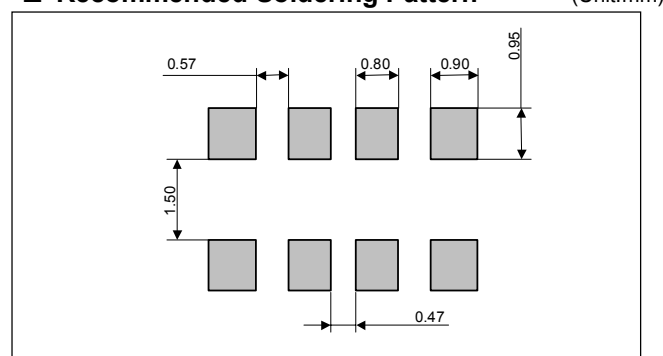

TEMPERATURE SENSING CRYSTAL

HTS - 206

Product number (please contact us)
Q19HT2060xxxx00

- Crystal used to sense the change in temperature.
- 2 mm in diameter and 6 mm in length.
- Good linearity frequency and temperature.
- Low frequency (40 kHz) enables low current consumption.
- Wide temperature range (-40 °C to +85 °C).
- Suitable for DTCXO and temperature equipment.
- Complies with EU RoHS directive.

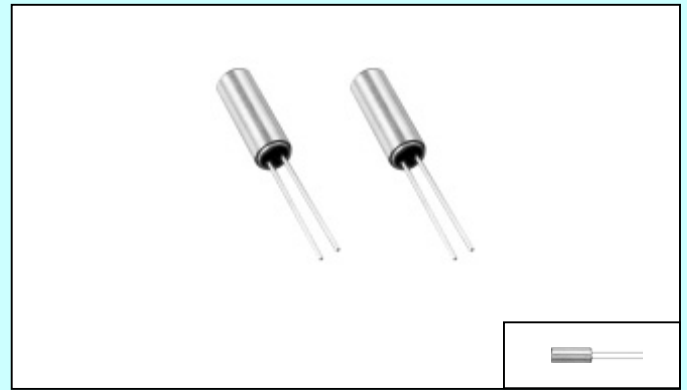

Actual Size

■ Specifications (characteristics)

Item	Symbol	Specifications	Remarks
Nominal frequency range	f	40 kHz	
Temperature range	Storage temperature	T _{STG}	-55 °C to +125 °C
	Operating temperature	T _{OPR}	-40 °C to +85 °C
Maximum drive level	GL	1.0 μW Max.	
Recommended drive level	DL	0.1 μW Typ.	
Frequency tolerance	Δf/f	±2 %	T _a =+25 °C, DL=0.1 μW
1st. Temperature coefficient	α	-26.0 × 10 ⁻⁶ / °C (±2 %)	
2nd. Temperature coefficient	β	-5.8 × 10 ⁻⁸ / °C ² (±8 %)	
3rd. Temperature coefficient	γ	-1.5 × 10 ⁻¹⁰ / °C ³ Max.	
Series resistance	R ₁	30 kΩ Max.	T _a =+25 °C, DL=0.1 μW
Motion capacitance	C ₁	2.0 fF Typ.	
Shunt capacitance	C ₀	0.9 pF Typ.	
Insulation resistance		500 MΩ Min.	
Aging	fa	± 3 × 10 ⁻⁶ / year Max.	T _a =+25 °C±3 °C
Shock resistance	S.R.	± 3 × 10 ⁻⁶ Max.	Three drops on a hard board from 500 mm

■ External dimensions

(Unit:mm)

■ Frequency Temperature characteristic

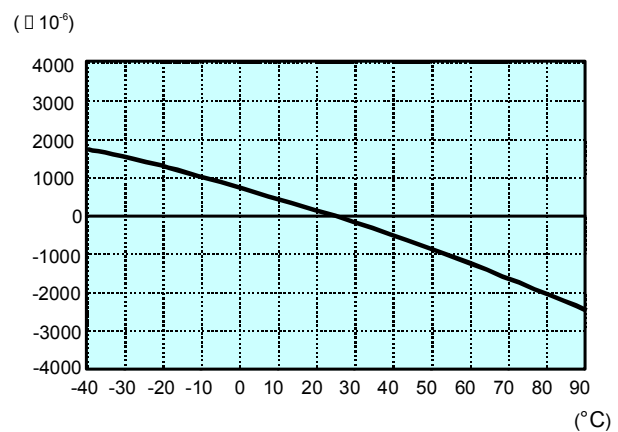
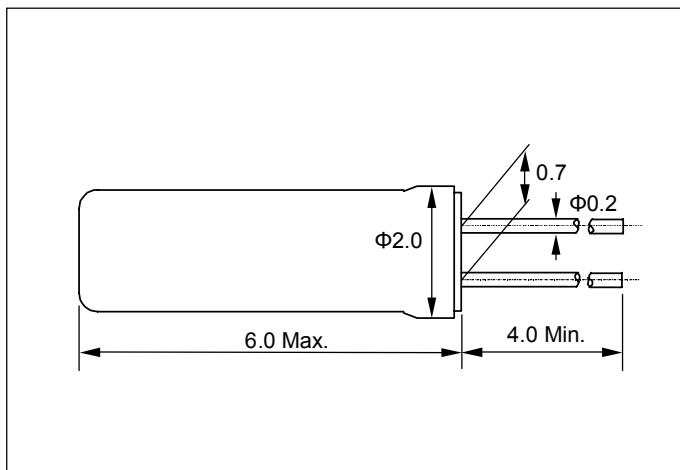

STANDARD PACKING SPECIFICATIONS

The last 2 digits of Product Number "00" means standard packing specifications. The other packing specifications are custom, therefore, the last 2 digits of Product Number is changed. Please contact us for inquiries. For SMD products, standard packing quantity is specified as below table. Please order in accordance with packing quantity.

1. Cylinder

Cylinder products are packed in vinyl bags per lot of 250 to 1000pcs.

From 1 to 20 bags are then placed in inner boxes to make a lot.

Inner boxes are then placed in cartons for shipment. (the quantity varies with the model.)

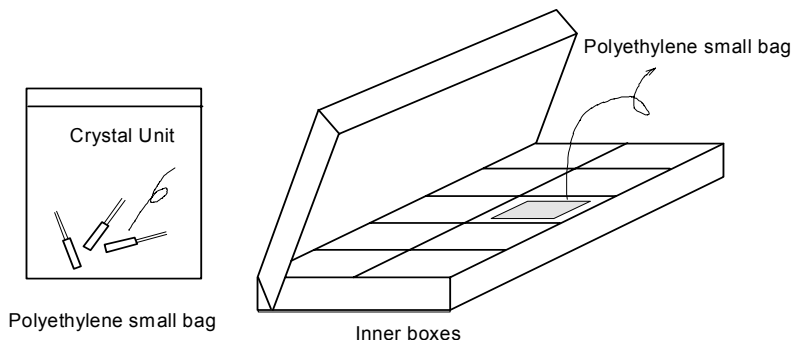

Model	Quantity
C-001R	250 pcs / vinyl bags
C-2-TYPE C-4-TYPE C-002RX C-004R C-005R CA-301	500 pcs / vinyl bags

2. DIP

DIP products are placed into antistatic IC tubes and packed into boxes for shipment.

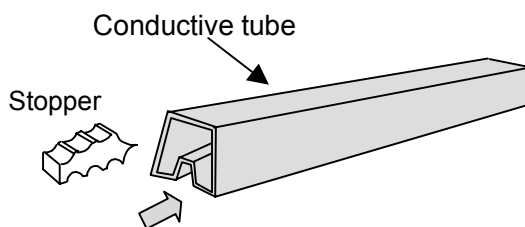

Model	Quantity
SG-531 SG-8002DC	35 pcs / tube
SG-51 SG-8002DB RTC-62421 RTC-72421 RTC-7301DG	25 pcs / tube

3. SMD

SMD products are packed in the shipping carton as below table in accordance with taping standards EIA-481A and EIAJ RC-1009B.

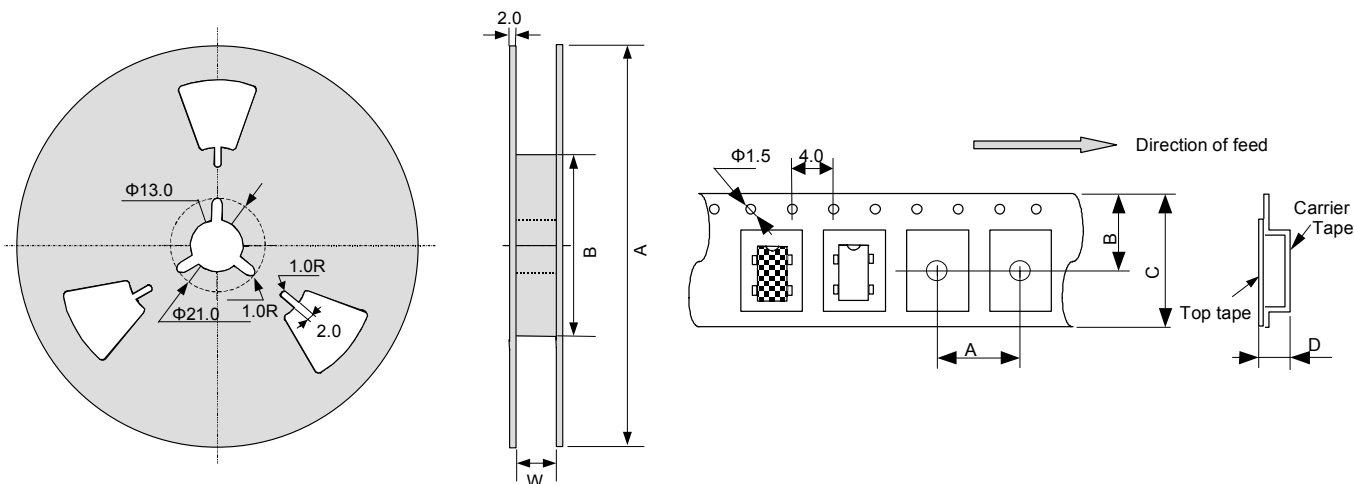

STANDARD PACKING QUANTITY and dimension (Unit:mm)

Crystal Unit/Resonator

Model	Quantity (pcs/Reel)	Reel dimension			Carrier Tape dimension				Tape type (L=left direction)
		A	B	W	A	B	C	D	
FC-135	3000	Ø180	Ø60	13.0	4.0	7.25	12.0	1.0	TE1204L
FC-145	3000	Ø180	Ø60	13.0	4.0	7.25	12.0	1.0	TE1204L
FC-255	3000	Ø330	Ø80 or Ø100	13.5	8.0	7.25	12.0	1.1	TE1208L
FA-238V/238/23H	3000	Ø180	Ø60	9.0	4.0	5.25	8.0	1.05	TE0804L
FA-365	1000	Ø180	Ø60	13.0	8.0	7.25	12.0	1.6	TE1208L
MC-146	3000	Ø330	Ø80 or Ø100	17.5	8.0	9.25	16.0	1.7	TE1608L
MC-156	3000	Ø330	Ø80 or Ø100	17.5	8.0	9.25	16.0	1.65	TE1608L
MC-306/30A	3000	Ø330	Ø80 or Ø100	17.5	8.0	9.25	16.0	3.0	TE1608L
MC-405/406	1000	Ø330	Ø80 or Ø100	17.5	8.0	9.25	16.0	3.9	TE1608L
MA-306	3000	Ø330	Ø80 or Ø100	17.5	8.0	9.25	16.0	3.0	TE1608L
MA-406	1000	Ø330	Ø80 or Ø100	25.5	12.0	13.25	24.0	4.0	TE2412L
MA-505/506	1000	Ø330	Ø80 or Ø100	25.5	12.0	13.25	24.0	4.8	TE2412L
NS-32R	4000	Ø330	Ø80 or Ø100	13.5	8.0	7.25	12.0	1.52	TE1208R
FS-335	4000	Ø330	Ø80 or Ø100	13.5	8.0	7.25	12.0	1.52	TE1208R
FS-555	4000	Ø330	Ø80 or Ø100	13.5	8.0	7.25	12.0	2.0	TE1208R
FS-585	4000	Ø330	Ø80 or Ø100	13.5	8.0	7.25	12.0	2.0	TE1208R

Crystal Oscillator

Model	Quantity (pcs/reel)	Reel dimension			Career Tape dimension				Tape type (L=left direction)
		A	B	W	A	B	C	D	
SG-3030/3032/3040JC	1000	Ø330	Ø80 or Ø100	17.5	8.0	9.25	16.0	3.3	TE1608L
SG-3030JF	1000	Ø254	Ø100	17.5	8.0	9.25	16.0	2.3	TE1608L
SG-3030/3040LC	2000	Ø180	Ø60	13.0	4.0	7.25	12.0	1.45	TE1204L
SG-350 Series	2000	Ø180	Ø60	13.0	4.0	3.10	8.0	1.5	TE0804L
SG-550 Series	2000	Ø254	Ø100	13.4	8.0	7.50	12.0	1.4	TE1208L
SG-310 Series	2000	Ø180	Ø60	9.0	4.0	5.25	8.0	1.4	TE0804L
SG-645 Series	1000	Ø254	Ø100	17.5	8.0	9.25	16.0	2.3	TE1608L
SG-710 Series	2000	Ø254	Ø80	17.5	8.0	9.25	16.0	2.5	TE1608L
SG-636 Series	1000	Ø330	Ø80 or Ø100	17.5	8.0	9.25	16.0	3.3	TE1608L
SG-615 Series	1000	Ø330	Ø80 or Ø100	25.5	12.0	13.25	24.0	4.8	TE2412L
SG-8002LA	2000	Ø180	Ø60	13.0	4.0	3.10	8.0	1.5	TE0804L
SG-8002LB	2000	Ø254	Ø100	13.4	8.0	7.50	12.0	1.4	TE1208L
SG-8002CE	2000	Ø180	Ø60	9.0	4.0	5.25	8.0	1.4	TE0804L
SG-8002JF	1000	Ø254	Ø100	17.5	8.0	9.25	16.0	2.3	TE1608L
SG-8002CA	1000	Ø254	Ø100	17.5	8.0	9.25	16.0	2.3	TE1608L
SG-8002JC	1000	Ø330	Ø80 or Ø100	17.5	8.0	9.25	16.0	3.3	TE1608L
SG-8002JA	1000	Ø330	Ø80 or Ø100	25.5	12.0	13.25	24.0	4.8	TE2412L
SG-9001CA	1000	Ø254	Ø100	17.5	8.0	9.25	16.0	2.3	TE1608L
SG-9001JC	1000	Ø330	Ø80 or Ø100	17.5	8.0	9.25	16.0	3.3	TE1608L
XG-1000CA	1000	Ø254	Ø100	17.5	8.0	9.25	16.0	2.3	TE1608L
XG-1000CB	2000	Ø254	Ø100	13.4	8.0	7.25	12.0	1.95	TE1208L
EG-2011CA	1000	Ø254	Ø100	17.5	8.0	9.25	16.0	2.3	TE1608L
EG-2021CA	1000	Ø254	Ø100	17.5	8.0	9.25	16.0	2.3	TE1608L
EG-2121CA	1000	Ø254	Ø100	17.5	8.0	9.25	16.0	2.3	TE1608L
EG-2102CA	1000	Ø254	Ø100	17.5	8.0	9.25	16.0	2.3	TE1608L
EG-2101CA	1000	Ø254	Ø100	17.5	8.0	9.25	16.0	2.3	TE1608L
EG-2002CA	1000	Ø254	Ø100	17.5	8.0	9.25	16.0	2.3	TE1608L
EG-2001CA	1000	Ø254	Ø100	17.5	8.0	9.25	16.0	2.3	TE1608L
HG-2150CA	1000	Ø254	Ø100	17.5	8.0	9.25	16.0	2.3	TE1608L
HG-8002JA	1000	Ø330	Ø80 or Ø100	25.5	12.0	13.25	24.0	4.8	TE2412L
VG-1201CA	1000	Ø254	Ø100	17.5	8.0	9.25	16.0	2.3	TE1608L
VG-4231CA	1000	Ø254	Ø100	17.5	8.0	9.25	16.0	2.3	TE1608L
VG-4030JA	1000	Ø330	Ø80 or Ø100	25.5	12.0	13.25	24.0	4.8	TE2412L
VG-2828CB	2000	Ø254	Ø100	13.4	8.0	7.25	12.0	1.95	TE1208L
TG-5001LA	2000	Ø180	Ø60	13.0	4.0	3.10	8.0	1.5	TE0804L
MG-5020JE	1000	Ø330	Ø80 or Ø100	17.5	12.0	9.25	16.0	2.0	TE1612L
MG-5100SA	1000	Ø330	Ø80 or Ø100	17.5	12.0	9.25	16.0	3.65	TE1612L

Real time clock module

RX-4045SA	1000	Ø330	Ø80 or Ø100	17.5	12.0	9.25	16.0	3.65	TE1612L
RX-4045NB	1000	Ø330	Ø80 or Ø100	17.5	12.0	9.25	16.0	1.8	TE1612L
RX-4581NB	1000	Ø330	Ø80 or Ø100	17.5	12.0	9.25	16.0	1.8	TE1612L
RTC-9701JE	1000	Ø330	Ø80 or Ø100	17.5	12.0	9.25	16.0	2.0	TE1612L
RTC-4701JE	1000	Ø330	Ø80 or Ø100	17.5	12.0	9.25	16.0	2.0	TE1612L
RTC-4701NB	1000	Ø330	Ø80 or Ø100	17.5	12.0	9.25	16.0	1.8	TE1612L
RTC-4574SA	1000	Ø330	Ø80 or Ø100	17.5	12.0	9.25	16.0	3.65	TE1612L
RTC-4574JE	1000	Ø330	Ø80 or Ø100	17.5	12.0	9.25	16.0	2.0	TE1612L
RTC-4574NB	1000	Ø330	Ø80 or Ø100	17.5	12.0	9.25	16.0	1.8	TE1612L
RX-4574LC	2000	Ø180	Ø60	13.0	4.0	7.25	12.0	1.45	TE1204L
RTC-4543SA	1000	Ø330	Ø80 or Ø100	17.5	12.0	9.25	16.0	3.65	TE1612L
RTC-4543SB	1000	Ø330	Ø80 or Ø100	24.4	12.0	11.50	24.0	2.5	TE2412L
RX-8025SA	1000	Ø330	Ø80 or Ø100	17.5	12.0	9.25	16.0	3.65	TE1612L
RX-8025NB	1000	Ø330	Ø80 or Ø100	17.5	12.0	9.25	16.0	1.8	TE1612L
RX-8581SA	1000	Ø330	Ø80 or Ø100	17.5	12.0	9.25	16.0	3.65	TE1612L
RX-8581JE	1000	Ø330	Ø80 or Ø100	17.5	12.0	9.25	16.0	2.0	TE1612L
RX-8581NB	1000	Ø330	Ø80 or Ø100	17.5	12.0	9.25	16.0	1.8	TE1612L
RTC-8564JE	1000	Ø330	Ø80 or Ø100	17.5	12.0	9.25	16.0	2.0	TE1612L
RTC-8564NB	1000	Ø330	Ø80 or Ø100	17.5	12.0	9.25	16.0	1.8	TE1612L
RX-8564LC	2000	Ø180	Ø60	13.0	4.0	7.25	12.0	1.45	TE1204L
RTC-7301SF	1000	Ø330	Ø80 or Ø100	17.5	12.0	9.25	16.0	2.4	TE1612L
RTC-62423	1000	Ø330	Ø80 or Ø100	25.5	16.0	13.25	24.0	2.95	TE2416L
RTC-72423	1000	Ø330	Ø80 or Ø100	25.5	16.0	13.25	24.0	2.95	TE2416L

Filter

FF-32N	4000	Ø330	Ø80 or Ø100	13.5	8.0	7.25	12.0	1.52	TE1208R
FF-555	4000	Ø330	Ø80 or Ø100	13.5	8.0	7.25	12.0	2.0	TE1208R
FF-585	4000	Ø330	Ø80 or Ø100	13.5	8.0	7.25	12.0	2.0	TE1208R

■COMPARISON TABLE FOR MODEL AND PRODUCT NUMBER

The Product Number expresses the specification of the product with the codes of 15 column.
As for the order, please use the Product Number.

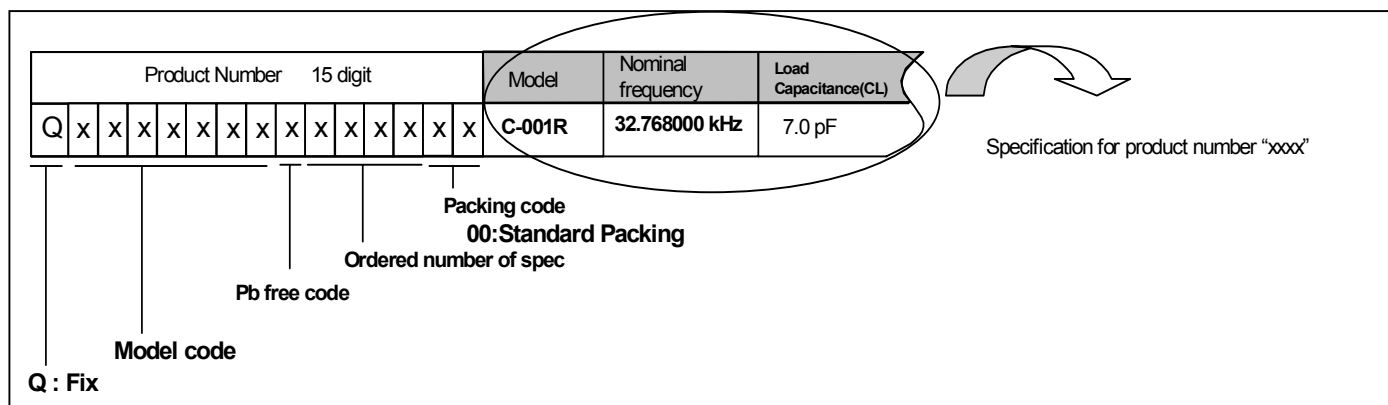

When ordering, please specify Product Number. Please confirm your specifications and consult our standard packing specifications before contacting us for a Product Number specifications and standard packing specifications.

See below for examples of our standard frequency specifications.

■CRYSTAL UNIT

●Low/ Medium- frequency (kHz range) Crystal Unit

Product number	Model	Nominal frequency	Load capacitance (CL)	Frequency tolerance ($\times 10^{-6}$)	Operating temperature range	Standard packing
Q11C001R1002100	C-001R	32.768 kHz	12.5 pF	± 20	-10°C to +60°C	250 pcs / Vinyl bags
Q11C02RX1002200	C-002RX	32.768 kHz	12.5 pF	± 20	-10°C to +60°C	500 pcs / Vinyl bags
Q11C004R0002000	C-004R	32.768 kHz	8.7 pF	± 20	-10°C to +60°C	500 pcs / Vinyl bags
Q11C005R0000200	C-005R	32.768 kHz	8.2 pF	± 30	-10°C to +60°C	500 pcs / Vinyl bags
Q13FC1350000400	FC-135	32.768 kHz	12.5 pF	± 20	-40°C to +85°C	3000 pcs / Reel "L"
Q13FC1450000600	FC-145	32.768 kHz	12.5 pF	± 20	-40°C to +85°C	3000 pcs / Reel "L"
Q13FC2550000400	FC-255	32.768 kHz	12.5 pF	± 20	-40°C to +85°C	3000 pcs / Reel "L"
Q13MC1461000200	MC-146	32.768 kHz	12.5 pF	± 20	-40°C to +85°C	3000 pcs / Reel "L"
Q13MC1561000400	MC-156	32.768 kHz	12.5 pF	± 20	-40°C to +85°C	3000 pcs / Reel "L"
Q13MC3061000300	MC-306	32.768 kHz	12.5 pF	± 20	-40°C to +85°C	3000 pcs / Reel "L"
Q13MC4051000200	MC-405	32.768 kHz	12.5 pF	± 20	-40°C to +85°C	1000 pcs / Reel "L"
Q13MC4061000100	MC-406	32.768 kHz	12.5 pF	± 20	-40°C to +85°C	1000 pcs / Reel "L"
Q12C20001025400	C-2-TYPE	40.000 kHz	12.5 pF	± 50	-10°C to +60°C	500 pcs / Vinyl bags
Q12C40000001000	C-4-TYPE	40.000 kHz	12.5 pF	± 50	-10°C to +60°C	500 pcs / Vinyl bags

●High- frequency (MHz range) Crystal Oscillator

Product Number	Model	Nominal Frequency	Load capacitance (CL)	Frequency tolerance ($\times 10^{-6}$)	Frequency temperature characteristics ($\times 10^{-6}$)	Overtone order	Standard packing
Q21CA3011052900	CA-301	20.000 MHz	16.0 pF	± 30	$\pm 30 / -20^\circ\text{C to } +70^\circ\text{C}$	Fundamental	500 pcs / Vinyl bags
Q21CA3011086200	CA-301	32.000 MHz	10.0 pF	± 30	$\pm 30 / -20^\circ\text{C to } +70^\circ\text{C}$	3rd overtone	500 pcs / Vinyl bags
Q22MA4061056300	MA-406	20.000 MHz	10.0 pF	± 50	$\pm 30 / -20^\circ\text{C to } +70^\circ\text{C}$	Fundamental	1000 pcs / Reel "L"
Q22MA4061079000	MA-406	32.000 MHz	16.0 pF	± 50	$\pm 30 / -20^\circ\text{C to } +70^\circ\text{C}$	3rd overtone	1000 pcs / Reel "L"
Q22MA3061002200	MA-306	20.000 MHz	10.0 pF	± 50	$\pm 30 / -20^\circ\text{C to } +70^\circ\text{C}$	Fundamental	3000 pcs / Reel "L"
Q22MA3061013900	MA-306	32.000 MHz	10.0 pF	± 50	$\pm 30 / -20^\circ\text{C to } +70^\circ\text{C}$	Fundamental	3000 pcs / Reel "L"
Q22FA3650006500	FA-365	20.000 MHz	10.0 pF	± 50	$\pm 30 / -20^\circ\text{C to } +70^\circ\text{C}$	Fundamental	1000 pcs / Reel "L"
Q22FA3650038600	FA-365	32.000 MHz	10.0 pF	± 50	$\pm 30 / -20^\circ\text{C to } +70^\circ\text{C}$	Fundamental	1000 pcs / Reel "L"
Q22FA2380026400	FA-238	20.000 MHz	10.0 pF	± 50	$\pm 30 / -20^\circ\text{C to } +70^\circ\text{C}$	Fundamental	3000 pcs / Reel "L"
Q22FA2380014100	FA-238	32.000 MHz	10.0 pF	± 50	$\pm 30 / -20^\circ\text{C to } +70^\circ\text{C}$	Fundamental	3000 pcs / Reel "L"

●SAW Resonator

Product Number	Model	Nominal frequency	Frequency tolerance ($\times 10^{-6}$)	Operating temperature range	Standard packing
Q25NS32R0000100	NS-32R	314.890 MHz	± 50	-40 °C to +85 °C	4000 pcs / Reel "R"
Q25FS3350005200	FS-335	315.000 MHz	± 100	-40 °C to +85 °C	4000 pcs / Reel "R"
Q25FS5550001600	FS-555	315.000 MHz	± 100	-40 °C to +85 °C	4000 pcs / Reel "R"
Q25FS5850001500	FS-585	434.000 MHz	± 50	-40 °C to +120 °C	4000 pcs / Reel "R"

■ CRYSTAL OSCILLATOR

● Low/Medium frequency

Product Number	Model	Output frequency	Frequency tolerance ($\times 10^{-6}$)	Frequency temperature characteristics	Standard packing
Q3102JF01000100	SG-3030JF	32.768 kHz	5 \pm 23	+5 to -20/-20°C to +70°C	1000 pcs / Reel "L"
Q3102JC01000100	SG-3030JC	32.768 kHz	5 \pm 23	+5 to -20/-20°C to +70°C	1000 pcs / Reel "L"
Q3101JC01000100	SG-3032JC	32.768 kHz	5 \pm 23	+5 to -20/-20°C to +70°C	1000 pcs / Reel "L"

● High-frequency (Ex: 20MHz)

Product Number	Model	Output frequency	Function	Operating Voltage	Frequency stability / Operating temperature range ($\times 10^{-6}$)	Standard packing	Suffix
Q33350F71004300	SG-350	20.000 MHz	S:Standby	C:3.3V	M: $\pm 100/-40^\circ\text{C}$ to $+85^\circ\text{C}$	2000 pcs / Reel "L"	SCF
Q33310F70001700	SG-310	20.000 MHz	S:Standby	C:3.3V	C: $\pm 100/-20^\circ\text{C}$ to $+70^\circ\text{C}$	2000 pcs / Reel "L"	SCF
Q33550FE1000800	SG-550	20.000 MHz	S:Standby	E:1.8V	B: $\pm 50/-20^\circ\text{C}$ to $+70^\circ\text{C}$	2000 pcs / Reel "L"	SEF
Q32510011000200	SG-51P	20.000 MHz	P:OE	5.0V	C: $\pm 100/-20^\circ\text{C}$ to $+70^\circ\text{C}$	25 pcs / Tube	PC
Q32531011035500	SG-531P	20.000 MHz	P:OE	5.0V	C: $\pm 100/-20^\circ\text{C}$ to $+70^\circ\text{C}$	35 pcs / Tube	PC
Q33615011077200	SG-615P	20.000 MHz	P:OE	5.0V	C: $\pm 100/-20^\circ\text{C}$ to $+70^\circ\text{C}$	1000 pcs / Reel "L"	PC
Q33636E41000900	SG-636	20.000 MHz	P:OE	C:3.3V	C: $\pm 100/-20^\circ\text{C}$ to $+70^\circ\text{C}$	1000 pcs / Reel "L"	PCE
Q33710K80001600	SG-710	20.000 MHz	OE	C:3.3V	C: $\pm 100/-20^\circ\text{C}$ to $+70^\circ\text{C}$	2000 pcs / Reel "L"	ECK
Q3324LA21000600	SG-8002LA	20.000 MHz	P:OE	H:5.0V	C: $\pm 100/-20^\circ\text{C}$ to $+70^\circ\text{C}$	2000 pcs / Reel "L"	PHC
Q3323LB21000400	SG-8002LB	20.000 MHz	P:OE	H:5.0V	C: $\pm 100/-20^\circ\text{C}$ to $+70^\circ\text{C}$	2000 pcs / Reel "L"	PHC
Q3308JF71004700	SG-8002JF	20.000 MHz	S:Standby	C:3.3V	C: $\pm 100/-20^\circ\text{C}$ to $+70^\circ\text{C}$	1000 pcs / Reel "L"	SCC
Q3309CA70006200	SG-8002CA	20.000 MHz	S:Standby	C:3.3V	C: $\pm 100/-20^\circ\text{C}$ to $+70^\circ\text{C}$	1000 pcs / Reel "L"	SCC
Q3321CE70004100	SG-8002CE	20.000 MHz	S:Standby	C:3.3V	C: $\pm 100/-20^\circ\text{C}$ to $+70^\circ\text{C}$	2000 pcs / Reel "L"	SCC
Q3307JC71000300	SG-8002JC	20.000 MHz	S:Standby	C:3.3V	C: $\pm 100/-20^\circ\text{C}$ to $+70^\circ\text{C}$	1000 pcs / Reel "L"	SCC
Q3306JA71010300	SG-8002JA	20.000 MHz	S:Standby	C:3.3V	C: $\pm 100/-20^\circ\text{C}$ to $+70^\circ\text{C}$	1000 pcs / Reel "L"	SCC
Q3203DB71000100	SG-8002DB	20.000 MHz	S:Standby	C:3.3V	C: $\pm 100/-20^\circ\text{C}$ to $+70^\circ\text{C}$	25 pcs / Tube	SCC
Q3204DC71000300	SG-8002DC	20.000 MHz	S:Standby	C:3.3V	C: $\pm 100/-20^\circ\text{C}$ to $+70^\circ\text{C}$	35 pcs / Tube	SCC

● Low jitter

Product Number	Model	Output frequency	Output	Operating voltage	Frequency stability ($\times 10^{-6}$)	Consistence	Standard packing	Suffix
Q3807CA00000100	EG-2021CA	125.000 MHz	C:CMOS	2.5V	GP: $\pm 50/0^\circ\text{C}$ to $+70^\circ\text{C}$	N	1000 pcs / Reel "L"	CGPN
Q3801CA00000200	EG-2001CA	125.000 MHz	P:(CMOS)	C:3.3V	H: $\pm 100/0^\circ\text{C}$ to $+70^\circ\text{C}$	—	1000 pcs / Reel "L"	PCH
Q3802CA00000200	EG-2002CA	125.000 MHz	P:(LV-TTL)	C:3.3V	Z: $\pm 50/0^\circ\text{C}$ to $+70^\circ\text{C}$	—	1000 pcs / Reel "L"	PCZ
Q3805CA00000200	EG-2121CA	125.000 MHz	P:LV-PECL	2.5V	HP: $\pm 100/0^\circ\text{C}$ to $+70^\circ\text{C}$	A	1000 pcs / Reel "L"	PHPA
Q3805CA10000300	EG-2121CA	125.000 MHz	L:LVDS	2.5V	HP: $\pm 100/0^\circ\text{C}$ to $+70^\circ\text{C}$	A	1000 pcs / Reel "L"	LHPA
Q3806CA000002900	EG-2102CA	125.000 MHz	P:LV-PECL	3.3V	HP: $\pm 100/0^\circ\text{C}$ to $+70^\circ\text{C}$	A	1000 pcs / Reel "L"	PHPA
Q3806CA100003900	EG-2102CA	125.000 MHz	L:LVDS	3.3V	HP: $\pm 100/0^\circ\text{C}$ to $+70^\circ\text{C}$	A	1000 pcs / Reel "L"	LHPA
Q3803CA000002300	EG-2101CA	125.000 MHz	D:(LV-PECL)	C:3.3V	H: $\pm 100/0^\circ\text{C}$ to $+70^\circ\text{C}$	—	1000 pcs / Reel "L"	DCH

● High-stability

Product Number	Model	Output frequency	Frequency stability ($\times 10^{-6}$)	Function	Operating voltage	Standard packing	Suffix
Q3514CA000001900	HG-2150CA	20.000 MHz	BX: $\pm 25/-40^\circ\text{C}$ to $+85^\circ\text{C}$	OE	C:3.3V	1000 pcs / Reel "L"	BXC
Q3502JA71005400	HG-8002JA	20.000 MHz	BV: $\pm 25/-20^\circ\text{C}$ to $+70^\circ\text{C}$	S:Standby	C:3.3V	1000 pcs / Reel "L"	SCBV

● Spread spectrum

Product Number	Model	Output frequency	Modulation type	Spread percentage	Function	Standard packing	Suffix
Q33317010001600	SG-9001CA	100.000 MHz	C:Centre	15: $\pm 1.5\%$	P:OE	1000 pcs / Reel "L"	C15P
Q3331E111000700	SG-9001JC	100.000 MHz	D:Down	20:-2.0%	P:OE	1000 pcs / Reel "L"	D20P

● Voltage Control (VCXO)

Product Number	Model	Output frequency	Frequency stability ($\times 10^{-6}$)	Pull range	Operating voltage	Standard packing	Suffix
Q3603CA000004300	VG-1201CA	27.000 MHz	B: $\pm 25/-40^\circ\text{C}$ to $+85^\circ\text{C}$	N: ± 100	C:3.3V	1000 pcs / Reel "L"	BNC-F
Q3614CA00101800	VG-4231CA	27.000 MHz	G: $\pm 50/-40^\circ\text{C}$ to $+85^\circ\text{C}$	R: ± 130	C:3.3V	1000 pcs / Reel "L"	GRC-F
Q3612JA01000100	VG-4030JA	27.000 MHz	$\pm 37/-20^\circ\text{C}$ to $+70^\circ\text{C}$	± 150	C:3.3V	1000 pcs / Reel "L"	DVK

■ TEMPERATURE SENSING CRYSTAL

Product Number	Model	Nominal frequency	Frequency tolerance	Operating temperature range	Standard packing
Q19HT2060000100	HTS-206	40.000 kHz	±2%	-10 °C to +60 °C	500 pcs / Vinyl bags



■ SAW FILTER

Product Number	Model	Nominal frequency	Pass bandwidth	Insertion loss	Operating temperature range	Standard packing
Q51FF32N0000100	FF-32N	429.450 MHz	f _N ±300 kHz Min	3.5 dB Max.	-10°C~+60°C	4000 pcs / Reel "R"
Q51FF5550000700	FF-555	315.000 MHz	f _N ±100 kHz Min.	3.5 dB Max.	-40°C~+85°C	4000 pcs / Reel "R"
Q51FF5850000300	FF-585	315.000 MHz	f _N ±200 kHz Min.	3.5 dB Max.	-40°C~+85°C	4000 pcs / Reel "R"

■ REAL TIME CLOCK MODULE

Product Number	Model	Frequency tolerance (×10 ⁻⁶)	Standard packing
Q41404551000100	RX-4045SA	AA: 5±5	1000 pcs / Reel "L"
Q41404591000100	RX-4045NB	AA: 5±5	1000 pcs / Reel "L"
Q41458191000200	RX-4581NB	B : 5±23	1000 pcs / Reel "L"
Q41970171000100	RTC-9701JE	B : 5±23	1000 pcs / Reel "L"
Q41470191000200	RTC-4701NB	B : 5±23	1000 pcs / Reel "L"
Q41457451000200	RTC-4574SA	B : 5±23	1000 pcs / Reel "L"
Q41457471000100	RTC-4574JE	B : 5±23	1000 pcs / Reel "L"
Q41457491000100	RTC-4574NB	B : 5±23	1000 pcs / Reel "L"
Q41454351000200	RTC-4543SA	B : 5±23	1000 pcs / Reel "L"
Q41454361000200	RTC-4543SB	B : 5±23	1000 pcs / Reel "L"
Q41802551000100	RX-8025SA	AA: 5±5	1000 pcs / Reel "L"
Q41802591000100	RX-8025NB	AA: 5±5	1000 pcs / Reel "L"
Q41858151000200	RX-8581SA	B : 5±23	1000 pcs / Reel "L"
Q41858171000200	RX-8581JE	B : 5±23	1000 pcs / Reel "L"
Q41858191000200	RX-8581NB	B : 5±23	1000 pcs / Reel "L"
Q41856471000100	RTC-8564JE	B : 5±23	1000 pcs / Reel "L"
Q41856491000200	RTC-8564NB	B : 5±23	1000 pcs / Reel "L"
Q42730181000200	RTC-7301SF	B : 5±23	1000 pcs / Reel "L"
Q42730111000200	RTC-7301DG	B : 5±23	1000 pcs / Reel "L"
Q42624211000200	RTC-62421	A: ±10	25 pcs / Tube
Q42624231000200	RTC-62423	A: ±20	1000 pcs / Reel "L"
Q42724211000100	RTC-72421	A: ±10	25 pcs / Tube
Q42724231000600	RTC-72423	A: ±20	1000 pcs / Reel "L"

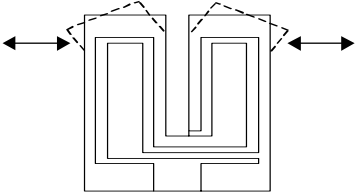
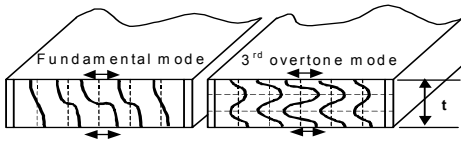
Glossary

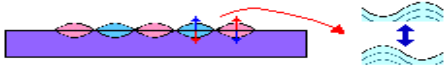
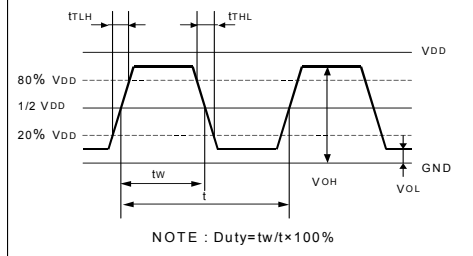
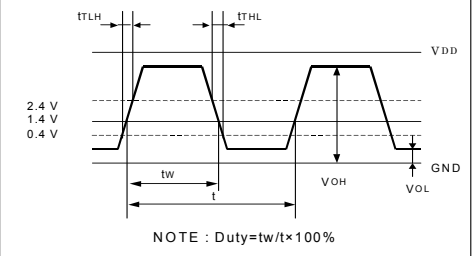
Item	Content	Object
Fundamental mode	<p>First harmonic crystal vibration mode. The AT resonance frequency is determined by the thickness of the crystal, but even with the same thickness the Third overtone will be about three times the frequency of the fundamental. With tuning fork crystal unit, the second overtone is about six times the fundamental.</p> <div style="display: flex; justify-content: space-around;"> <div style="text-align: center;"> <p>Tuning fork crystal unit Fundamental mode</p>  </div> <div style="text-align: center;"> <p>AT-cut crystal unit</p> $F(\text{MHz}) = \frac{1670}{t(\mu\text{m})} \quad (t: \text{Thickness})$  </div> </div> <div style="display: flex; justify-content: space-around; margin-top: 10px;"> <div style="text-align: center;"> <p>SAW Resonator</p>  <p>SAW Structure figure</p> </div> <div style="text-align: center;">  <p>Vibration mode</p> </div> </div> <p>Output Frequency $f = k/\lambda$ (λ=Interval of an/the electrode, k = Fixed number)</p>	X'tal ,OSC
Divided frequency	The output frequency that is divided by the internal IC.	OSC
Duty (tw/t) (symmetry)	<p>Ratio of full and half cycles. For CMOS loading duty is rated at 1/2 V_{DD}, and for TTL loading at 1.4V.</p> <div style="display: flex; justify-content: space-around;"> <div style="text-align: center;"> <p>● CMOS loading</p>  <p>NOTE : Duty=tw/t×100%</p> </div> <div style="text-align: center;"> <p>● TTL loading</p>  <p>NOTE : Duty=tw/t×100%</p> </div> </div>	OSC
(Equivalent)series capacitance (C ₁) (motional capacitance)	Energy distortion to the (equivalent) internal charge capacitance component of the crystal unit, at the series resonant frequency.	X'tal
(Equivalent)series resonant resistance (R ₁)	Vibration loss to the (equivalent) internal charge capacitance component of the crystal unit, at the series resonant frequency. A measure of the easiness of oscillation.	X'tal
Drive level (DL)	Current or voltage level in the oscillating (operating)state.(Drive power= power required to oscillate crystal unit.)	X'tal
Frequency (f)	Number of waves (cycles)per second. The relation between frequency and cycle is f(Hz)=1/t(s).	ALL
(Frequency)aging (fa)	Amount of frequency drift when operated under the specified conditions for a specified term.	ALL
Frequency tolerance precision (Δf/f)	Under specified conditions at an ambient temperature of +25 °C,the difference in actual (measured) frequency from the nominal frequency.	X'tal ,RTCM
Frequency stability (Δf/fo)	Within standard temperature and operational voltage ranges, the drift in the output frequency. The output frequency drift including frequency temperature characteristics and frequency voltage characteristics.	OSC

X'tal:Crystal unit, OSC:Crystal oscillator, RTCM:Real time clock module

More details available on Epson website.

http://www.epsondevice.com/qd_e

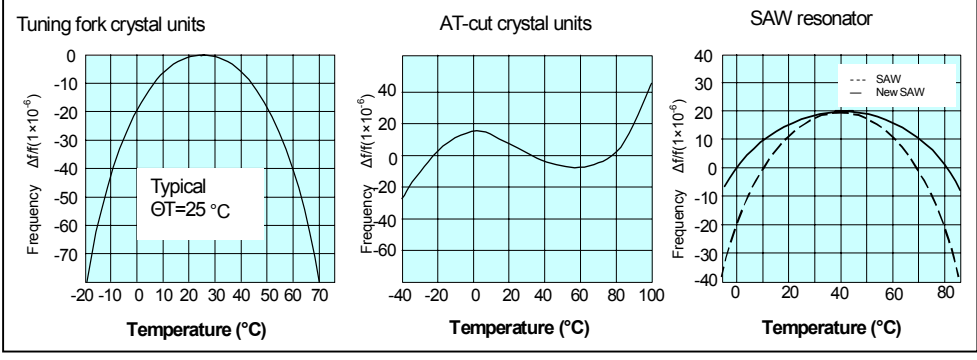
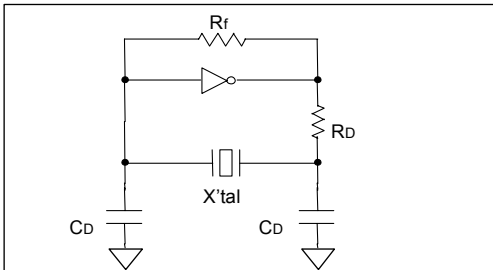
Item	Content	Object
Frequency temperature characteristics	<p>Taking the frequency at 25 degrees Centigrade as the reference, the change in frequency in response to ambient temperature.</p> <ul style="list-style-type: none"> ● Tuning fork crystal unit. SAW Resonator. $\Delta f/f = a(\Theta T - \Theta X)^2$ $\Theta X: \text{specified temperature}$ ● AT crystal unit. $\Delta f/f = \alpha(\Theta X - 25) + \beta(\Theta X - 25)^2 + \gamma(\Theta X - 25)^3$ <p>Examples of frequency temperature characteristics</p> 	ALL
Frequency voltage Characteristics	<p>Taking the output frequency at the central voltage in the operating voltage range as the reference, the change in output frequency to voltage. Causes of this change are changes in crystal deformation, and changes in IC internal constants for chips mounted in the oscillator and Real time clock module. The effects of the ICs are larger.</p>	OSC, RTCm
Insulation resistance(IR)	Resistance between lead and lead, or between lead and case package.(conductive package)	ALL
Load capacitance(CL)	Effective capacitance (series equivalent charge capacitance) of the oscillation circuit as seen from the pins of the crystal unit. This capacitance is determined as a condition when the crystal unit is connected to the oscillation circuit and will determine the output frequency. Load capacitance approximation:CL	X'tal
Max.drive level (GL)	Rating for the drive level. Current or power input over this level may result in characteristic degradation or destruction.	X'tal
Max supply voltage (VDD-GND)	Maximum rated value for power input to the power supply pin. Input over this value may result in characteristic degradation or destruction.	OSC, RTCm
Nominal frequency(f)	Nominal value of frequency of crystal unit.	X'tal
Operating temperature Range(TOPR)	Temperature range where specification characteristics are fulfilled, unless otherwise specified.	ALL
Operation voltage (VDD)	Voltage input to VDD pin which will support continuous operation with specification characteristics.	OSC, RTCm
Origin frequency (f ₀)	Oscillation source frequency of oscillator inside oscillation system.	OSC
Oscillation circuit	<p>Circuit needed to oscillate crystal unit. Circuit Constants will differ with type of crystal unit and frequency.</p> <p style="text-align: center;">Basic oscillation circuit using CMOS IC</p> 	X'tal

X'tal:Crystal Unit, OSC:Crystal Oscillator, RTCm:Real time clock module

More details available on Epson website.

http://www.epsondevice.com/qd_e

Item	Content	Object
Oscillation Start up time (t _{osc})	The time from power on until the wave form stabilizes. However, voltage rise times depend on the power supply. Therefore, the time depends on the power supply, and the time is measured from a specific set of initial conditions.	OSC,RTCm
Output enable(OE)	Output is switched to high impedance, and wired OR connection can be used to select multiple outputs(frequency). OE pin: High or open. Specified frequency output = enabled. OE pin: Low. Output is high impedance=disabled. Oscillation is not stopped, so after the clock is disabled, it is not synchronized with OE (clock is continuous).	OSC
Output fall time(t _{FHL})	The time it takes for the output wave form to change from the high voltage(high level) to the low voltage(low level). Also called wave form fall time. See wave form diagram under Duty.	OSC
Output frequency(f _o)	The frequency output from the oscillator circuit or the crystal oscillator system.	OSC,RTCm
Output load conditions (N or CL)	The types and quantities (power) of the loads that can be connected to the oscillator. Calculated for 1 TTL as I _{OH} = -40 μA, I _{OL} = 1.6 mA and for LS-TTL as I _{OH} = -20 μA, I _{OL} = 0.4 mA.	OSC
Output rise time(t _{TLH})	The time it takes for the output wave form to change from the low voltage (low level) to the high voltage (high level). Also called wave form fall time. See wave from diagram under Duty.	OSC
Overtone	Vibration state when crystal is vibrating as a high harmonic(see base wavelength). It is harder To match the overtone oscillation circuit with the crystal unit than the fundamental oscillation circuit.	X'tal,OSC
Shunt capacitance(C _o)	Charge capacitance between the two electrodes in the crystal unit.	X'tal
Recommended drive level (DL)	Excitation level for optimum oscillation characteristics.	X'tal
Soldering conditions(T _{SOL})	Temperatures or times over these limits may result in characteristic degradation or destruction.	ALL
Stand-by (ST)	Function that halts crystal unit oscillation and frequency Division. Cuts the current consumed by the oscillators circuit and the frequency division stage. ST pin-high or open: Specified frequency output. ST pin-low: Output is low level,oscillation stops. : Output is low level (weak pull-down), oscillation stops. : Output is high impedance, oscillation stops. Please refer to each data sheet.	OSC
Shortage temperature Range(T _{stg})	Maximum absolute rating for the discharged state (no input of voltage, current or power). Exposure to temperatures over this level may result in characteristic degradation or destruction. To assure precision, store at room temperature whenever possible.	ALL

X'tal:Crystal Unit, OSC:Crystal Oscillator, RTCm:Real time clock module

More details available on Epson website.

http://www.epsondevice.com/qd_e

Electronic Device Information on WWW server

Seiko Epson is providing the Electronic Devices Information, Semiconductor, Liquid Crystal Display, Crystal Products and more. Please access here!

Seiko Epson Electronic Device Home Page

<http://www.epsondevice.com>



Quartz Device Top page

http://www.epsondevice.com/qd_e



Quartz Devices produced using
Original Technology

Click !

Lineup Page for each device



Catalog & Data Sheet Page

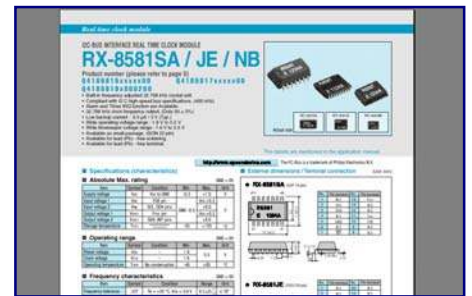

Product Inquiry by E-mail

Seiko Epson receives your inquiries on the products through e-mail. Your inquiry is welcome at Seiko Epson. Mail address : edevic@epson.co.jp

EPSON Electronic Device Product Guide

Seiko Epson sells many products other than our broad array of Crystal devices. Please inquire about our other fine products through the Seiko Epson business office.

Division	Business item
Semi conductor device	ASIC(Gate Array,Embedded Array,Standard Cell),MCU(Micro computer),LCD Controller,Driver,Interface IC,Network controller,Power supply IC,Clock IC
Display device	High temperature poly- silicon TFT (HTPS)
Optical device	Optical low pass filter (OLPF), Dichroic mirror,UV cut filter,IR cut filter, Non spherical surface lens

■Product Inquiry by E- Mail

Seiko Epson receives your inquiries on the products through e- mail. Your inquiry is welcome at Seiko Epson.

Mail address:

edevice@epson.co.jp

Manufacturing Plant

- Ina Plant
- EPM. : Epson Precision (Malaysia) SDN. BHD. Plant
- S.Z.E. : Suzhou Epson CO.,LTD.Plant
- E.P.P.I. : Epson Precision (Philippines) Inc. Plant

Plant	Date Operations Commenced	Products
Ina Plant	Jun.1959	Crystal unit Crystal oscillator Real time clock module Surface acoustic wave device
E.P.M. Plant	Dec.1974	Crystal unit Crystal oscillator Real time clock module
S.Z.E. Plant	Mar.1997	Crystal unit
E.P.P.I. Plant	Feb.2002	Crystal unit

Business area

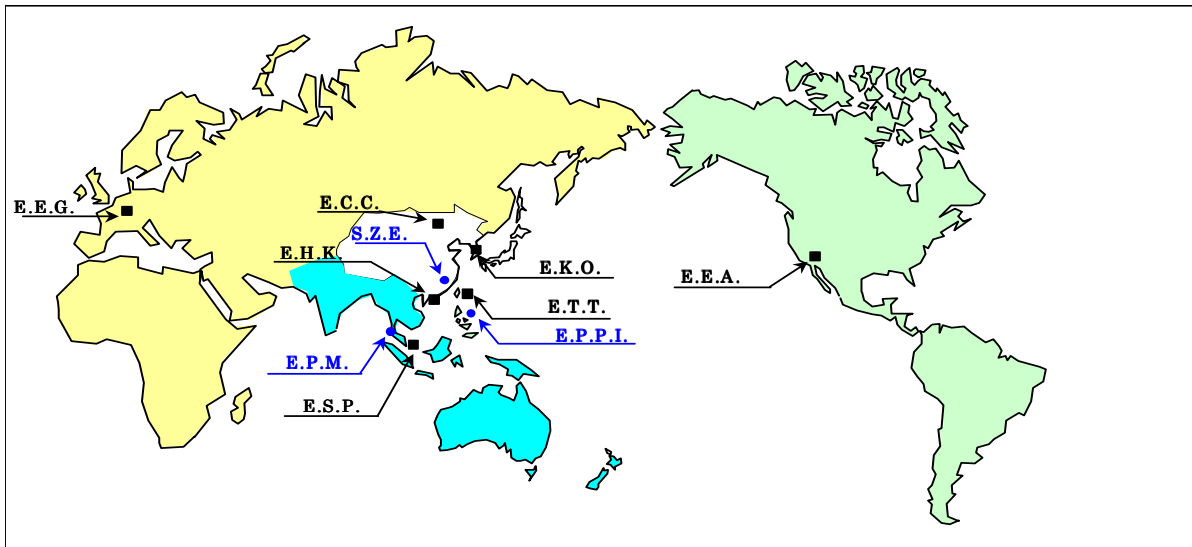

- E.E.A. : Epson Electronics America,Inc.
- E.E.G. : Epson Europe Electronics GmbH
- E.H.K. : Epson Hong Kong Ltd.
- E.T.T. : Epson Taiwan Technology & Trading Ltd.
- E.S.P. : Epson Singapore Pte.Ltd.
- E.C.C. : Epson (China) Co.,Ltd.
- E.K.O. : Seiko Epson Corp. Korea Office

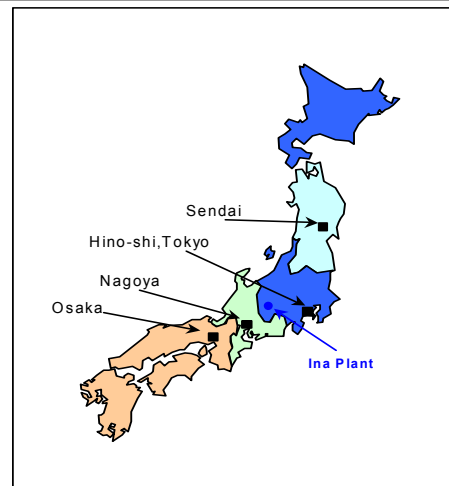

Distributor

AMERICA

EPSON ELECTRONICS AMERICA, INC.

HEADQUARTER	150 River Oaks Parkway, San Jose, CA 95134, U.S.A. Phone: (1)800-228-3964 (Toll free) : (1)408-922-0200 (Main) Fax: (1)408-922-0238 http://www.eea.epson.com
Atlanta Office	3010 Royal Blvd. South, Ste. 170, Alpharetta, GA 30005, U.S.A. Phone: (1)877-332-0020 (Toll free) : (1)770-777-2078 (Main) Fax: (1)770-777-2637
Boston Office	301Edgewater Place, Ste. 120, Wakefield, MA 01880, U.S.A. Phone: (1)800-922-7667 (Toll free) : (1)781-246-3600 (Main) Fax: (1)781-246-5443
Chicago Office	101 Virginia St., Ste. 290, Crystal Lake, IL 60014, U.S.A. Phone: (1)800-853-3588 (Toll free) : (1)815-455-7630 (Main) Fax: (1)815-455-7633
El Segundo Office	1960 E. Grand Ave., 2nd Floor, El Segundo, CA 90245, U.S.A. Phone: (1)800-249-7730 (Toll free) : (1)310-955-5300 (Main) Fax: (1)310-955-5400

EUROPE

EPSON EUROPE ELECTRONICS GmbH

HEADQUARTER	Riesstrasse 15, 80992 Munich, Germany Phone: (49)-(0)89-14005-0 Fax: (49)-(0)89-14005-110 http://www.epson-electronics.de
Düsseldorf Branch Office	Altstadtstrasse 176, 51379 Leverkusen, Germany Phone: (49)-(0)2171-5045-0 Fax: (49)-(0)2171-5045-10
UK & Ireland Branch Office	Unit 2.4, Doncastle House, Doncastle Road, Bracknell, Berkshire RG12 8PE, England Phone: (44)-(0)1344-381700 Fax: (44)-(0)1344-381701
French Branch Office	LP 915 Les Conquérants, 1 Avenue de l' Atlantique, Z.A. de Courtaboeuf 2 91976 Les Ulis Cedex, France Phone: (33)-(0)1-64862350 Fax: (33)-(0)1-64862355

ASIA

EPSON (CHINA) CO., LTD.

	23F, Beijing Silver Tower 2# North RD DongSangHuan ChaoYang District, Beijing, China Phone: (86) 10-6410-6655 Fax: (86) 10-6410-7319 http://www.epson.com.cn
Shanghai Branch	High-Tech Building,900 Yishan Road Shanghai 200233,China Phone: (86) 21-5423-5577 Fax: (86) 21-5423-4677

EPSON HONG KONG LTD.

20/F., Harbour Centre, 25 Harbour Road, Wanchai, Hong kong
Phone: (852) 2585-4600 Fax: (852) 2827-2152 <http://www.epson.com.hk>

EPSON ELECTRONIC TECHNOLOGY DEVELOPMENT (SHENZHEN) CO., LTD.

12/F, Dawning Mansion,#12 Keji South Road, Hi-Tech Park, Shenzhen, China
Phone: (86) 755-26993828 Fax: (86) 755-26993838

EPSON TAIWAN TECHNOLOGY & TRADING LTD.

14F, No.7, Song Ren Road, Taipei 110
Phone: (886) 2-8786-6688 Fax: (886)2-8786-6660 <http://www.epson.com.tw>

EPSON SINGAPORE PTE. LTD.

401, Commonwealth Drive, #07-01 Haw Par Technocentre Singapore 149598
Phone: (65) 6-586-3100 Fax: (65) 6-472-4291 <http://www.epson.com.sg>

SEIKO EPSON CORPORATION KOREA Office

	50F, KLI 63 Building,60 Yoido-dong, Youngdeungpo-Ku, Seoul, 150-763, Korea Phone: (82) 2-784-6027 Fax: (82) 2-767-3677 http://www.epson-device.co.kr
Gumi Branch Office	2F, Grand Bldg,457-4, Songjeong-dong Gumi-City, Gyongsangbuk-Do, 730-090, Korea Phone: (82) 54-454-6027 Fax: (82) 54-454-6093

THE CRYSTALMASTER May 2005

Issued on May.,2005

SEIKO EPSON CORPORATION

Quartz Devices Operations Division.



<http://www.epsondevice.com>

SEIKO EPSON CORPORATION



Printed with soy ink on recycled paper.
Document code : 710080100
Issued January 2005
Printed May 2005, in Japan ㊞