

Speaker Specification

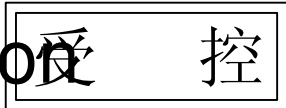

Customer's Model No.		Customer		QUARTZ-1	
Kepo Model No.		KPSP3034MN-32/0.5E -5569	Size	Φ 30mm	No. KFC5569
No.	Item	Specification	Test Condition		
1	Impedance	32Ω ± 15%	at 800Hz		
2	Resonant Fr. (f _o)	850Hz± 20%			
3	Frequency Range	F0-6.0KHz			
4	Rated Power	0.5W			
5	Max Power	0.6W			
6	S.P.L.	91± 3dB	0.1w/0.1m at AVG 0.8,1.0,1.2,1.5KHz		
7	Distortion	Max 5%	at rated power 1.0kHz		
8	Sweep Test	must be normal	at sine wave 4.0V		
9	Load Test	after test meet item 8	rated noise power, 24 Hrs.		
10	Heat Test	after test meet item 8	50± 2℃ 5Hrs.		
11	Cold Test	after test meet item 8	-20± 2℃ 5Hrs.		
12	Humidity Test	after test meet item 8	40± 2℃,90/95%R.H. 5Hrs.		
13	Weight				
14	Polarity Test	When supplied plus D.C. voltage to (+) terminal, the cone must move to forward.			
15	Note				

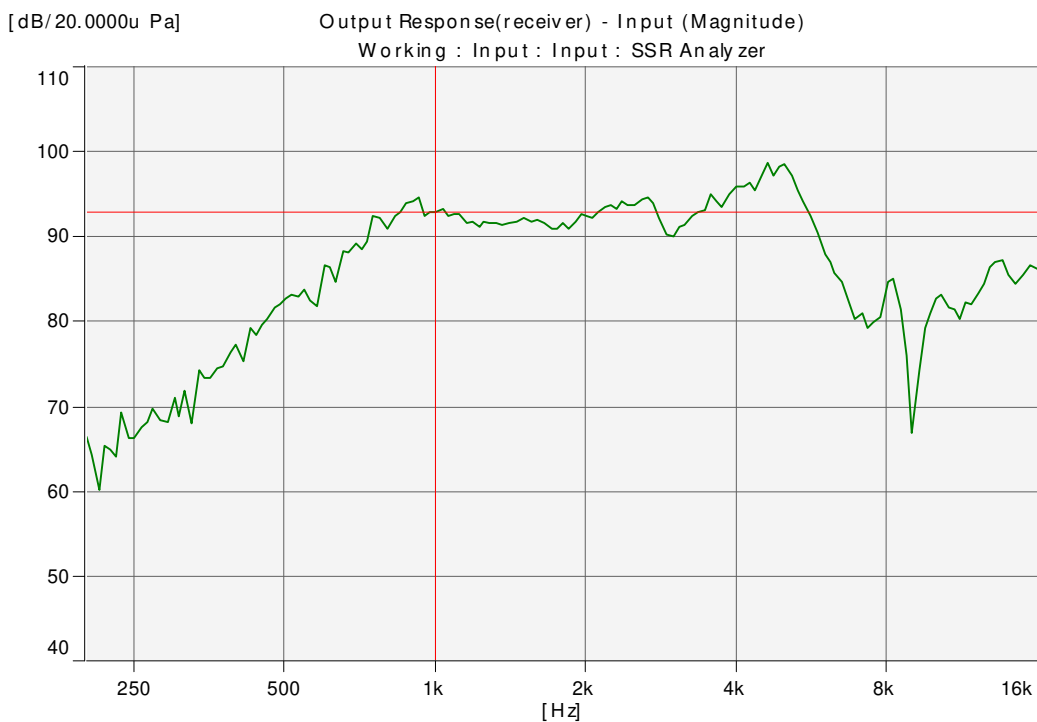

Dimensions:

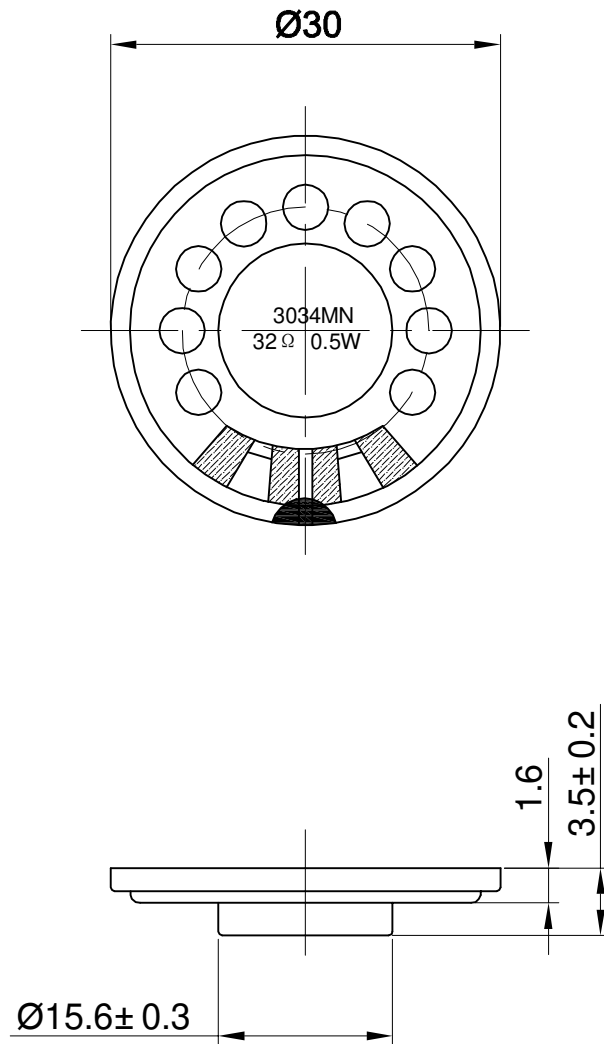

FIRST ANGLE PROJECTION

UNIT : mm
Tolerance : ± 0.2