

**MOC3061-M    MOC3062-M    MOC3063-M    MOC3162-M    MOC3163-M**

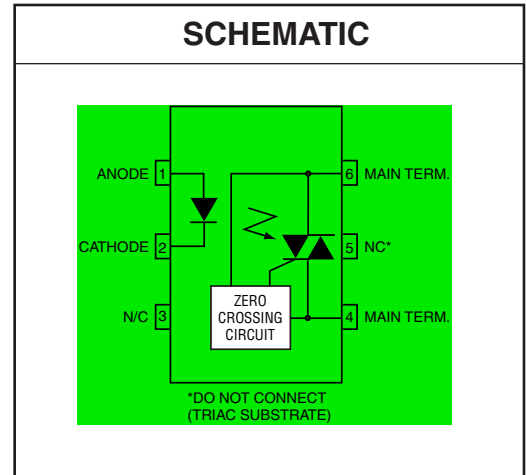
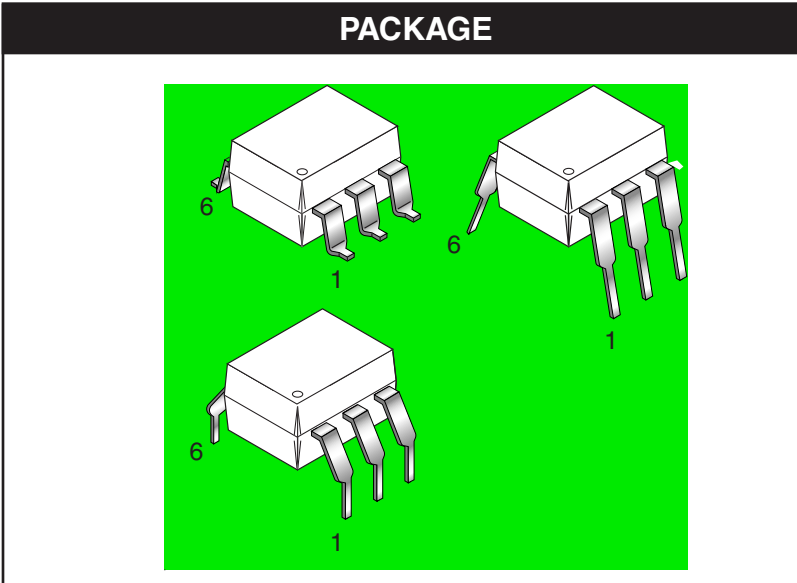

**DESCRIPTION**

The MOC306X-M and MOC316X-M devices consist of a GaAs infrared emitting diode optically coupled to a monolithic silicon detector performing the function of a zero voltage crossing bilateral triac driver. They are designed for use with a triac in the interface of logic systems to equipment powered from 115/240 VAC lines, such as solid-state relays, industrial controls, motors, solenoids and consumer appliances, etc.

**FEATURES**

- Simplifies logic control of 115/240 VAC power
- Zero voltage crossing
- dv/dt of 1000 V/μs guaranteed (MOC316X-M),  
– 600 V/μs guaranteed (MOC306X-M)
- VDE recognized (File # 94766)  
– ordering option V (e.g., MOC3063V-M)
- Underwriters Laboratories (UL) recognized (File #E90700, volume 2)

**APPLICATIONS**

- Solenoid/valve controls
- Static power switches
- Temperature controls
- AC motor starters
- Lighting controls
- AC motor drives
- E.M. contactors
- Solid state relays

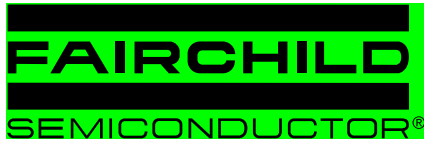

# 6-PIN DIP ZERO-CROSS PHOTOTRIAC DRIVER OPTOCOUPLER (600V PEAK)

**MOC3061-M    MOC3062-M    MOC3063-M    MOC3162-M    MOC3163-M**

<b>ABSOLUTE MAXIMUM RATINGS</b> ( $T_A = 25^\circ\text{C}$ unless otherwise noted)				
Parameters	Symbol	Device	Value	Units
<b>TOTAL DEVICE</b>				
Storage Temperature	$T_{STG}$	All	-40 to +150	$^\circ\text{C}$
Operating Temperature	$T_{OPR}$	All	-40 to +85	$^\circ\text{C}$
Lead Solder Temperature	$T_{SOL}$	All	260 for 10 sec	$^\circ\text{C}$
Junction Temperature Range	$T_J$	All	-40 to +100	$^\circ\text{C}$
Isolation Surge Voltage <sup>(4)</sup> (peak AC voltage, 60Hz, 1 sec duration)	$V_{ISO}$	All	7500	Vac(pk)
Total Device Power Dissipation @ 25 $^\circ\text{C}$ Derate above 25 $^\circ\text{C}$	$P_D$	All	250	mW
			2.94	mW/ $^\circ\text{C}$
<b>EMITTER</b>				
Continuous Forward Current	$I_F$	All	60	mA
Reverse Voltage	$V_R$	All	6	V
Total Power Dissipation 25 $^\circ\text{C}$ Ambient Derate above 25 $^\circ\text{C}$	$P_D$	All	120	mW
			1.41	mW/ $^\circ\text{C}$
<b>DETECTOR</b>				
Off-State Output Terminal Voltage	$V_{DRM}$	All	600	V
Peak Repetitive Surge Current (PW = 100 $\mu\text{s}$ , 120 pps)	$I_{TSM}$	All	1	A
Total Power Dissipation @ 25 $^\circ\text{C}$ Ambient Derate above 25 $^\circ\text{C}$	$P_D$	All	150	mW
			1.76	mW/ $^\circ\text{C}$

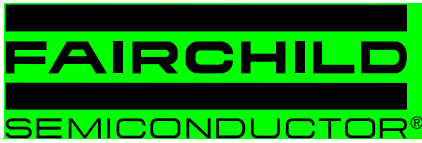

# 6-PIN DIP ZERO-CROSS PHOTOTRIAC DRIVER OPTOCOUPLER (600V PEAK)

**MOC3061-M    MOC3062-M    MOC3063-M    MOC3162-M    MOC3163-M**

## ELECTRICAL CHARACTERISTICS (T<sub>A</sub> = 25°C Unless otherwise specified)

### INDIVIDUAL COMPONENT CHARACTERISTICS

Parameters	Test Conditions	Symbol	Device	Min	Typ*	Max	Units
<b>EMITTER</b>							
Input Forward Voltage	I <sub>F</sub> = 30 mA	V <sub>F</sub>	All		1.3	1.5	V
Reverse Leakage Current	V <sub>R</sub> = 6 V	I <sub>R</sub>	All		0.005	100	μA
<b>DETECTOR</b>							
Peak Blocking Current, Either Direction	V <sub>DRM</sub> = 600V, I <sub>F</sub> = 0 (note 1)	I <sub>DRM1</sub>	MOC316X-M MOC306X-M		10 10	100 500	nA
Critical Rate of Rise of Off-State Voltage	I <sub>F</sub> = 0 (figure 9, note 3)	dv/dt	MOC306X-M MOC316X-M	600 1000	1500		V/μs

### TRANSFER CHARACTERISTICS (T<sub>A</sub> = 25°C Unless otherwise specified.)

DC Characteristics	Test Conditions	Symbol	Device	Min	Typ*	Max	Units
LED Trigger Current (rated I <sub>FT</sub> )	main terminal Voltage = 3V (note 2)	I <sub>FT</sub>	MOC3061-M MOC3062-M/ MOC3162-M MOC3063-M/ MOC3163-M			15 10 5	mA
Peak On-State Voltage, Either Direction	I <sub>TM</sub> = 100 mA peak, I <sub>F</sub> = rated I <sub>FT</sub>	V <sub>TM</sub>	All		1.8	3	V
Holding Current, Either Direction		I <sub>H</sub>	All		500		μA

### ZERO CROSSING CHARACTERISTICS

Characteristics	Test Conditions	Symbol	Device	Min	Typ*	Max	Units
Inhibit Voltage (MT1-MT2 voltage above which device will not trigger)	I <sub>F</sub> = Rated I <sub>FT</sub>	V <sub>INH</sub>	MOC3061-M/2M/3M MOC3162-M/3M		12	20 15	V
Leakage in Inhibited State	I <sub>F</sub> = Rated I <sub>FT</sub> , V <sub>DRM</sub> = 600V, off state	I <sub>DRM2</sub>	All		150	500	μA

### ISOLATION CHARACTERISTICS

Characteristics	Test Conditions	Symbol	Device	Min	Typ*	Max	Units
Isolation Voltage	f = 60 Hz, t = 1 sec	V <sub>ISO</sub>	All	7500			V

\*Typical values at T<sub>A</sub> = 25°C

#### Notes

- Test voltage must be applied within dv/dt rating.
- All devices are guaranteed to trigger at an I<sub>F</sub> value less than or equal to max I<sub>FT</sub>. Therefore, recommended operating I<sub>F</sub> lies between max I<sub>FT</sub> (15 mA for MOC3061-M, 10 mA for MOC3062-M & MOC3162-M, 5 mA for MOC3063-M & MOC3163-M) and absolute max I<sub>F</sub> (60 mA).
- This is static dv/dt. See Figure 9 for test circuit. Commutating dv/dt is a function of the load-driving thyristor(s) only.
- Isolation surge voltage, V<sub>ISO</sub>, is an internal device dielectric breakdown rating. For this test, Pins 1 and 2 are common, and Pins 4, 5 and 6 are common.

Figure 1. LED Forward Voltage vs. Forward Current

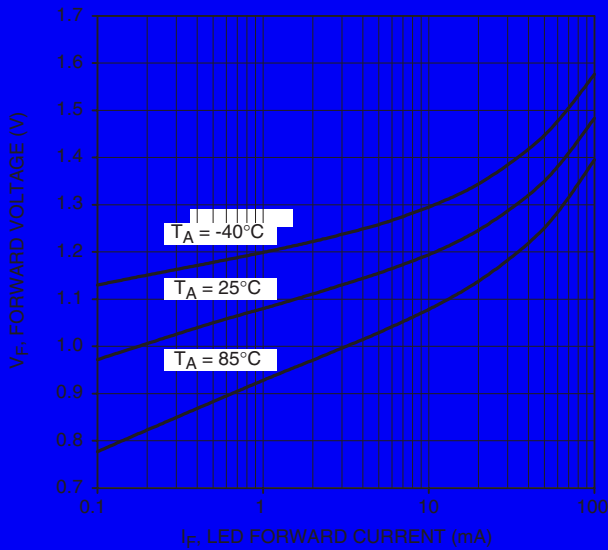

Figure 2. Trigger Current Vs. Temperature

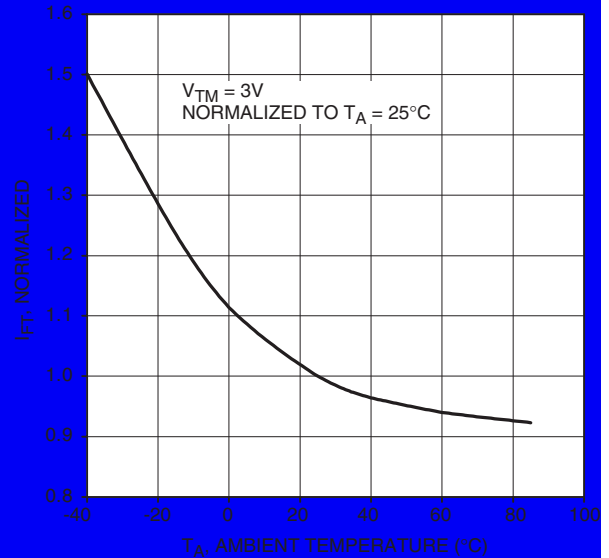

Figure 3. LED Current Required to Trigger vs. LED Pulse Width

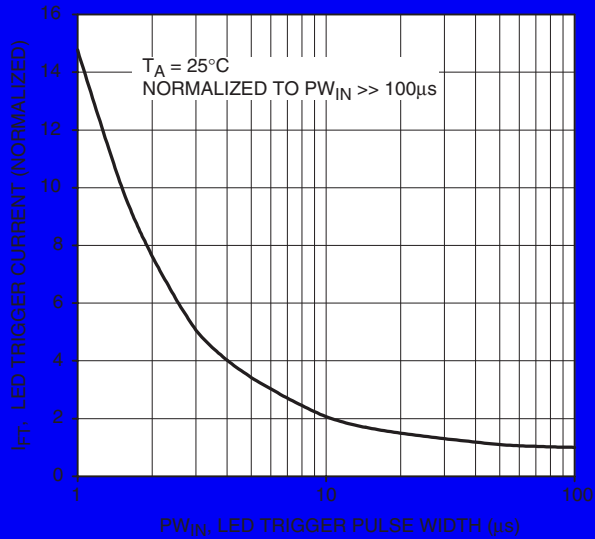

Figure 4. Leakage Current,  $I_{DRM}$  vs. Temperature

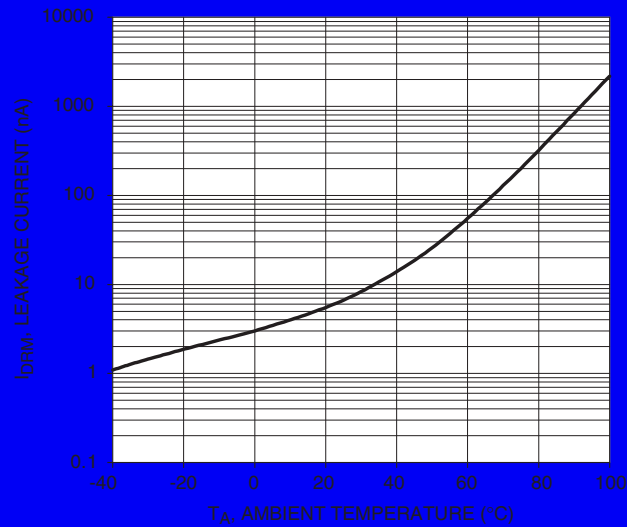

Figure 5.  $I_{DRM2}$ , Leakage in Inhibit State vs. Temperature

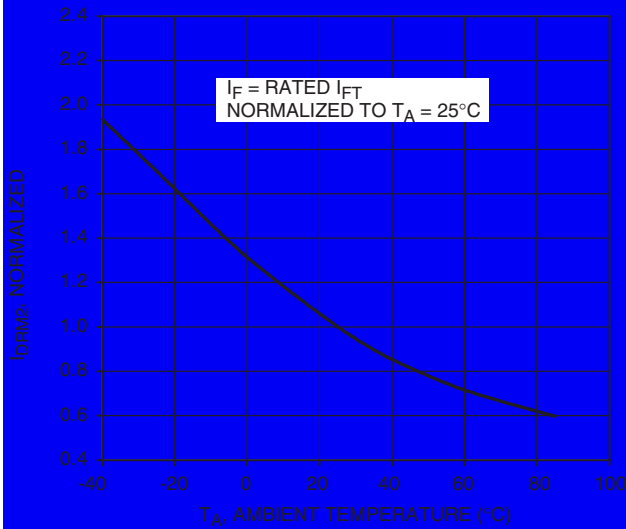

Figure 6. On-State Characteristics

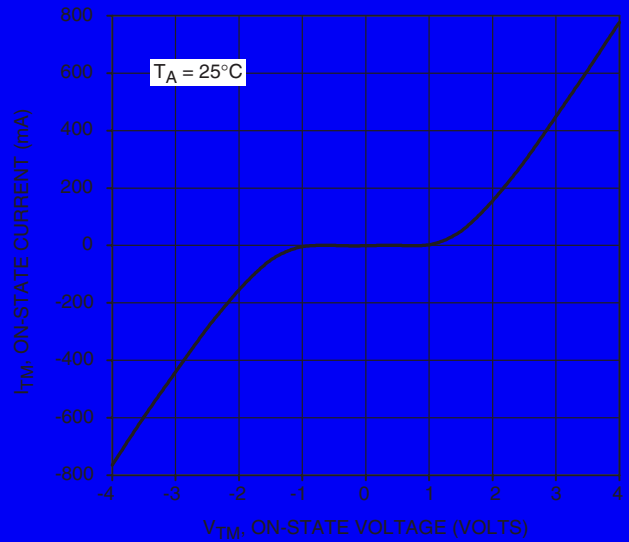

Figure 7.  $I_H$ , Holding Current vs. Temperature

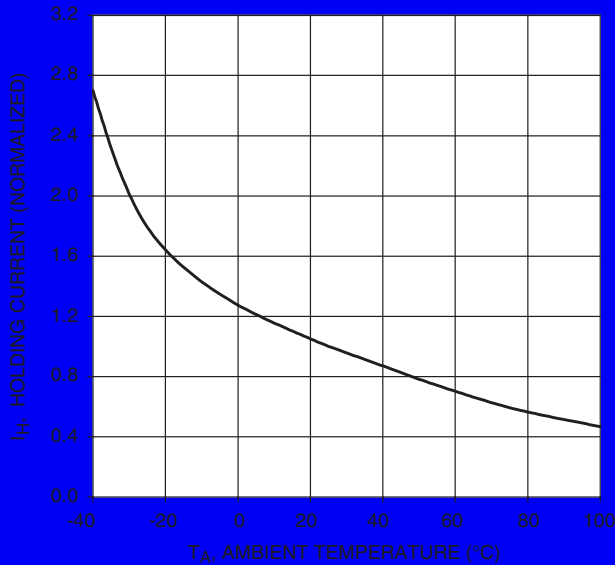
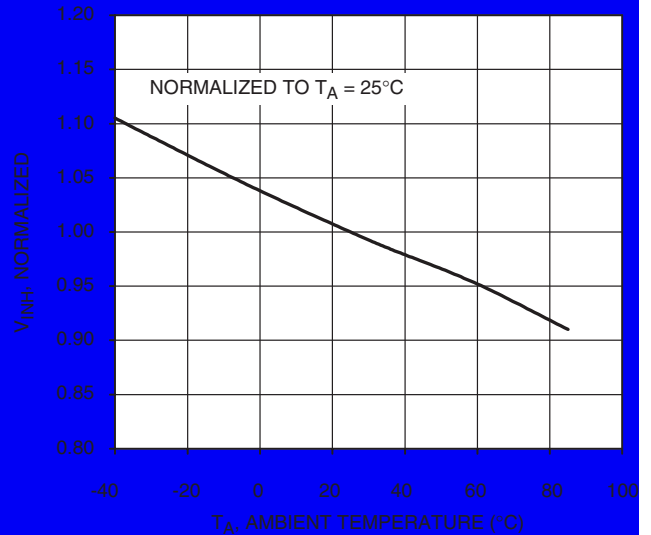
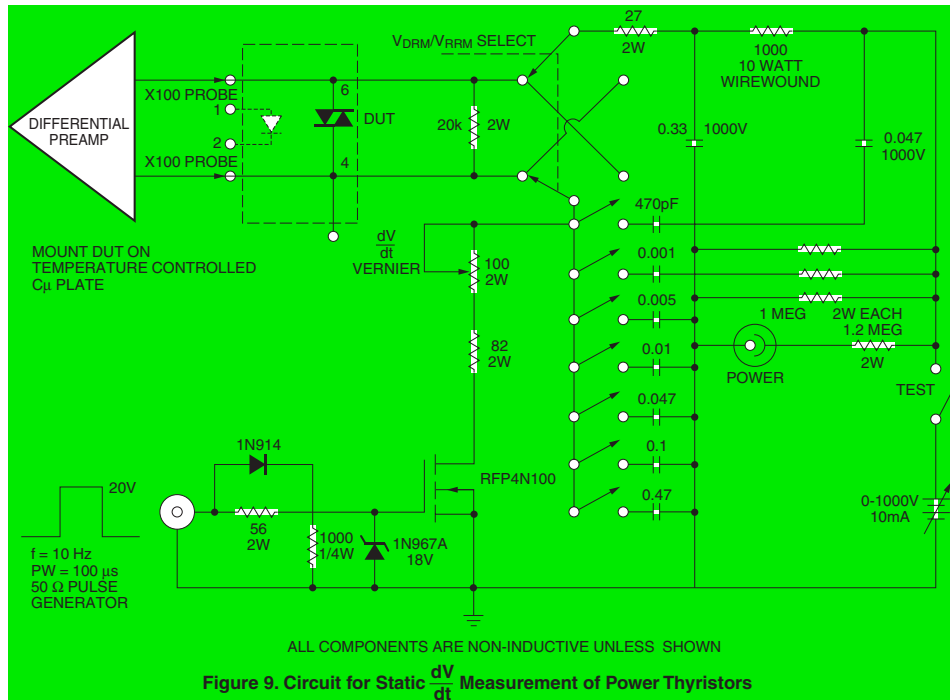

Figure 8. Inhibit Voltage vs. Temperature



**MOC3061-M    MOC3062-M    MOC3063-M    MOC3162-M    MOC3163-M**

1. 100x scope probes are used, to allow high speeds and voltages.
2. The worst-case condition for static  $dv/dt$  is established by triggering the D.U.T. with a normal LED input current, then removing the current. The variable vernier resistor combined with various capacitor combinations allows the  $dv/dt$  to be gradually increased until the D.U.T. continues to trigger in response to the applied voltage pulse, even after the LED current has been removed. The  $dv/dt$  is then decreased until the D.U.T. stops triggering.  $\tau_{RC}$  is measured at this point and recorded.



## BASIC APPLICATIONS

Typical circuit for use when hot line switching is required. In this circuit the "hot" side of the line is switched and the load connected to the cold or neutral side. The load may be connected to either the neutral or hot line.

$R_{in}$  is calculated so that  $I_F$  is equal to the rated  $I_{FT}$  of the part, 15 mA for the MOC3061-M, 10 mA for the MOC3062-M, or 5 mA for the MOC3063-M. The 39 ohm resistor and 0.01  $\mu F$  capacitor are for snubbing of the triac and is often, but not always, necessary depending upon the particular triac and load used.

Suggested method of firing two, back-to-back SCR's with a Fairchild triac driver. Diodes can be 1N4001; resistors, R1 and R2, are optional 330 ohm.

Note: This optoisolator should not be used to drive a load directly. It is intended to be a trigger device only.

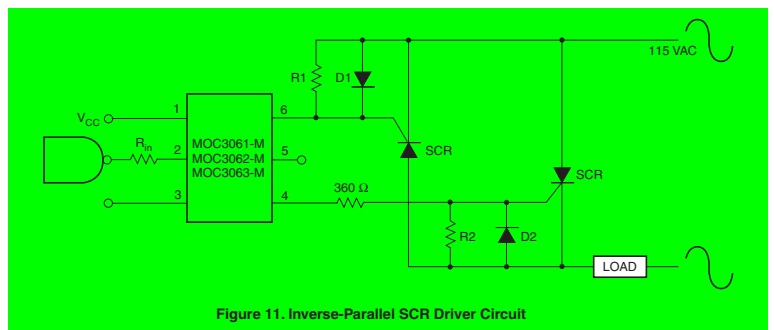
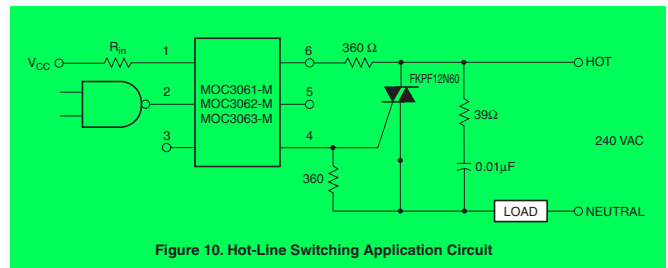

# 6-PIN DIP ZERO-CROSS PHOTOTRIAC DRIVER OPTOCOUPLER (600V PEAK)

MOC3061-M    MOC3062-M    MOC3063-M    MOC3162-M    MOC3163-M

### Package Dimensions (Through Hole)

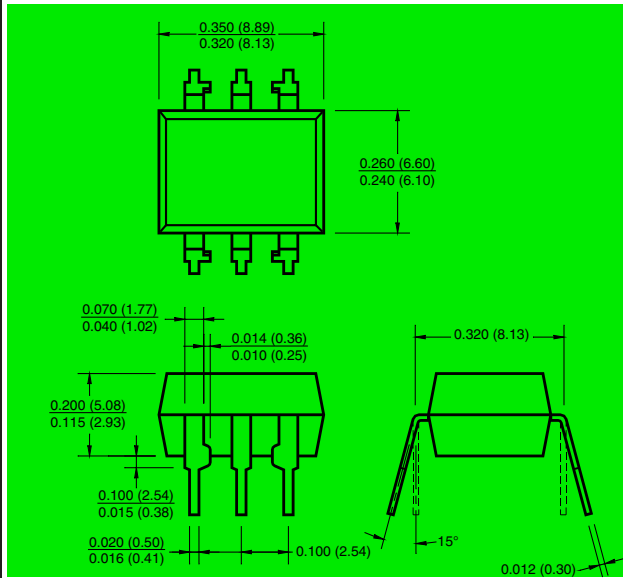

### Package Dimensions (Surface Mount)

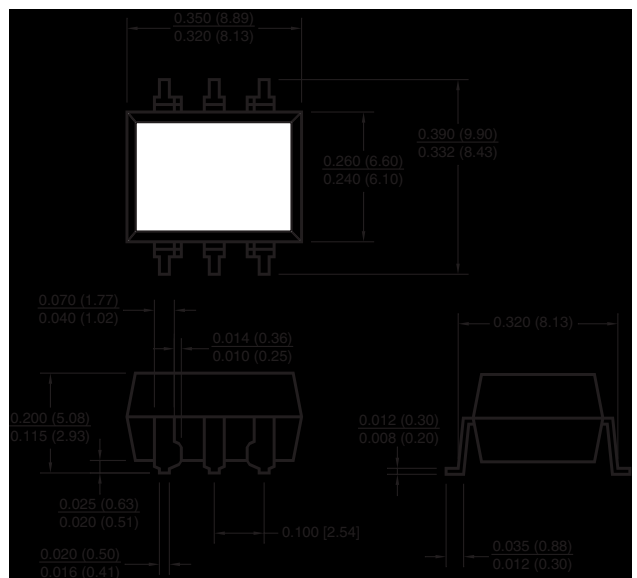

### Package Dimensions (0.4" Lead Spacing)

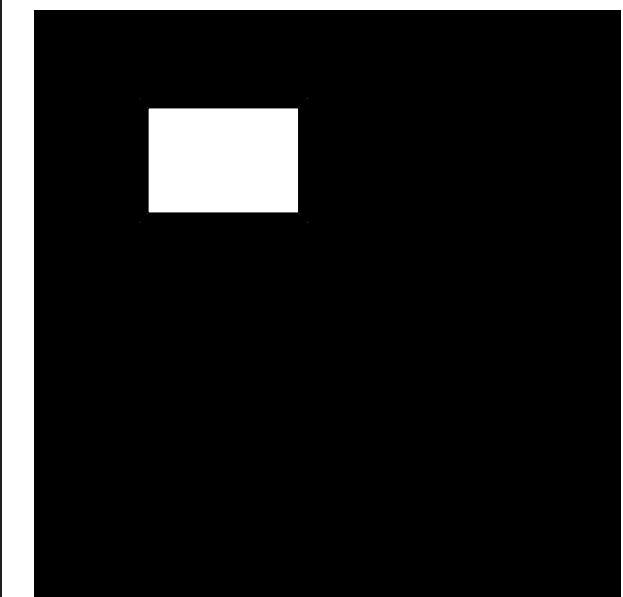

### Recommended Pad Layout for Surface Mount Leadform

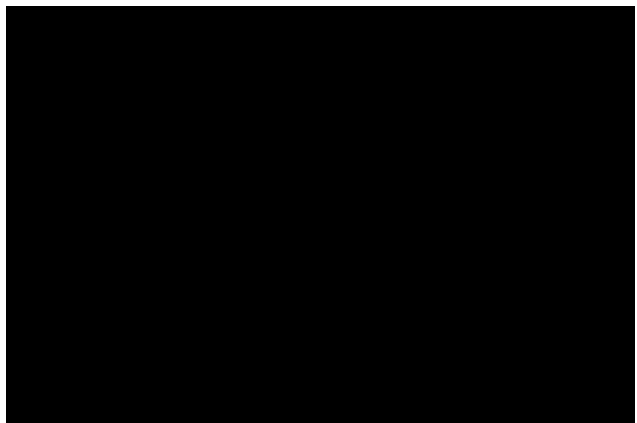

**NOTE**  
All dimensions are in inches (millimeters)

# 6-PIN DIP ZERO-CROSS PHOTOTRIAC DRIVER OPTOCOUPLER (600V PEAK)

**MOC3061-M    MOC3062-M    MOC3063-M    MOC3162-M    MOC3163-M**

## ORDERING INFORMATION

Option	Order Entry Identifier	Description
S	S	Surface Mount Lead Bend
SR2	SR2	Surface Mount; Tape and reel
T	T	0.4" Lead Spacing
V	V	VDE 0884
TV	TV	VDE 0884, 0.4" Lead Spacing
SV	SV	VDE 0884, Surface Mount
SR2V	SR2V	VDE 0884, Surface Mount, Tape & Reel

## MARKING INFORMATION

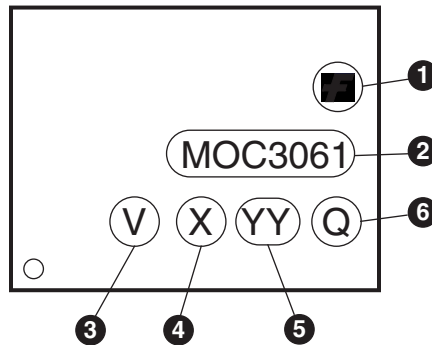

Definitions	
1	Fairchild logo
2	Device number
3	VDE mark (Note: Only appears on parts ordered with VDE option – See order entry table)
4	One digit year code, e.g., '3'
5	Two digit work week ranging from '01' to '53'
6	Assembly package code

\*Note – Parts that do not have the 'V' option (see definition 3 above) that are marked with date code '325' or earlier are marked in portrait format.



MOC3061-M MOC3062-M MOC3063-M MOC3162-M MOC3163-M

**Carrier Tape Specifications**

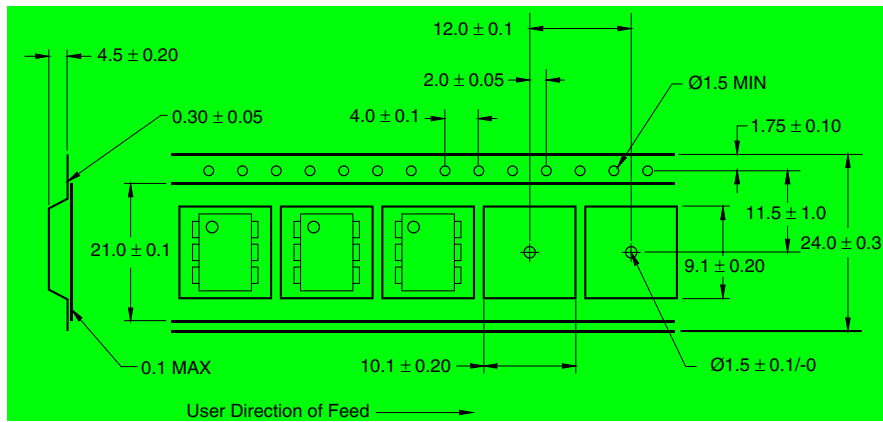

**NOTE**

All dimensions are in inches (millimeters)

**Reflow Profile (White Package, -M Suffix)**

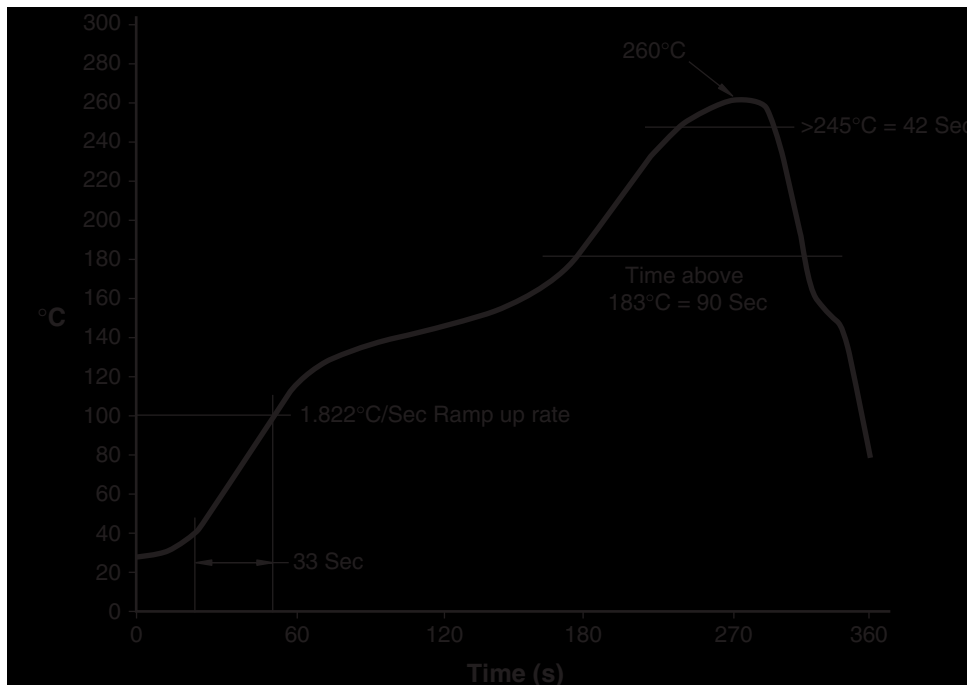

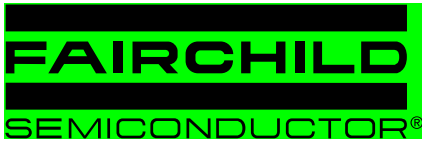

# 6-PIN DIP ZERO-CROSS PHOTOTRIAC DRIVER OPTOCOUPLER (600V PEAK)

---

**MOC3061-M    MOC3062-M    MOC3063-M    MOC3162-M    MOC3163-M**

---

## **DISCLAIMER**

FAIRCHILD SEMICONDUCTOR RESERVES THE RIGHT TO MAKE CHANGES WITHOUT FURTHER NOTICE TO ANY PRODUCTS HEREIN TO IMPROVE RELIABILITY, FUNCTION OR DESIGN. FAIRCHILD DOES NOT ASSUME ANY LIABILITY ARISING OUT OF THE APPLICATION OR USE OF ANY PRODUCT OR CIRCUIT DESCRIBED HEREIN; NEITHER DOES IT CONVEY ANY LICENSE UNDER ITS PATENT RIGHTS, NOR THE RIGHTS OF OTHERS.

## **LIFE SUPPORT POLICY**

FAIRCHILD'S PRODUCTS ARE NOT AUTHORIZED FOR USE AS CRITICAL COMPONENTS IN LIFE SUPPORT DEVICES OR SYSTEMS WITHOUT THE EXPRESS WRITTEN APPROVAL OF THE PRESIDENT OF FAIRCHILD SEMICONDUCTOR CORPORATION. As used herein:

1. Life support devices or systems are devices or systems which, (a) are intended for surgical implant into the body, or (b) support or sustain life, and (c) whose failure to perform when properly used in accordance with instructions for use provided in the labeling, can be reasonably expected to result in a significant injury of the user.
2. A critical component in any component of a life support device or system whose failure to perform can be reasonably expected to cause the failure of the life support device or system, or to affect its safety or effectiveness.