

МИНИАТЮРНЫЕ ТУМБЛЕРА СЕРИИ MTS.



Miniature Toggle Switch MTS Series



Ordering Information

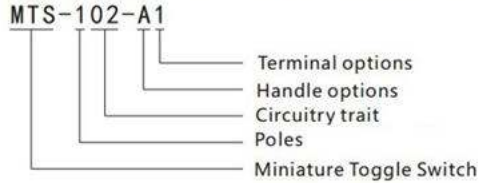

Specification

1. Rating:6A 125VAC;3A 250VAC
2. Contact Resistance:20mΩ max
3. Insulation Resistance:500VDC 1000MΩ min
4. Dielectric Strength:1500VAC ,1Minute
5. Operating Temperature:-25°C ~ +85°C
6. Electrical Life:10,000 Cycles

Circuitry trait

Model No	Circuitry trait			Type	Terminals
MTS-101	ON	—	OFF	SPST	2P
MTS-102	ON	—	ON	SPDT	3P
MTS-112	ON	—	(ON)	SPDT	3P
MTS-103	ON	OFF	ON	SPDT	3P
MTS-113	ON	OFF	(ON)	SPDT	3P
MTS-123	(ON)	OFF	(ON)	SPDT	3P

Base color

Material	Base color	
PBT	Blue	
Bakelite	Red	Black

Model No	Circuitry trait			Type	Terminals
MTS-201	ON	—	OFF	DPST	4P
MTS-202	ON	—	ON	DPDT	6P
MTS-212	ON	—	(ON)	DPDT	6P
MTS-203	ON	OFF	ON	DPDT	6P
MTS-213	ON	OFF	(ON)	DPDT	6P
MTS-223	(ON)	OFF	(ON)	DPDT	6P

Indicates Momentary

Water proof cap

Handle options

<p>Standard (A)</p>	<p>Long (B)</p>	<p>Short (C)</p>	<p>With handle cap (D)</p>	<p>Grand (G)</p> <p>1/4-40NS</p>
---------------------	-----------------	------------------	----------------------------	----------------------------------

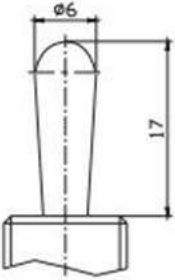
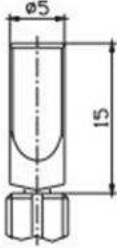
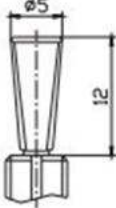
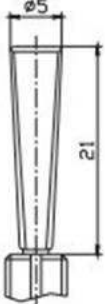
<p>Large handle (L)</p>  <p>M12X0.75</p>	<p>Plastic Flat (E)</p>  <p>1/4-40NS</p>	<p>Metal Flat (F)</p> 	<p>Long Metal Flat (FL)</p> 
---	---	--	---

Terminal options

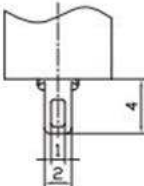
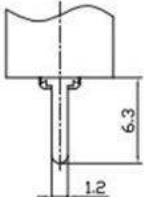
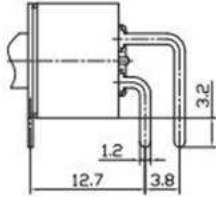
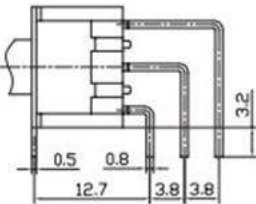
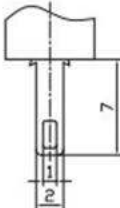
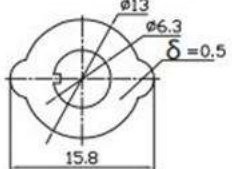
<p>Solder terminal (1)</p> 	<p>PC terminal (2)</p> 	<p>PC-H terminal (3)</p> 												
<p>PC-V terminal (4)</p> 	<p>Long Solder terminal (5)</p> 	<p>Nameplate</p>  <table border="1" data-bbox="1241 1507 1449 1597"> <tr> <td>(1)</td> <td>ON</td> <td>-</td> <td>OFF</td> </tr> <tr> <td>(2)</td> <td>ON</td> <td>-</td> <td>ON</td> </tr> <tr> <td>(3)</td> <td>ON</td> <td>OFF</td> <td>ON</td> </tr> </table>	(1)	ON	-	OFF	(2)	ON	-	ON	(3)	ON	OFF	ON
(1)	ON	-	OFF											
(2)	ON	-	ON											
(3)	ON	OFF	ON											

MTS-102-C4 ON-ON SPDT 3P

