

Miniature Rocker Switch

Q-2657

TYPE: **MRS-203A**

SPECIFICATIONS

Contact Type: DPDT
 Rating: 6A 250V AC
 Contact R: 35mΩ max
 Insulation R: 500V DC 100MΩ min
 Dielectric Strength: 1 Minute 1500V AC
 Operating Temperature: -25°C ~ +85°C
 Electrical Life: 10, 000 Cycles

Outline Drawing

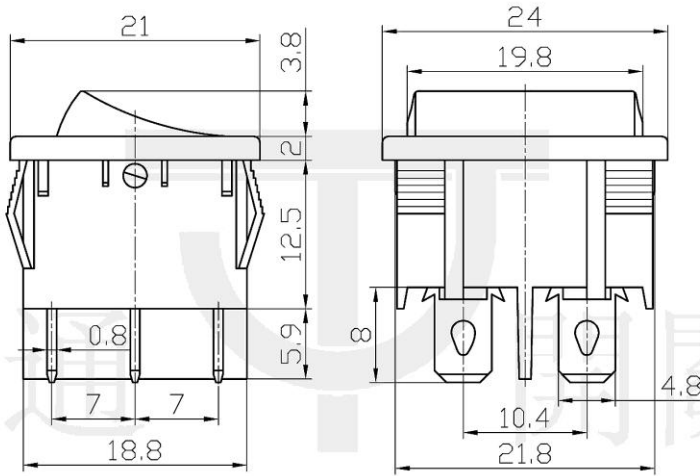

Mounting

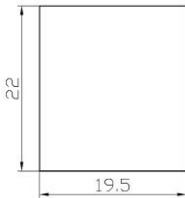

Circuitry

