



乐清市戴尔电子有限公司
YUEQING DAIER ELECTRONIC CO., LTD

承认书

SPECIFICATION FOR APPROVAL

产品名称: 钮子开关
PRODUCT NAME _____

产品型号: KN3C-101
PRODUCT NO _____

产品图号:
PRODUCT DRAWING NO _____

客户名称:
CUSTOMER NAME _____

客户料号:
CUST MATERIAL NO _____

戴尔确认 DAIER APPROVAL

编制/日期 ORGANIZER/DATE	审核/日期 CHECK/DATE	批准/日期 APPROVAL/DATE

客户确认 CUSTOMER APPROVAL

品质部门/签名/日期 QC DEPT /SIGN/DATE	技术部门/签名/日期 TECH DEPT /SIGN/DATE	确认/签名/日期 APPROVAL/SIGN/DATE

地址: 浙江省乐清市柳市镇西仁宕工业区
ADD: Add: Xirendang Industrial Zone ,Liushi Town Yueqing City, Zhejiang Province
电话 (TEL): 0577-27870727
传真 (FAX): 0577-27870727

	乐清市戴尔电子有限公司 YUEQING DAIER ELECTRON CO.,LTD	规格书 SPECIFICATION	编号 No.	
			版本号 SERSION	A0
产品名称 SERIES	钮子开关 TOGGLE SWITCH	产品型号 TYPE	KN3C	
日期 DATE	2021.4.20	页码 PAGE	2 / 9	

项目 ITEM	测试条件 TEST CONDITIONS	要求 REQUIREMENT
---------	----------------------	----------------

1 概述 GENERAL

- 1.1 系列 DESIGNATION: 钮子开关 TOGGLE SWITCH
- 1.2 型号 MODULE No.: KN3C-101
- 1.3 额定值 RATING: 15A 250VAC 20A 125VAC
- 1.4 使用温度 OPERATING TEMPERATURE RANGE: -25℃~85℃
- 1.5 贮存温度 STORAGE TEMPERATURE RANGE: -25℃ TO 55℃:

2. 外观与尺寸 APPEARANCE AND DIMENSIONS

2.1 外观 APPEARANCE: 无影响产品使用性能的缺陷.

There shall be no defects that affect the serviceability of the product.

2.2 标识 MARKING: 应有商标、型号、额定值、认证标志等标识.

There shall be trademark, module No., rating, license mark and other necessary mark on the switch body.

2.3 尺寸 DIMENSIONS: 应符合产品图. Shall conform to drawing.

3. 性能要求 PERFORMANCE

项目 ITEM	测试条件 TEST CONDITIONS	要求 REQUIREMENT
---------	----------------------	----------------

3.1 电气性能 ELECTRICAL PERFORMANCE:

3.1.1 接触电阻 CONTACT RESISTANCE	开关处于接通状态, 用微电阻测试仪或高精度线性毫欧计测量端子间的电阻 The switch to be made in "on" state and the resistance be measured between the two terminals with micro-resistance test instrument or high precision liner more-ohm meter.	20mΩ max
3.1.2 绝缘电阻 INSULATION RESISTANCE	触点间的绝缘和功能绝缘: 约500V的直流电压施加在处于断开状态的开关的两触点间和开关的不同极之间, 相同极性的导电件应连接在一起。施加电压1 分钟后进行测量 INSULATION RESISTANCE BETWEEN CONTACT AND OPERATIONAL INSULATION: A d.c. voltage of approximately 500V is applied between the open contacts of each pole of a switch and between the different poles of which all the parts is connected together, the measurement shall be made	1000MΩ min

	乐清市戴尔电子有限公司 YUEQING DAIER ELECTRON CO.,LTD	规格书 SPECIFICATION		编号 No.	
				版本号 SERSION	A0
产品名称 SERIES	钮子开关 TOGGLE SWITCH	产品型号 TYPE	KN3C		
日期 DATE	2021.4.20	页码 PAGE	3 / 9		

项目 ITEM	测试条件 TEST CONDITIONS	要求 REQUIREMENT
---------	----------------------	----------------

	after the voltage is applied for 1 min.	
3.1.3 介电强度 DIELECTRIC STRENGTH	<p>触点间和各极间的介电强度： 处于断开状态的开关的两触点间和开关的不同极之间，应能承受基本为正弦波形，频率为50或60赫兹的1500伏电压5秒钟无击穿或闪络现象。</p> <p>DIELECTRIC STRENGTH BETWEEN CONTACTS AND BETWEEN DIFFERENT POLES: A voltage of substantially sine wave form, with a frequency of 50Hz or 60Hz and the value of 1500v is applied for 5Seconds between the open contacts and the different poles.</p>	无击穿或闪络现象 No flashover or Breakdown shall occur
	<p>加强绝缘间的介电强度： 基本为正弦波形的、频率为50或60赫兹、数值为3000伏的电压施加在导电部件和覆在开关的易接触外表面的金属箔及易接触的金属部件之间5秒钟应无击穿或闪络现象发生。</p> <p>DIELECTRIC STRENGTH BETWEEN REINFORCE INSULATION: A voltage of substantially sine wave form, having a frequency of 50Hz or 60Hz and the value of 3000v is applied for 5 Seconds between and a metal foil covering the outer accessible surface and accessible metal parts.</p>	
3.1.4 开关的发热 HEATING	<p>开关首先在无电流通过的情况下，作20个操作循环，然后将操作件停留在最不利的“接通”位置，开关通以电流，其值为电阻性负载最大额定电流的1.06倍，试验电流至少维持一小时或维持到端子温度稳定。当每隔5分钟读取连续的三个读数变化不大于±2℃，即认为温度稳定。测得的温升不应超过45K。</p> <p>First of all, the switches are subjected to 20 operating cycles with no current flowing. Then the actuating member is left in the most unfavorable "ON" position and the switches are loaded with a current of 1.06 times the maximum rated current for resistive load. The current is maintained at least for one hour or until a</p>	<p>端子温升不超过45K； 操作件温度不超过105℃； 金属操作件温度不超过60℃。</p> <p>The temperature rise at the terminals shall not exceed 45K. The temperature of actuating members shall not exceed 60℃;</p>

	乐清市戴尔电子有限公司 YUEQING DAIER ELECTRON CO.,LTD	规格书 SPECIFICATION		编号 No.	
				版本号 SERSION	A0
产品名称 SERIES	钮子开关 TOGGLE SWITCH	产品型号 TYPE	KN3C		
日期 DATE	2021.4.20	页码 PAGE	4 / 9		

项目 ITEM	测试条件 TEST CONDITIONS	要求 REQUIREMENT
---------	----------------------	----------------

	constant temperature at the terminal is attained. A temperature is considered to be constant when three successive readings obtained at every 5min of which value indicate no change greater than $\pm 2^{\circ}\text{C}$.	
--	---	--

3.2 材料性能 MATERIAL PERFORMANCE:

3.2.1 开关材料的阻燃性： 灼热丝试验 RESISTANCE TO FIRE: GLOW WIRE TEST	保持、支持带电导体在其相对位置的非金属零件应能承受850℃的灼热丝试验，其他零件应能承受650℃的灼热丝试验。 For nonmetal parts which are in contact with, maintain or retain the live parts in position should be carried out the glow wire test at the 850℃. The other parts should be carried out the glow wire test at the 650℃.	5 无火焰产生或离开灼热丝后，火焰30秒内熄灭 No flame or the flame fire out in 30S when glow wire leave away.
3.2.2 开关材料的耐热性：球压试验 RESISTANCE TO HEAT: BALL PRESSURE TEST	保持、支持带电导体在其相对位置的非金属零件应能承受125℃的球压试验，其他零件应能承受75℃的球压试验。 For nonmetal parts which are in contact with, maintain or retain the live parts in position electrical should be carried out the ball pressure test at the 125℃. The other parts should be carried out the ball pressure test at the 75℃.	压痕直径 $\leq 2\text{mm}$ The diameter of the impassion shall not exceed 2 mm.
3.2.3 开关材料的耐漏电起痕特性 RESISTANCE TO TRACKING	在不同极的导电部件之间、导电部件与接地金属部件之间、导电部件与易接触的表面之间有特定的爬电路径的所有非金属部件应能通过175V的耐漏电起痕指数测试。 All non-metal parts for which a creep age path is specified between live parts of different polarity,	无击穿或闪络现象 No flashover or breakdown shall occur between live parts and earthed metal parts and between the live parts and accessible surfaces of a switch shall be carried out the proof tracking test of 175V.

3.3 机械性能 MECHANICAL PERFORMANCE:

	乐清市戴尔电子有限公司 YUEQING DAIER ELECTRON CO.,LTD	规格书 SPECIFICATION	编号 No.	
			版本号 SERSION	A0
产品名称 SERIES	钮子开关 TOGGLE SWITCH	产品型号 TYPE	KN3C	
日期 DATE	2021.4.20	页码 PAGE	5 / 9	

项目 ITEM	测试条件 TEST CONDITIONS	要求 REQUIREMENT
3.3.1 机械强度 MECHANICAL STRENGTH:	<p>将弹簧冲击器的释放能量校准到0.5Nm ± 0.04Nm,用弹簧冲击器对可触及的表面包括驱动元件进行冲击,对每一个认为薄弱的位置冲击三次。</p> <p>The spring-operated impact-test apparatus is calibrated to deliver an energy of 0.5Nm±0.04Nm Blows are applied to all accessible surfaces, including actuating members by the test apparatus. For all such surfaces three blows are applied to every point that is likely to be weak.First a pull of 15N shall be applied for 1 min to try to pull off the actuating member and secondly a push of 30N for 1 min is applied to all actuating member.</p>	<p>试验后不应有影响开关安全和使用的损伤。</p> <p>There shall be no damages to switch safety and usage</p>
3.3.2 操作性能 OPERATING PERFORMANCE:	<p>用尽可能慢的速度按动开关的按钮。</p> <p>To operate the actuating member of a switch as slowly as possible.</p>	<p>开关的动触点只能停留在“接通”和“断开”的位置,当按钮释放时,按钮会自动移动到或停留在动触点对应的位置。</p> <p>The moving contacts of a switch can come to rest only in the "on" and "off" position. When the actuating member is released, it shall move automatically or stay in the position corresponding to that of the moving contacts.</p>
3.3.3 插片端子的安装强度(6.3端子) THE STENGTH OF TABS:	<p>将96N的轴向压力和88N的轴向拉力依次无冲击地作用在开关的插片上。</p> <p>A axial push of 96N and a axial pull of 88N shall be applied in turn to the tabs of a switch without jerks.</p>	<p>开关的插片不应出现明显的位移和损伤。</p> <p>No significant displacement or damage shall occur.</p>
3.4 耐久性能ENDURANCE:		

	乐清市戴尔电子有限公司 YUEQING DAIER ELECTRON CO.,LTD	规格书 SPECIFICATION		编号 No.	
				版本号 SERSION	A0
产品名称 SERIES	钮子开关 TOGGLE SWITCH	产品型号 TYPE	KN3C		
日期 DATE	2021.4.20	页码 PAGE	6 / 9		

项目 ITEM	测试条件 TEST CONDITIONS	要求 REQUIREMENT
---------	----------------------	----------------

3.4.1 电气寿命 ELECTRICAL LIFE		
3.4.1.1 提高电压加速测试 INCREASE-VOLTAGE AT ACCELERATED SPEED:	测试电压APPLIED VOLTAGE: 1.15倍额定电压1.15 times of rated voltage 测试电压APPLIED VOLTAGE:278.5V 测试电流APPLIED CURRENT:15A 功率因数: 0.95±0.05 操作循环数: THE NUMBER OF OPRATING CYCLE: 100 环境温度AMBIENT TEMPERATURE: 25±10℃ 操作速率OPERATING RATE: 30次/分钟 30 operations per minute 操作速度OPERATING SPEED: 大约80mm/s 的线性速度Approximately 80mm/sfor lineal actions	1、所有的动作功能正 常。 2、通以额定电流，在周 围温度为25±10℃的条 件下进行温升测试，端 子温升不应超过55K。 3、能够承受3.1.3条要 求的75%的介电强度测 试。 1.Allactions function as normal; 2.The temperature rise test at the terminal carried out under rated current and ambient temperature of 25± 10℃. the temperature rise at the terminal does not exceed 55K. 3.Can subject to the dielectric strength test which the test voltage shall be 75% the corresponding test voltage specified in clause 3.1.3.
3.4.1.2 慢速测试 SLOW SPEED TEST:	测试电压APPLIED VOLTAGE: 额定电压rated voltage250V 测试电流APPLIED CURRENT:15A 功率因数: 0.95±0.05 操作循环数: THE NUMBER OF OPRATING CYCLE:100 环境温度AMBIENT TEMPERATURE: 25±10℃ 操作速率OPERATING RATE: 15次/分钟15 operations per minute 操作速度OPERATING SPEED: 大约20mm/s 的线性速度Approximately 20mm/sfor lineal actions	
3.4.1.3 加速测试 ACCELERATED SPEED TEST:	测试电压APPLIED VOLTAGE: 额定电压rated voltage: 250V 测试电流APPLIED CURRENT: 15A 功率因数: 0.95±0.05 操作循环数: THE NUMBER OF OPRATING CYCLE: 9800 环境温度AMBIENT TEMPERATURE: 25±10℃ 操作速率OPERATING RATE: 15次/分钟 15 operations per minute	

	乐清市戴尔电子有限公司 YUEQING DAIER ELECTRON CO.,LTD	规格书 SPECIFICATION		编号 No.	
				版本号 SERSION	A0
产品名称 SERIES	钮子开关 TOGGLE SWITCH	产品型号 TYPE	KN3C		
日期 DATE	2021.4.20	页码 PAGE	7 / 9		

项目 ITEM	测试条件 TEST CONDITIONS	要求 REQUIREMENT
---------	----------------------	----------------

	操作速度 OPERATING SPEED: 大约 80mm/s 的线性速度 Approximately 80mm/s for lineal actions	
--	---	--

3.5 焊接性能 SOLDERING PERFORMANCE:

3.5.1 可焊性试验 (6.3 端子) SOLDERING TEST:	端子顶部被浸入焊锡池中 2mm 深, 温度 $230 \pm 5^{\circ}\text{C}$, 时间 3 秒。 The tip of the terminal shall be dipped 2mm in the bath at temperature $230 \pm 5^{\circ}\text{C}$ for 3 sec.	浸入的部分 75% 以上表面将被锡覆盖。 A new uniform coating of solder shall cover a minimum of 75% of the surface being immersed.
---	--	---

3.5.2 耐焊接热试验 (6.3 端子) RESISTANCE TO SOLDERING HEAT TEST:	焊锡炉的方法: 焊锡炉的温度控制在 $260^{\circ}\text{C} \pm 5^{\circ}\text{C}$, 锅炉焊接的时间 5 ± 0.5 秒, 基板的厚度为 1.6mm。 SOLDER BATH MOTHOD: Solder temperature $260^{\circ}\text{C} \pm 5^{\circ}\text{C}$; Immersion time 5 ± 0.5 sec. the thickness of PCB 1.6mm. 手工焊接方法: 手工焊接的时候, 温度控制在 $350^{\circ}\text{C} \pm 5^{\circ}\text{C}$, 焊接的时间 5 ± 0.5 秒, 但不能在端子上施加异常力。 SOLDERING IRON MOTHOD: Control temperature $350^{\circ}\text{C} \pm 5^{\circ}\text{C}$; Application time 5 ± 0.5 sec; However excessive pressure shall not be applied to the terminal.	本体无变形, 能满足机械、电气性能要求。 Without distortion of case or excessive looseness of terminals, Electrical and mechanical characteristics shall be satisfied.
---	--	--

3.6、耐候性 Weather Ability

	乐清市戴尔电子有限公司 YUEQING DAIER ELECTRON CO.,LTD	规格书 SPECIFICATION	编号 No.	
			版本号 SERSION	A0
产品名称 SERIES	钮子开关 TOGGLE SWITCH	产品型号 TYPE	KN3C	
日期 DATE	2021.4.20	页码 PAGE	8 / 9	

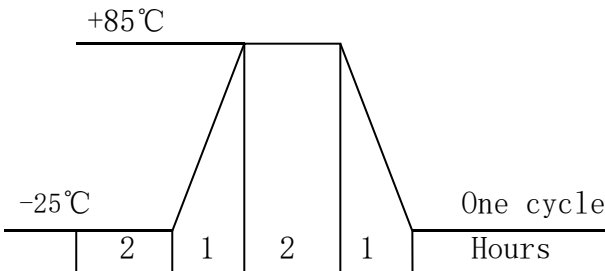
项目 ITEM	测试条件 TEST CONDITIONS	要求 REQUIREMENT
3.6.1 低温试验 COLD TEST	在(-25±3)℃的环境中放置16小时,再放在正常环境中1小时后进行测试。 Putting at (-25±3)℃ for 16 hours. Test after keeping in normal condition for 1 hours.	1、接触电阻≤20 mΩ Contact resistance: 50mΩ max 2、绝缘电阻≥1000MΩ Insulation resistance: 100MΩ Min 3、介电强度 Dielectric strength
3.6.2 高温试验 DRY HEAT TEST	在(85±2)℃环境中放置72小时,再放在正常环境中1小时后进行测试。 Putting at (85±2)℃ for 72 hours. Test after keeping in normal condition for 1 hour.	3.1触点间和各极间的介电强度:500V , 0.5mA,1分钟无击穿或闪络现象。 Dielectric strength between contacts and between different poles:500V , 0.5mA,1 minutes, No flashover or breakdown shall occur.
3.6.3 潮湿试验 DAMP HEAT, STEADY STATE	在温度为(40±2)℃,相对湿度为91%~95%RH的环境中放置96小时,再放在正常环境中1小时后进行测试。 Putting at (40 ± 2)℃ , 91% ~ 95%RH for 96hours,Test after keeping in normal condition for 1 hour.	3.2加强绝缘间的介电强度:1500V,0.5mA,1分钟无击穿或闪络现象。Dielectric strength between reinforce insulation:1500V , 0.5mA,1 minutes, No flashover or breakdown shall occur.
3.6.4 温度交变试验 TEMPERATURE CYCLING TEST	在如图示之环境中,循环5次后,再置于正常环境中,30分钟后进行测试。 In FIG. For 5 cycles, test after kept in normal condition for 30 minutes. <div style="text-align: center;">  </div>	4、无任何迹象显示机械及电气性能的损坏。 No sign of damage mechanical and electronic performance.
3.7 ROHS	ROHS 指令 ROHS Directive	compliant

标记	日期	姓名	变更内容
△			

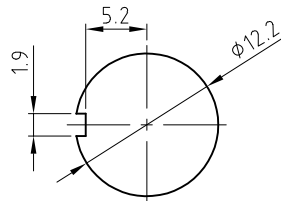
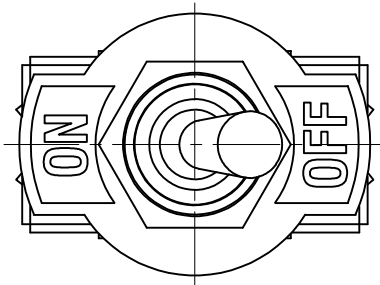
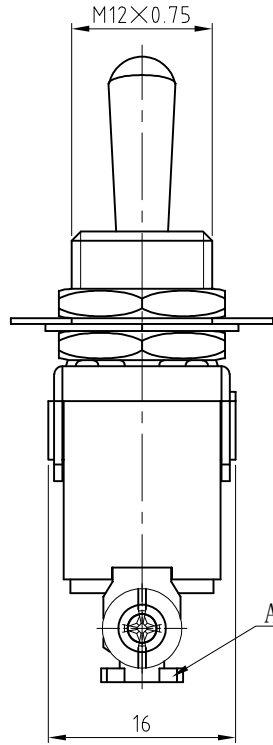
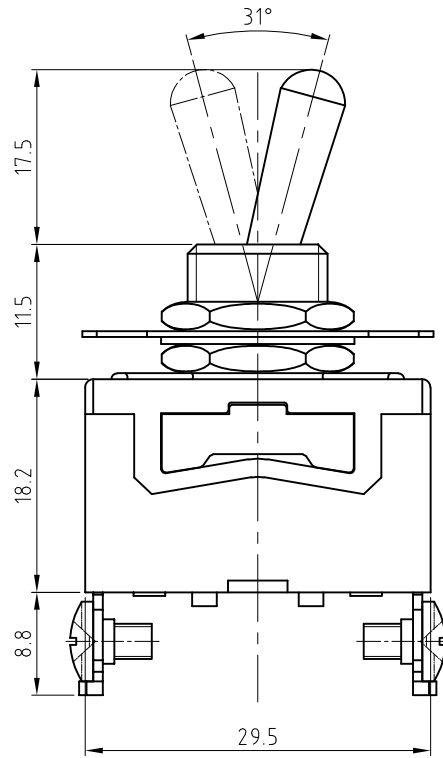

安装面板尺寸
PANEL CUT-OUT

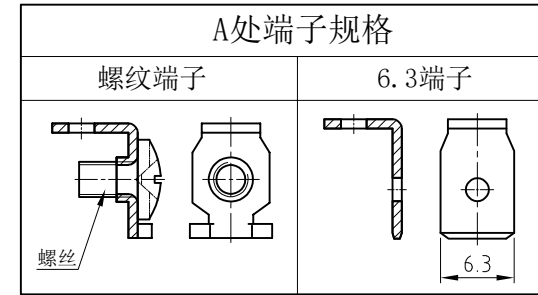

主要技术参数、性能
The Main Thchnology Performance

项目 Item	参数 Parameter
电路图 Circuit	
额定电流、电压 Rated voltage Rated current	15A 250V AC 20A 125V AC
绝缘电阻 Insulated resistance	≤100mΩ
接触电阻 Contact resistance	≤100mΩ
介电强度(极间) Dielectric strength	1500V AC/5S
电气寿命 Endurance	10000 Cycles

未注公差尺寸	线性尺寸	>0~6 ±0.05	名称	型号: KN3(C)		
	尺寸	>6~20 ±0.1		料号: KN3(C)-101		
设计	尺寸	>20~50 ±0.2	钮子开关	模具	单位: MM	比例: 1: 1
	审核	>50~100 ±0.4		编号	版本: A1	视角:
批准	尺寸	>100 ±0.8	生效时间	第 1 页 共 1 页		
	角度尺寸	±2°		乐清市戴尔电子有限公司 YUEQING DAIER ELECTRON CO.,LTD		