

## Automobile Switch

**Q-1073**

TYPE: **ASW-17D**

### SPECIFICATIONS

Rating: 35A 12V DC  
 Contact R: 50mΩ max  
 Insulation R: 500V DC 100MΩ min  
 Dielectric Strength: 1 Minute 1500V AC  
 Operating Temperature: -25°C ~ +85°C  
 Electrical Life: 10, 000 Cycles

Outline Drawing

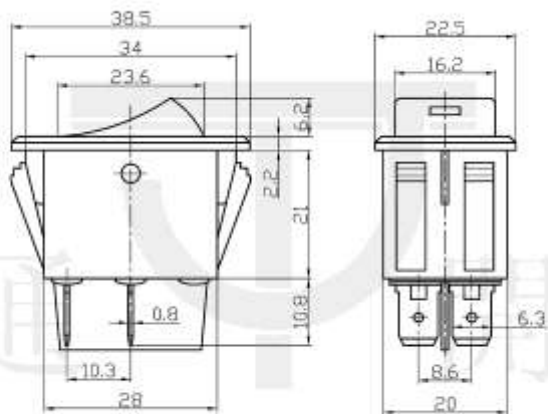

Mounting



Circuitry

