

# Single-pole Rocker Switch

**Q-1030**

TYPE: **RS-101-11C3**

Cap Marking



## SPECIFICATIONS

Contact Type: SPST  
 Rating: 15A 250V AC  
 Contact R: 35mΩ max  
 Insulation R: 500V DC 100MΩ min  
 Dielectric Strength: 1 Minute 1500V AC  
 Operating Temperature: -25°C ~ +85°C  
 Electrical Life: 10, 000 Cycles

Outline Drawing

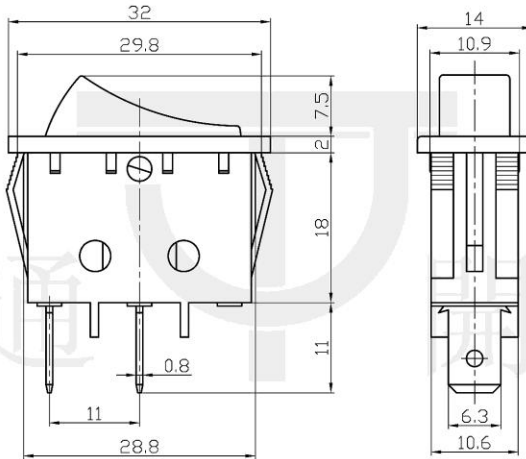

Mounting



Circuitry

