

# Illuminated Push-Button Switch

**Q-992**

TYPE: **BL-G109**

## SPECIFICATIONS

Rating: 5A 250V AC  
Contact R: 15mΩ max  
Insulation R: 500V DC 100MΩ min  
Dielectric Strength: 1 Minute 1500V AC  
Operating Temperature: -20°C ~ +80°C  
Operating force: 150gf ±50gf  
Electrical Life: 1, 000, 000 Cycles

Outline Drawing

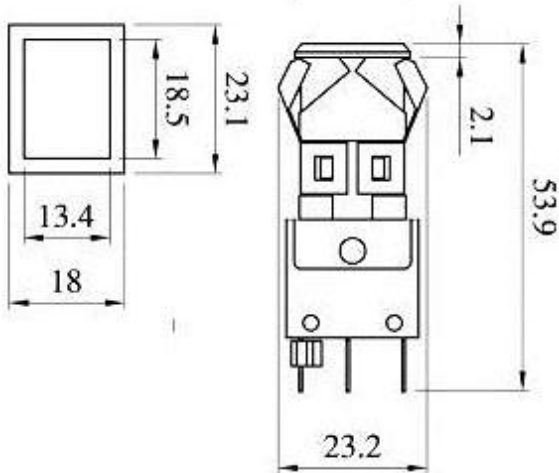

Mounting

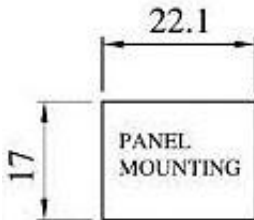

Circuitry